



Implementation and usage of Service Information (SI)

DVB Document A005 Rev.10

November 2022

DVB[®]

Contents

Intellectual Property Rights	7
Foreword.....	7
Modal verbs terminology	7
1 Scope	8
2 References	8
2.1 Normative references	8
2.2 Informative references	9
3 Definition of terms, symbols and abbreviations.....	10
3.1 Terms	10
3.2 Symbols	10
3.3 Abbreviations.....	10
4 Rules of operation	10
4.0 Introduction.....	10
4.1 Service Information (SI) table information.....	11
4.1.0 Overview	11
4.1.1 Network Information Table (NIT) information.....	11
4.1.2 Bouquet Association Table (BAT) information	12
4.1.3 Service Description Table (SDT) information	13
4.1.4 Event Information Table (EIT) information	13
4.1.4.0 General principles of EIT information.....	13
4.1.4.1 EIT Present/Following information	13
4.1.4.2 EIT Schedule information	15
4.1.4.2.1 EIT Schedule structure.....	15
4.1.4.2.2 EIT scrambling	16
4.1.5 Time and Date Table (TDT).....	16
4.1.6 Time Offset Table (TOT).....	16
4.1.7 Running Status Table (RST)	16
4.1.8 Stuffing Table (ST)	16
4.1.9 Transport Stream Description Table (TSDT).....	16
4.1.9.0 Use of the TSDT in distribution applications	16
4.1.9.1 Digital Satellite News Gathering (DSNG).....	17
4.1.10 Table update mechanism	17
4.1.11 Table segmentation	18
4.1.11.0 General rules.....	18
4.1.11.1 Generic segmentation rules	18
4.1.11.1.1 General rules	18
4.1.11.1.2 NIT and BAT	18
4.1.11.1.3 SDT and EIT	19
4.1.11.2 Segmentation rules for DVB-H and DVB-SH systems	19
4.1.11.2.1 General rules	19
4.1.11.2.2 NIT and BAT for DVB-SH and DVB-H	19
4.1.11.2.3 SDT for DVB-SH and DVB-H	20
4.2 SI descriptor allocation and usage	20
4.2.0 Overview	20
4.2.1 Descriptors of the Network Information Table (NIT)	21
4.2.1.0 NIT structure	21
4.2.1.1 First descriptor loop.....	21
4.2.1.1.1 Linkage descriptor	21
4.2.1.1.2 Multilingual network name descriptor	21
4.2.1.1.3 Network name descriptor	21
4.2.1.1.4 Cell list descriptor	22
4.2.1.1.5 Network change notify descriptor.....	22
4.2.1.1.6 URI linkage descriptor	22
4.2.1.2 Second descriptor loop	23

4.2.1.2.1	Delivery system descriptors	23
4.2.1.2.2	Service list descriptor	23
4.2.1.2.3	Frequency list descriptor	23
4.2.1.2.4	Cell frequency link descriptor	23
4.2.2	Descriptors of the Bouquet Association Table (BAT)	24
4.2.2.0	BAT structure	24
4.2.2.1	First descriptor loop	24
4.2.2.1.1	Bouquet name descriptor	24
4.2.2.1.2	CA identifier descriptor	24
4.2.2.1.3	Country availability descriptor	24
4.2.2.1.4	Linkage descriptor	24
4.2.2.1.5	Multilingual bouquet name descriptor	25
4.2.2.2	Second descriptor loop	25
4.2.2.2.1	Service list descriptor	25
4.2.3	Descriptors of the Service Description Table (SDT)	25
4.2.3.0	SDT structure	25
4.2.3.1	Announcement support descriptor	25
4.2.3.2	CA identifier descriptor	26
4.2.3.3	Component descriptor	26
4.2.3.4	Country availability descriptor	26
4.2.3.5	Data_broadcast_descriptor	26
4.2.3.6	Linkage descriptor	26
4.2.3.7	Mosaic descriptor	27
4.2.3.8	Multilingual service name descriptor	27
4.2.3.9	NVOD reference descriptor	27
4.2.3.10	Service descriptor	27
4.2.3.11	Service availability descriptor	27
4.2.3.11.0	General rules	27
4.2.3.11.1	Network Implementation Considerations	28
4.2.3.11.2	IRD implementation considerations	28
4.2.3.12	Service relocated descriptor	29
4.2.3.13	Telephone descriptor	29
4.2.3.14	Time shifted service descriptor	29
4.2.4	Descriptors of the Event Information Table (EIT)	30
4.2.4.0	EIT structure	30
4.2.4.1	CA identifier descriptor	30
4.2.4.2	Component descriptor	30
4.2.4.3	Content descriptor	31
4.2.4.4	Data_broadcast_descriptor	31
4.2.4.5	Extended event descriptor	31
4.2.4.6	Linkage descriptor	31
4.2.4.7	Multilingual component descriptor	32
4.2.4.8	Parental rating descriptor	32
4.2.4.9	PDC descriptor	32
4.2.4.10	Short event descriptor	32
4.2.4.11	Telephone descriptor	32
4.2.4.12	Time shifted event descriptor	33
4.2.5	Descriptors of the Time Offset Table (TOT)	33
4.2.5.0	TOT structure	33
4.2.5.1	Local time offset descriptor	33
4.2.6	Descriptors of the Program Map Table (PMT)	34
4.2.6.0	PMT structure	34
4.2.6.1	AC-3 descriptor	34
4.2.6.2	Adaptation field data descriptor	34
4.2.6.3	Ancillary data descriptor	34
4.2.6.4	Audio preselection descriptor	34
4.2.6.5	Data broadcast id descriptor	35
4.2.6.6	Enhanced AC-3 descriptor	35
4.2.6.7	Mosaic descriptor	35
4.2.6.8	Related content descriptor	35
4.2.6.9	Scrambling descriptor	35
4.2.6.10	Service move descriptor	35

4.2.6.11	Stream identifier descriptor	36
4.2.6.12	Subtitling descriptor	36
4.2.6.13	Supplementary audio descriptor	36
4.2.6.14	T2-MI descriptor	36
4.2.6.15	Teletext descriptor	36
4.2.6.16	VBI data descriptor.....	36
4.2.6.17	VBI teletext descriptor.....	36
4.2.6.18	DTS Descriptor.....	37
4.2.6.19	DTS-HD Descriptor.....	37
4.2.6.20	DTS Neural Descriptor	37
4.2.6.21	AC-4 descriptor	37
4.2.6.22	TTML subtitling descriptor	37
4.2.6.23	DTS-UHD descriptor.....	37
4.2.7	Other descriptors	37
4.2.7.1	Private data specifier descriptor.....	37
4.2.7.2	Stuffing descriptor	37
4.2.7.3	Data broadcast descriptor	38
4.2.7.4	Transport stream descriptor	38
4.2.7.5	Target region and target region name descriptors.....	38
4.2.7.5.1	General Description	38
4.2.7.5.2	Region selection by the IRD	39
4.2.7.6	URI linkage descriptor.....	39
4.2.7.7	FTA content management descriptor.....	39
4.2.7.8	Service Prominence Descriptor	40
4.2.8	ISO/IEC 13818-1 descriptors	40
4.2.9	Unknown descriptors.....	40
4.3	Program Specific Information (PSI) and DVB SI operational interaction states	40
4.4	Minimum repetition rates.....	41
4.4.1	Satellite and cable delivery systems	41
4.4.2	Terrestrial delivery systems	41
4.4.3	PSI repetition rates	42
4.5	Terrestrial systems	42
4.5.0	General rules	42
4.5.1	The use of alternative frequencies for multiplexes.....	42
4.5.2	Regional or local services	43
4.5.3	Hand-over.....	45
4.5.3.1	General description of the requirements	45
4.5.3.2	Hand-over by means of the frequency_list_descriptor	46
4.5.3.3	The occurrence of tuning failures	47
4.5.3.4	Hand-over methods with a reduced risk of tuning failures	48
4.5.3.4.0	General principles	48
4.5.3.4.1	Local SI insertion	49
4.5.3.4.2	Cell identification.....	49
4.5.3.4.3	Performance enhancement with GPS data	49
4.5.3.4.4	Two front-end solution	49
4.5.3.5	Performance considerations.....	50
4.5.3.6	Receiver guidelines for hand-over.....	50
4.5.3.6.1	Hand-over by means of the frequency_list_descriptor.....	50
4.5.3.6.2	Hand-over by means of cell identification	51
4.5.3.6.3	Hand-over by means of cell description and GPS position.....	51
4.5.3.6.4	Hand-over with two-front-end solutions.....	52
4.5.3.7	Additional linkage modes	52
4.5.3.8	Additional remarks	53
4.6	Text string formatting	53
4.6.0	General rules	53
4.6.1	Use of control codes in names.....	53
4.6.2	Use of control codes in text.....	54
4.6.3	Use of UTF-8	54
5	Applications	54
5.0	Introduction.....	54
5.1	NVOD services	54

5.2	Mosaic services.....	56
5.2.1	General considerations	56
5.2.2	Relationship between mosaic service and SI/PSI Tables	56
5.3	Transitions at broadcast delivery system boundaries.....	58
5.3.0	Introduction.....	58
5.3.1	Seamless transitions	58
5.3.2	Non-seamless transitions without re-multiplexing	59
5.3.3	Transitions with re-multiplexing	59
5.4	Announcements	60
5.5	Mosaic and picture-in-picture services using VVC subpictures	60
5.5.1	General considerations	60
5.5.2	Mosaic services using VVC subpictures	60
5.5.2.1	Usage of the VVC subpictures descriptor for mosaic services	60
5.5.2.2	Example signalling with several PMTs	61
5.5.2.3	Example signalling with only one PMT	62
5.5.3	Picture-in-picture services using VVC subpictures.....	63
5.5.3.1	Usage of the VVC subpictures descriptor for picture-in-picture services.....	63
6	Storage media.....	63
6.0	General principles	63
6.1	Program Association Table (PAT).....	64
6.2	Program Map Table (PMT)	64
6.3	SI tables (NIT, SDT, EIT, BAT, RST, TDT, TOT).....	64
6.4	Selection Information Table (SIT).....	64
6.5	Discontinuity Information Table (DIT)	64
	Annex A (informative): Bibliography.....	65
	Annex B (informative): Change History	66
	History	67

Intellectual Property Rights

Essential patents

IPRs essential or potentially essential to normative deliverables may have been declared to ETSI. The declarations pertaining to these essential IPRs, if any, are publicly available for **ETSI members and non-members**, and can be found in ETSI SR 000 314: *"Intellectual Property Rights (IPRs); Essential, or potentially Essential, IPRs notified to ETSI in respect of ETSI standards"*, which is available from the ETSI Secretariat. Latest updates are available on the ETSI Web server (<https://ipr.etsi.org/>).

Pursuant to the ETSI Directives including the ETSI IPR Policy, no investigation regarding the essentiality of IPRs, including IPR searches, has been carried out by ETSI. No guarantee can be given as to the existence of other IPRs not referenced in ETSI SR 000 314 (or the updates on the ETSI Web server) which are, or may be, or may become, essential to the present document.

Trademarks

The present document may include trademarks and/or tradenames which are asserted and/or registered by their owners. ETSI claims no ownership of these except for any which are indicated as being the property of ETSI, and conveys no right to use or reproduce any trademark and/or tradename. Mention of those trademarks in the present document does not constitute an endorsement by ETSI of products, services or organizations associated with those trademarks.

DECT™, **PLUGTESTS™**, **UMTS™** and the ETSI logo are trademarks of ETSI registered for the benefit of its Members. **3GPP™** and **LTE™** are trademarks of ETSI registered for the benefit of its Members and of the 3GPP Organizational Partners. **oneM2M™** logo is a trademark of ETSI registered for the benefit of its Members and of the oneM2M Partners. **GSM®** and the GSM logo are trademarks registered and owned by the GSM Association.

Foreword

This Technical Specification (TS) has been produced by Joint Technical Committee (JTC) Broadcast of the European Broadcasting Union (EBU), Comité Européen de Normalisation ELECTrotechnique (CENELEC) and the European Telecommunications Standards Institute (ETSI).

NOTE: The EBU/ETSI JTC Broadcast was established in 1990 to co-ordinate the drafting of standards in the specific field of broadcasting and related fields. Since 1995 the JTC Broadcast became a tripartite body by including in the Memorandum of Understanding also CENELEC, which is responsible for the standardization of radio and television receivers. The EBU is a professional association of broadcasting organizations whose work includes the co-ordination of its members' activities in the technical, legal, programme-making and programme-exchange domains. The EBU has active members in about 60 countries in the European broadcasting area; its headquarters is in Geneva.

European Broadcasting Union
CH-1218 GRAND SACONNEX (Geneva)
Switzerland
Tel: +41 22 717 21 11
Fax: +41 22 717 24 81

The DVB Project is an industry-led consortium of broadcasters, manufacturers, network operators, software developers, regulators and others from around the world committed to designing open, interoperable technical specifications for the global delivery of digital media and broadcast services. DVB specifications cover all aspects of digital television from transmission through interfacing, conditional access and interactivity for digital video, audio and data. The consortium came together in 1993.

Modal verbs terminology

In the present document "**shall**", "**shall not**", "**should**", "**should not**", "**may**", "**need not**", "**will**", "**will not**", "**can**" and "**cannot**" are to be interpreted as described in clause 3.2 of the [ETSI Drafting Rules](#) (Verbal forms for the expression of provisions).

"**must**" and "**must not**" are **NOT** allowed in ETSI deliverables except when used in direct citation.

1 Scope

The present document provides implementation guidelines for the use and implementation of the DVB Service Information (SI) coding in a DVB digital TV environment including satellite- cable- and terrestrial networks.

The guidelines are intended to be highly recommended rules for the usage of the DVB SI syntax specified in ETSI EN 300 468 [1]. As such, they facilitate the efficient and reliable implementation of basic user-interaction functions in Integrated Receiver-Decoders (IRD).

The rules apply to broadcasters, network operators as well as manufacturers.

The rules are specified in the form of constraints on the DVB SI streams or in terms of intended interpretation by IRDs.

The specification of these functions in no way prohibits IRD manufacturers from including additional features, and should not be interpreted as stipulating any form of upper limit to the performance.

The guidelines do not cover features related to user-interface details or advanced Electronic Program Guides (EPG). Such issues are left to the marketplace.

NOTE: It is highly recommended that the IRD should be designed to allow for future compatible extensions to the DVB SI syntax. All the fields "reserved" (for ISO), "reserved_future_use" (for ETSI), and "user defined" in the ETSI EN 300 468 [1] should be ignored by IRDs designed not to make use of them. The "reserved" and "reserved_future_use" fields may be specified in the future by the respective bodies, whereas the "user defined" fields will not be standardized.

The present document uses the terminology defined in ETSI EN 300 468 [1] and should be read in conjunction with that EN.

2 References

2.1 Normative references

References are either specific (identified by date of publication and/or edition number or version number) or non-specific. For specific references, only the cited version applies. For non-specific references, the latest version of the referenced document (including any amendments) applies.

Referenced documents which are not found to be publicly available in the expected location might be found at <https://docbox.etsi.org/Reference/>.

NOTE: While any hyperlinks included in this clause were valid at the time of publication, ETSI cannot guarantee their long term validity.

The following referenced documents are necessary for the application of the present document.

- [1] ETSI EN 300 468: "Digital Video Broadcasting (DVB); Specification for Service Information (SI) in DVB systems".
- [2] ISO/IEC 13818-1: "Information technology -- Generic coding of moving pictures and associated audio information: Systems".

2.2 Informative references

References are either specific (identified by date of publication and/or edition number or version number) or non-specific. For specific references, only the cited version applies. For non-specific references, the latest version of the referenced document (including any amendments) applies.

NOTE: While any hyperlinks included in this clause were valid at the time of publication, ETSI cannot guarantee their long term validity.

The following referenced documents are not necessary for the application of the present document but they assist the user with regard to a particular subject area.

- [i.1] ETSI EN 300 472: "Digital Video Broadcasting (DVB); Specification for conveying ITU-R System B Teletext in DVB bitstreams".
- [i.2] ETSI TS 101 162: "Digital Video Broadcasting (DVB); Allocation of identifiers and codes for Digital Video Broadcasting (DVB) systems".
- [i.3] ETSI EN 301 192: "Digital Video Broadcasting (DVB); DVB specification for data broadcasting".
- [i.4] ETSI TR 101 202: "Digital Video Broadcasting (DVB); Implementation guidelines for Data Broadcasting".
- [i.5] Void.
- [i.6] ETSI EN 300 744: "Digital Video Broadcasting (DVB); Framing structure, channel coding and modulation for digital terrestrial television".
- [i.7] ETSI TS 101 154: "Digital Video Broadcasting (DVB); Specification for the use of Video and Audio Coding in Broadcast and Broadband Applications".
- [i.8] ETSI EN 301 775: "Digital Video Broadcasting (DVB); Specification for the carriage of Vertical Blanking Information (VBI) data in DVB bitstreams".
- [i.9] ETSI EN 301 210: "Digital Video Broadcasting (DVB); Framing structure, channel coding and modulation for Digital Satellite News Gathering (DSNG) and other contribution applications by satellite".
- [i.10] ETSI EN 300 231: "Television systems; Specification of the domestic video Programme Delivery Control system (PDC)".
- [i.11] ISO/IEC 13818-3: "Information technology -- Generic coding of moving pictures and associated audio information -- Part 3: Audio".
- [i.12] ISO/IEC 11172-3: "Information technology -- Coding of moving pictures and associated audio for digital storage media at up to about 1,5 Mbit/s -- Part 3: Audio".
- [i.13] ETSI EN 300 743: "Digital Video Broadcasting (DVB); Subtitling systems".
- [i.14] ETSI EN 300 401: "Radio Broadcasting Systems; Digital Audio Broadcasting (DAB) to mobile, portable and fixed receivers".
- [i.15] ETSI TS 102 006: "Digital Video Broadcasting (DVB); Specification for System Software Update in DVB Systems".
- [i.16] Void.
- [i.17] ETSI TS 102 201: "Digital Video Broadcasting (DVB); Interfaces for DVB Integrated Receiver Decoder (DVB-IRD)".
- [i.18] ETSI ETS 300 801: "Digital Video Broadcasting (DVB); Interaction channel through Public Switched Telecommunications Network (PSTN) / Integrated Services Digital Networks (ISDN)".
- [i.19] ETSI EN 301 193: "Digital Video Broadcasting (DVB); Interaction channel through the Digital Enhanced Cordless Telecommunications (DECT)".

- [i.20] ISO 639-2: "Codes for the representation of names of languages -- Part 2: Alpha-3 code".
- [i.21] ETSI TS 103 205: "Digital Video Broadcasting (DVB); Extensions to the CI Plus™ Specification".
- [i.22] ETSI TS 102 034: "Digital Video Broadcasting (DVB); Transport of MPEG-2 TS Based DVB Services over IP Based Networks".
- [i.23] ETSI TS 103 286-2: "Digital Video Broadcasting (DVB); Companion Screens and Streams; Part 2: Content Identification and Media Synchronization".
- [i.24] ETSI TS 102 323: "Digital Video Broadcasting (DVB); Carriage and signalling of TV-Anytime information in DVB transport streams".
- [i.25] DVB BlueBook A174: "Digital Video Broadcasting (DVB); TTML subtitling systems".
- [i.26] ETSI TS 102 773: "Digital Video Broadcasting (DVB); Modulator Interface (T2-MI) for a second generation digital terrestrial television broadcasting system (DVB-T2)".
- [i.27] ETSI TS xxx yyy: "Digital Video Broadcasting (DVB); Implementation and Usage of AVMSD Signalling and Metadata".

3 Definition of terms, symbols and abbreviations

3.1 Terms

For the purposes of the present document, the terms given in ETSI EN 300 468 [1] and the following apply:

emitting site: collection of transmitters and/or repeaters gathered in one location

Multi Frequency Network (MFN) mode: geographical area is operated in MFN mode if the modulation parameters and frequencies used to broadcast a DVB transport stream differ from one emitting site to another

Single Frequency Network (SFN) mode: geographical area is operated in SFN mode if all emitting sites are synchronized and use the same frequency and modulation parameters to broadcast the same DVB transport stream

3.2 Symbols

Void.

3.3 Abbreviations

For the purposes of the present document, the abbreviations given in ETSI EN 300 468 [1] and the following apply:

ATSC	Advanced Television Systems Committee of the USA
AVMS-D	Audio Video Media Services Directive
DVB-H	DVB-Handheld
DVB-I	DVB-Internet
EITp/f	Event Information Table, present and following
GPS	Global Positioning System
MFN	Multi-Frequency Network

4 Rules of operation

4.0 Introduction

Clause 4 contains some recommendations on the usage of the Digital Video Broadcasting (DVB) Service Information (SI) syntax.

4.1 Service Information (SI) table information

4.1.0 Overview

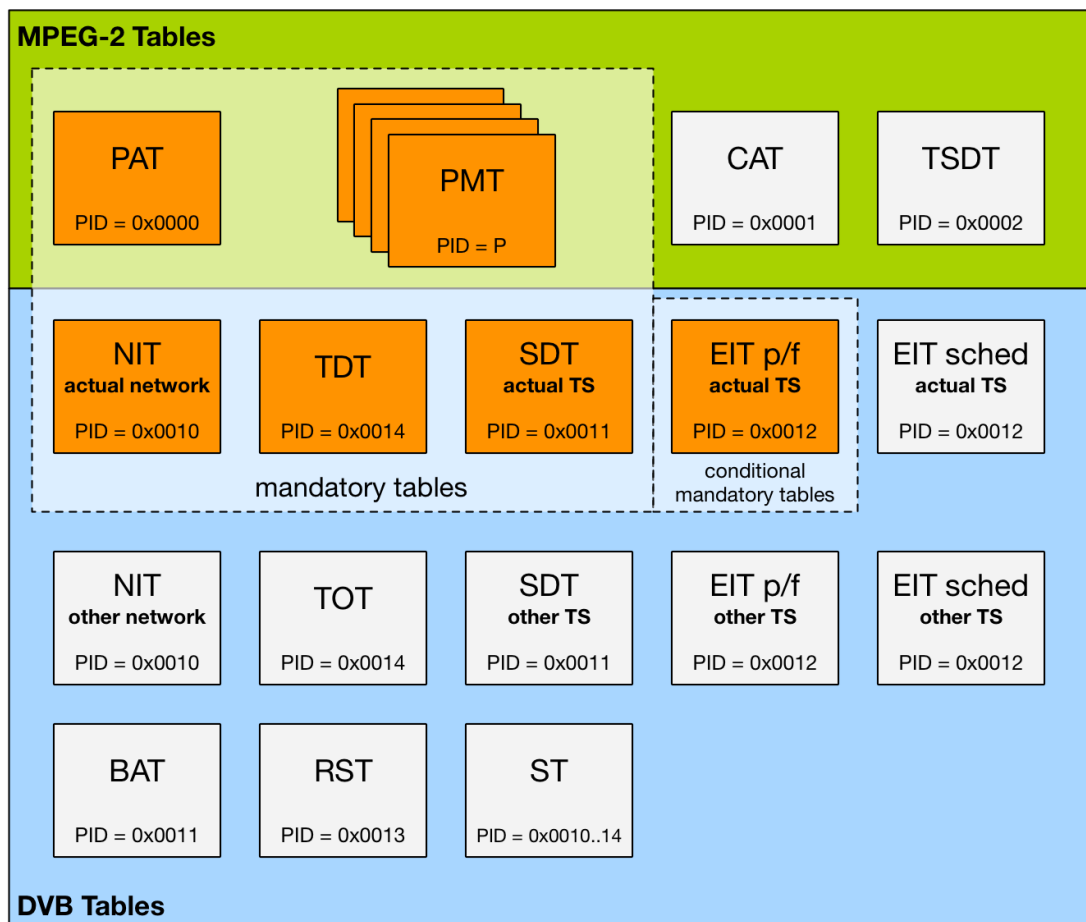

NOTE: EITp/f Actual is mandatory for all service types except those listed in clause 4.1.4.1.

Figure 1: SI table information

4.1.1 Network Information Table (NIT) information

The Network Information Table (NIT) provides a grouping of Transport Streams (TSs) and the relevant tuning information. The NIT could be used during set-up procedures of the IRD and the relevant tuning information may be stored in non-volatile memory. The NIT also could be used to signal changes of tuning information. The following rules apply to the NIT:

- transmission of the NIT is mandatory for the actual delivery system;
- the NIT describing the actual delivery system is valid if and only if it contains applicable delivery system descriptors for the actual delivery system. At some transitions of broadcast delivery system boundaries, the NIT carried in a TS is allowed to be invalid, and to describe an earlier network in the broadcast chain. In this case, a different mechanism has to be selected by the IRD to obtain the relevant tuning information for the actual delivery system. More information is provided in clause 5.3;
- if a valid NIT for the actual delivery system is present in the SI bit stream then it shall list all TSs of the actual delivery system;
- the SI stream shall have at least 8 TS packets per 10 s carrying NIT data or NULL packets. This rule simplifies the replacement of the NIT at broadcast delivery system boundaries. With the simple replacement mechanism, local frequency control is possible with relatively low cost equipment.

The SI uses two labels related to the concept of a delivery system, namely the `network_id` and the `original_network_id`. The latter is intended to support the unique identification of a service, contained in a TS, even if that TS has been transferred to another delivery system than the delivery system where it originated. A TS can be uniquely referenced through the path `original_network_id/transport_stream_id`.

Each `service_id` shall be unique within each `original_network_id`. Therefore the combination of `service_id` and `original_network_id` uniquely identifies a service. A service may be transmitted in multiple TS. Each unique instance of a service can be uniquely referenced through the path `original_network_id/transport_stream_id/service_id` (see ETSI EN 300 468 [1]). The `network_id`, thus, is not part of this path.

When a TS containing a service is transferred to another delivery system, only the `network_id` changes, whereas the `original_network_id` remains unaffected.

By way of example, consider the following, where two services (A and B), which originate in two different delivery systems and happen to have the same `service_ids` and `transport_stream_ids`, are transferred to a new delivery system. In this example, the two services are located on different TSs in the new network. If the two services were being combined onto the same TS, then it would be necessary to modify the identification of the services, since the same `service_id` value cannot be assigned to more than one service within a TS, and only one `original_network_id` can be associated with a TS (see clause 5.3 for further discussion on transitions at broadcast delivery system boundaries).

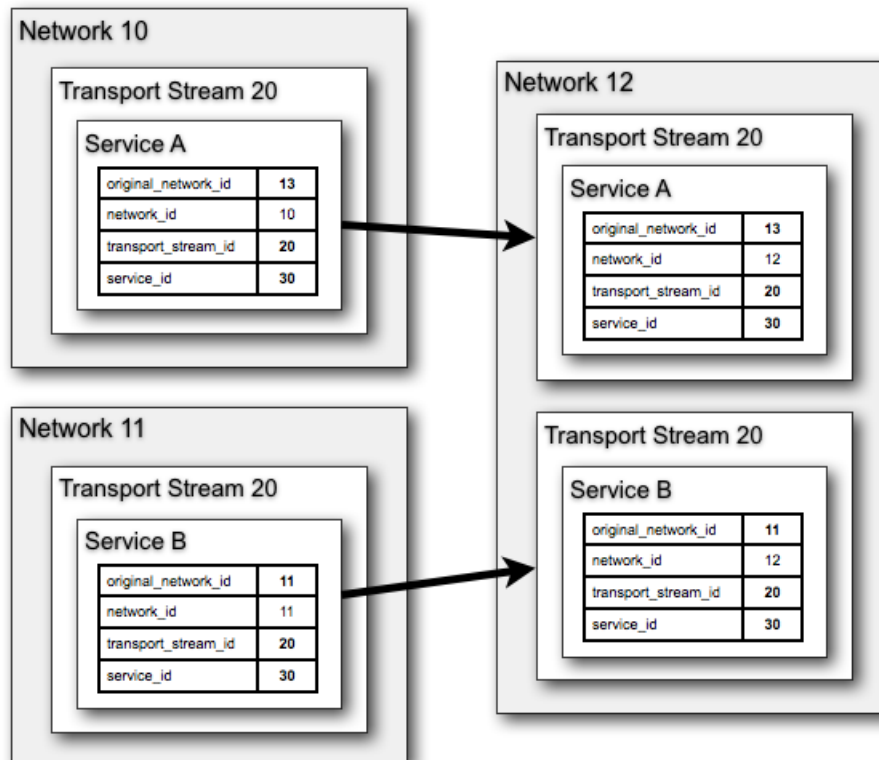

Figure 2: Transfer to a new delivery system

4.1.2 Bouquet Association Table (BAT) information

The BAT provides a grouping of services which serves as one basis on which an IRD presents the available services to a user. Transmission of the BAT is optional. The following rule improves the consistency in the SI bit streams and simplifies the processing in the IRDs.

The SI bit stream shall list in each BAT sub-table all the services belonging to that bouquet.

NOTE: One service may belong to more than one bouquet. This rule creates consistency across the different TSs which are accessible to the IRD.

If it is intended for the IRD to present service information to the user grouped in bouquets, then it would be beneficial to ensure that every service is listed in one or more bouquets, or some services will be omitted from this method of presentation. A bouquet may group together services from more than one TS, which could even be carried in different networks. The IRD's access to information on all the services of a bouquet would be facilitated if all the services referred to in the BAT were listed in the Service Description Table (SDT). Similarly, the IRD's access to these services is facilitated if NIT information is given for all TSs in which services of the bouquet occupy capacity.

4.1.3 Service Description Table (SDT) information

The SDT is used to list the names and other parameters of the services within TSs. For each TS a separate SDT sub-table exists. The following rules apply in order to improve the acquisition of services:

- the transmission of the SDT for the actual TS is mandatory;
- the SI bit stream should list in the SDT of a particular TS all the services of that TS.

In addition:

- any SDT for another TS than the actual one (i.e. with table_id = 0x46) should list all the services of that TS;
- it is strongly recommended that service_ids, once assigned to a specific service within a network, remain unchanged in order to enable IRDs to implement features like favourite channel lists, etc.
- the values of the EIT_present_following_flag and the EIT_schedule_flag fields should match the transmission of the corresponding EIT sub_tables; for rules on the transmission of EIT sub_tables, see clause 4.1.4.

4.1.4 Event Information Table (EIT) information

4.1.4.0 General principles of EIT information

The Event Information Table (EIT) is used to transmit information about present, following and further future events. For each service a separate EIT sub-table exists.

4.1.4.1 EIT Present/Following information

The following rule simplifies the acquisition of the EIT Present/Following information. The SI specification [1] states that an EIT section has a maximum size of 4 096 bytes.

EIT Present/Following shall be transmitted for all services, except when the service_type field takes any of the following values:

- teletext service (service type 0x03)
- mosaic service (service type 0x06)
- DVB SRM service (service type 0x08)
- data broadcast service (service type 0x0C)
- RCS Map (service type 0x0E)
- RCS FLS (service type 0x0F)
- DVB MHP service (service type 0x10)

NOTE: Although transmission of EIT Present/Following is not required for these services, it may still be transmitted when appropriate.

If the SI bit stream contains an EIT Present/Following under the above rules, it shall be encoded according to the following rules:

- a) The SI bit stream shall have two sections of EIT Present/Following and should indicate this in the SDT in the corresponding EIT_present_following_flag.

- b) It shall have an EIT Present/Following with the section_number 0x00 reserved for the description of the present event, and section_number 0x01 for the following event. Except for an NVOD reference service, where the EIT Present/Following may have more than one event description per section, and may have more than two sections in the EIT Present/Following.
- c) The SI bit stream shall have maximum of 4 096 bytes to describe a single event in a section.

The organization of the EIT Present/Following is based on the concept of present and following events. Which event is the present one can be determined using the following scheme:

- a) at each instant in time, there is at most one present event;
- b) when there is a present event, this event shall be described in section 0 of the EIT Present/Following;
- c) when there is no present event (e.g. in the case of a gap in the schedule) an empty section 0 of the EIT Present/Following shall be transmitted;
- d) the running_status field in the description of the present event shall be given the interpretation in table 1;

Table 1: running_status of the present event

undefined	No information except the nominal status is provided. IRDs and recording devices shall treat the present event as running.
running	IRDs and recording devices shall treat the present event as running.
not running	IRDs and recording devices shall treat the present event as not running. In other words, this event is nominally the present one, but at this time has either not started or already ended.
pausing	IRDs and recording devices shall treat the present event as pausing. In other words, this event is nominally the present one and has already started, but at this time the material being broadcast is not a part of the event itself. The transmission of event material shall resume at a later time.
starts in a few seconds	IRDs and recording devices shall prepare for the change of event status to "running" in a few seconds.
service off-air	IRDs and recording devices shall treat the present event as being off-air. However the service may provide an interactive application to cover the off-air period.

- e) at each point in time, there shall be at most one following event;
- f) if a following event exists, it shall be described in section 1 of the EIT Present/Following;
- g) if no following event exists, an empty section 1 of the EIT Present/Following shall be transmitted;
- h) the running_status field in the definition of the following event shall be given the following interpretation.

Table 2: running_status of the following event

undefined	No information except the nominal status is provided. IRDs and recording devices shall treat the following event as not running.
running	Not allowed.
not running	IRDs and recording devices shall treat the following event as not running.
pausing	This status is intended to indicate that the "following" event has been running at some time, but is now overlapped by another event. In such a case, during the whole time that the "following" event has status "pausing", one and the same overlapping event shall be encoded in section 0 of the EIT Present/Following. Furthermore, an event which has the status "pausing" shall acquire the status "running" at a later time, then replacing the overlapping event in section 0 of the EIT Present/Following.
starts in a few seconds	IRDs and recording devices shall prepare for the status of the following event to change to running within a few seconds.
service off-air	IRDs and recording devices shall treat the following event as being off-air. However the service may provide an interactive application to cover the off-air period.

The duration of an event as encoded in the field duration of the EIT shall also include the duration of all times when the event has the status "not running" or "paused". The start time of an event as encoded in the field start_time of the EIT shall be the start time of the entire event, i.e. not the start time after the pause has finished.

NOTE 1: The start time of one event plus its duration may be smaller than the start time of the following event. In other words, gaps between events are allowed. In such a case, the following event is considered to be the event scheduled to begin after the gap.

This event is encoded in section 1 of the EIT Present/Following.

NOTE 2: The start time and duration are scheduled times. Some broadcasters may update this information if the schedule is running late, whereas others may prefer to keep the indicated start time unchanged, e.g. to avoid having an event called "The News at 8" from being indicated as starting at 8:01:23, instead of 8:00:00.

4.1.4.2 EIT Schedule information

4.1.4.2.1 EIT Schedule structure

The EIT Schedule information is structured in such a way that it is easy to access the EIT data in a flexible manner. The EIT Schedule Tables shall obey the following rules:

- a) the EIT/Schedule is distributed over 16 table_ids, being 0x50 to 0x5F for the actual TS, and 0x60 to 0x6F for other TSs, which are ordered chronologically;
- b) the 256 sections under each sub-table are divided into 32 segments of 8 sections each. Segment #0, thus, comprises sections 0 to 7, segment #1 section 8 to 15, etc.;
- c) each segment contains information about events that start (see below) anywhere within a three-hour period;
- d) the information about separate events is ordered chronologically within segments;
- e) if only $n < 8$ sections of a segment are used, the information shall be placed in the first n sections of the segment. To signal that the last sections of the segment are not used, the value $s_0 + n - 1$, where s_0 is the first section number of the segment, shall be encoded in the field `segment_last_section_number` of the EIT header. As an example, if segment 2 contains only 2 sections, the field `segment_last_section_number` shall contain the value $8 + 2 - 1 = 9$ in those two sections;
- f) segments that contain all their sections shall have the value $s_0 + 7$ encoded in the field `segment_last_section_number`;
- g) entirely empty segments shall be represented by an empty section, (i.e. a section which does not contain any loop over events) with the value $s_0 + 0$ encoded in the field `segment_last_section_number`;
- h) the placing of events in segments is done referring to a time t_0 .
 t_0 is "last midnight" in Universal Time Coordinated (UTC) time.
Suppose, for instance, that it is 5.00 PM in the time zone UTC-6. It is then 11.00 PM in the time zone UTC+0, which makes it 23 hours since "last midnight". Therefore, t_0 is 6.00 PM the previous day in UTC-6;
- i) segment #0 of table_id 0x50 (0x60 for other TSs) shall contain information about events that start between midnight (UTC Time) and 02:59:59 (UTC Time) of "today". Segment #1 shall contain events that start between 03:00:00 and 05:59:59 UTC time, and so on. This means that the first sub-table (table_id 0x50, or 0x60 for other TSs) contains information about the first four days of schedule, starting today at midnight UTC time;
- j) the field `last_section_number` is used to indicate the end of the sub-table. Empty segments that fall outside the section range indicated by `last_section_number` shall not be represented by empty sections;
- k) for all sections used in the delivery of EIT/Schedule information for a particular service the field `last_table_id` is used to indicate the last table_id used in the delivery of EIT schedule information for that service. Empty segments that fall outside the table_id range indicated by `last_table_id` shall not be represented by empty sections;
- l) segments that correspond to events in the past may be replaced by empty segments (see rule g);
- m) the `running_status` field of event definitions contained in the EIT/Schedule shall be set to either undefined (0x00) or service off air (0x05). The use of service off-air (0x05) indicates the event represents a period when the service is off-air;

- n) EIT/Schedule tables are not applicable to NVOD Reference Services, since these have events with undefined start times;
- o) EIT/Schedule tables should only be present for a service when the EIT_schedule_flag in the corresponding SDT is set to 1.

4.1.4.2.2 EIT scrambling

The EIT Schedule Tables may be scrambled. In order to provide an association with the Conditional Access (CA) streams, it is necessary to allocate a service_id (= MPEG-2 program_number) which is used in the Program Specific Information (PSI) to describe scrambled EIT Schedule Tables.

The EIT is identified in the Program Map Table (PMT) section for this service_id as a programme consisting of one private stream, and this PMT section includes one or more CA_descriptors to identify the associated CA streams. The service_id value 0xFFFF is reserved in DVB applications for this purpose.

4.1.5 Time and Date Table (TDT)

The Time and Date Table (TDT) transmits the actual UTC-time coded as Modified Julian Date (MJD). It may be used to synchronize the internal clock of an IRD. The TDT shall be transmitted, and with a repetition rate as defined in clause 4.4. The encoded time is intended to be valid when the section becomes valid according to figure 3.

4.1.6 Time Offset Table (TOT)

The TOT transmits the actual UTC-time including also time offset information coded as MJD. It may be used to synchronize the internal clock of an IRD. Transmission of the TOT is optional, but if present it shall be transmitted with a repetition rate as defined in clause 4.4. The encoded time is intended to be valid when the section becomes valid according to figure 3.

4.1.7 Running Status Table (RST)

Running status sections are used to rapidly update the running status of one or more events. Running status sections are sent out only once, at the time the status of an event changes, unlike other SI Tables which are normally repetitively transmitted. Thus there does not exist any update mechanism for RSTs.

At the moment an RST is transmitted to update the running status of an event, it invalidates the running status of that event, transmitted previously by the EIT Present/Following. The following time the EIT is transmitted, it shall contain the updated running status bits.

The intended use of this optional mechanism is to enable IRDs or recording devices to implement highly accurate switching to the beginning of events by setting up a filter on Running Status Tables and waiting for the occurrence of the RST section containing the event.

4.1.8 Stuffing Table (ST)

A stuffing section may occur in anywhere that a section belonging to an SI Table is allowed. Stuffing Tables may be used to replace or invalidate either sub-tables or complete SI Tables. In order to guarantee consistency, all sections of a sub-table shall be stuffed. It is not allowed to replace some sections of a sub-table by stuffing some sections while keeping others.

4.1.9 Transport Stream Description Table (TSDT)

4.1.9.0 Use of the TSDT in distribution applications

The transmission of the Transport Stream Description Table (TSDT) (ISO/IEC 13818-1 [2]) within DVB transport streams is optional but recommended. The decoding of the TSDT is optional. Decoders which are designed to support different MPEG based systems should be able to decode and interpret this table.

If the TSDT is present, at least one transport_stream_descriptor shall be present at the beginning of the descriptor loop. The compatibility of a transport stream with different MPEG-based systems shall be indicated by the presence of more than one transport_stream_descriptor.

If the transport stream is compatible with DVB, the following descriptors are allowed in the descriptor loop and shall appear after the `transport_stream_descriptor`:

- `linkage_descriptor`;
- `private_data_specifier_descriptor` followed by private descriptors; and
- `private_data_indicator_descriptor` (ISO/IEC 13818-1 [2]).

4.1.9.1 Digital Satellite News Gathering (DSNG)

For DSNG transmissions the Transport Stream Description Table (TSDT) shall be present in the bitstream. The TSDT descriptor loop shall contain the `transport_stream_descriptor` with the ASCII codes for "DSNG" in the text field.

At least one `DSNG_descriptor` shall be present in the TSDT. The semantics for the DSNG descriptor are defined in ETSI EN 301 210 [i.9].

In pure DSNG transmissions only the PAT, PMT and TSDT need to be present.

If compatibility with consumer IRDs is required, at least all mandatory SI-tables and descriptors shall be present in the bitstream and the first TSDT descriptor shall contain "DVB" while the second contains "DSNG".

4.1.10 Table update mechanism

The section syntax used in the DVB Service Information (SI) supports various signalling mechanisms for SI contents updates.

The update of a section with the `section_syntax_indicator` flag set to 1, will be signalled by incrementing the `version_number` field. The update will be effective immediately following the last byte of the `CRC_32` of the new version of the section, so the `current_next_indicator` shall always have the value of "1". Sections with `current_next_indicator` set to "0" are never transmitted.

NOTE: Due to transmission errors or operational changes, the version number may not always increment by one. Due to this any change of the version number should be seen as an indication for an update to the table.

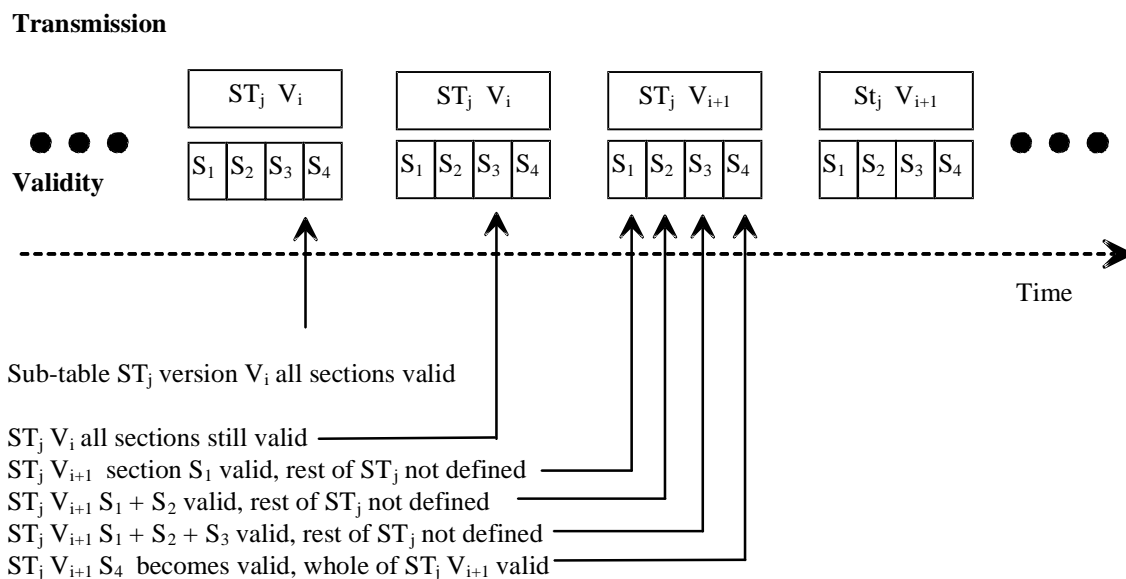

NOTE 1: Sections of a sub_table do not have to be transmitted in number order.

Some IRD implementations may acquire data with improved efficiency if the sections of a sub-table are transmitted in numerical order. However, a broadcaster may not transmit the sections in order owing to random access considerations.

NOTE 2: In transition phases, where $ST_j V_{i+1}$ is not yet valid because not all sections have been received for V_{i+1} , and $ST_j V_i$ is already not defined, receivers may choose not to discard and continue to use some information from sections received for V_i until the whole of $ST_j V_{i+1}$ has become valid. This scheme may be particularly useful for sub_tables with long cycle times like for example the EIT Schedule.

Figure 3: Timing of table updates and validity

4.1.11 Table segmentation

4.1.11.0 General rules

The generic table segmentation rules in clause 4.1.11.1 are designed to ensure maximum compatibility with legacy receivers. DVB-H and DVB-SH systems table segmentation rules are described in clause 4.1.11.2.

It should be noted that most SI tables can be conveyed in multiple sections and this shall be supported. In particular NIT, BAT and SDT tables are likely to increase from one to multiple sections as a platform grows over time. Equipment shall also support EIT schedule tables with multiple sections per segment.

4.1.11.1 Generic segmentation rules

4.1.11.1.1 General rules

Use of private data specifier and private data indicator descriptors shall obey the rules in clause 4.2.7.1.

4.1.11.1.2 NIT and BAT

All the first loop descriptors shall be conveyed in the one or more sections of the sub_table starting in the first section. No transport stream loops shall be started until the first loop descriptors have been completed. Therefore the initial sections shall have the transport_stream_loop_length set to zero if the first loop descriptors continue in the next section.

The network_descriptors_length and bouquet_descriptors_length fields shall be set according to the number of bytes of the loop contained in the section.

The description of a particular transport stream in a BAT or NIT shall not be split across more than one section. Therefore the same pair of transport_stream_id and original_network_id shall not appear in the transport stream loop of more than one section of a particular sub_table. This limits the maximum size of a second descriptor loop to 1 002 bytes.

4.1.11.1.3 SDT and EIT

The description of a particular service in an SDT shall not be split across more than one section. Therefore the same `service_id` shall not appear in more than one section of a particular `sub_table`.

Similarly for EIT the description of an event shall not be split across more than one section. Therefore an `event_id` shall not appear in more than one section of a particular `sub_table`.

These constraints limit the size of the EIT or SDT descriptor loop to that which can fit within the maximum section size for the respective table.

4.1.11.2 Segmentation rules for DVB-H and DVB-SH systems

4.1.11.2.1 General rules

Use of private data specifier and private data indicator descriptors shall obey the rules in clause 4.2.7.1.

4.1.11.2.2 NIT and BAT for DVB-SH and DVB-H

All the network descriptors shall be conveyed in the one or more sections of the `sub_table` starting in the first section. No transport stream loops shall be started until the first loop descriptors have been completed. Therefore the initial sections shall have the `transport_stream_loop_length` set to zero if the network descriptors continue in the next section.

The `network_descriptors_length` and `bouquet_descriptors_length` fields shall be set according to the number of bytes of the loop contained in the section.

An instance of the transport stream loop for a particular transport stream in a BAT or NIT may be split across more than one section. Therefore the same pair of `transport_stream_id` and `original_network_id` may appear in the transport stream loop of more than one section of a particular `sub_table`. In this case, the following rules apply:

- a) The `transport_stream_loop_length` field in the current section shall be set according to the number of bytes of the loop contained in the section.
- b) The description of a transport stream shall be encoded in numerically sequential sections.
- c) No other description of a transport stream shall be encoded before the completion of the current transport stream description. Therefore, descriptors for the next transport stream shall not be encoded before the current transport stream has been fully described.

The most efficient packing of the descriptors to reduce the number of sections is not mandated.

EXAMPLE: The NIT is constituted of a single TS, and both the network descriptors loop and the description of the single transport stream span approximately 2,5 sections each, therefore the NIT is conveyed in 5 successive sections:

- Section 0:
 - Content:
 - beginning of network descriptors loop, of length 800 bytes.
 - Structure:
 - `network_descriptors_length` = 800 bytes;
 - `transport_stream_loop_length` = 0.
- Section 1:
 - Content:
 - follow-up of network descriptors loop, of length 1 000 bytes.
 - Structure:
 - `network_descriptors_length` = 1 000;

- transport_stream_loop_length = 0.
- Section 2:
 - Content:
 - remainder of network descriptors loop, of length 200 bytes;
 - start of transport stream loop, of length 600 bytes.
 - Structure:
 - network_descriptors_length = 200;
 - transport_stream_loop_length = 600;
 - transport_descriptors_length = 594.
- Section 3:
 - Content:
 - Follow-up of transport_stream_loop, of size 1 000 bytes.
 - Structure:
 - network_descriptors_length = 0;
 - transport_stream_loop_length = 1 000;
 - transport_descriptors_length = 994.
- Section 4:
 - Content:
 - remainder of transport stream loop, of length 300 bytes.
 - Structure:
 - network_descriptors_length = 0;
 - transport_stream_loop_length = 300;
 - transport_descriptors_length = 294.

4.1.11.2.3 SDT for DVB-SH and DVB-H

The description of a particular service in an SDT may be split across more than one section. Therefore the same combination of service_id and original_network_id may appear in more than one section of a particular sub_table.

If the description of a service is split across more than one section, the same rules as listed in clause 4.1.11.2.2 shall apply.

4.2 SI descriptor allocation and usage

4.2.0 Overview

Clause 4.2 specifies the location where descriptors can be expected in a SI bit stream, and identifies which descriptors may occur multiple times. Descriptors which contain fundamental SI data are identified as recommended to be decoded by the IRD. The interpretation of other descriptors by the IRD, including those not listed in clause 4.2, is optional.

4.2.1 Descriptors of the Network Information Table (NIT)

4.2.1.0 NIT structure

The NIT is organized as follows:

```

/* header ...*/
for (i = 0; i < N; i++) { /* 1st descriptor loop */
    descriptor()
}
for (i = 0; i < N; i++) {
    /* loop over transport streams */
    transport_stream_id
    original_network_id
    for (j = 0; j < M; j++) { /* 2nd descriptor loop */
        descriptor()
    }
}
/* CRC etc. */

```

4.2.1.1 First descriptor loop

4.2.1.1.1 Linkage descriptor

This descriptor is used to give a link to a service or TS. If it appears in the first descriptor loop of the NIT it links to a service that is attached to the network operator. It could for example point to the "Paris Cable Info channel" and to "Paris Cable Text". This descriptor is allowed more than once in the first descriptor loop of the NIT. Transmission of this descriptor is optional. The meaning of the descriptor when it occurs in the first descriptor loop of the NIT depends on the value of the linkage_type. If the linkage_type is:

- a) 0x01, it refers to a service that contains information about the network. An example of the intended use is for the IRD to switch to the information service when the user requests additional information about the network;
- b) 0x02, it refers to an Electronic Program Guide (EPG) for the network. Note that the IRD can only make use of this type of linkage if it can decode the EPG service. The present document does not specify the contents of such a service;
- c) 0x04, it refers to a TS which carries comprehensive Service Information. The SI carried in the referenced TS includes at least all the SI information available on all other TSs of the network;
- d) 0x08, it refers to a service in a terrestrial network to which the receiver might tune to if the actual service is no longer receivable under its service_id. Valid links for the actual service can be identified by the initial service id. The hand-over_type indicates whether the linkage_descriptor is used to link to an identical service in a neighbouring country, to a local variation of the service or an associated service;
- e) 0x09, it refers to a transport stream carrying a System Software Update service, see ETSI TS 102 006 [i.15];
- f) 0x0A, it refers to a transport stream carrying a System Software Update BAT or NIT with detailed signalling information about System Software Update services, see ETSI TS 102 006 [i.15].

The meaning of other values of linkage_type is not defined in this context. Note that the linkage_type does not indicate the service_type of the referenced service. An example of the intended use of the linkage descriptor is that an IRD user interface could include a mechanism like "info about the network" which would make the IRD tune to the linked service after the user initiated the mechanism.

4.2.1.1.2 Multilingual network name descriptor

This descriptor may be used to convey the name of the network in one or more languages. This descriptor is optional, but when present shall only be included once in the first descriptor loop of the NIT.

4.2.1.1.3 Network name descriptor

This descriptor is used to transmit the name of a physical network, e.g. "ASTRA", "EUTELSAT", "MUNICH CABLE" etc. This descriptor shall be used exactly once in the first descriptor loop of any NIT sub-table.

4.2.1.1.4 Cell list descriptor

This descriptor is only allowed in a Network Information Table (NIT) that describes a terrestrial network. It is used to list the cells of a network.

TPS bits (ETSI EN 300 744 [i.6]) may be used to identify a cell. If this cell identification mechanism is used to support hand-over, this descriptor shall be present. Otherwise, the transmission of this descriptor is optional. If it is present, the cell list shall be complete. The descriptor is allowed more than once in the first descriptor loop of the NIT.

The latitude and longitude indicate the south-western corner of the spherical rectangle that approximately describes the coverage area of the cell. They do not indicate the position of the transmitter.

4.2.1.1.5 Network change notify descriptor

This descriptor allows broadcasters to signal network change events to receivers. A network change event is a single, clearly identifiable change in the network configuration, e.g. transmission parameters and/or available services, which may require action on the part of receivers.

Inclusion of this descriptor is optional. If it is used, it is allowed more than once in the first descriptor loop of the NIT.

Where the network_change_notify descriptor is used, the following rules shall apply:

- a) each period of engineering works shall be signalled separately and the duration of each shall be kept to a minimum;
- b) network changes should be signalled at least one week in advance and continue to be signalled for at least one month afterwards;
- c) the descriptor shall signal at all times the current list of scheduled network change events;
- d) absence of the descriptor shall be used to indicate that there are no scheduled network change events;
- e) broadcasters should make sure that all network changes have been completed by the end of the signalled period since receivers may start scanning immediately after the end of the signalled period.

Network changes may be confined to a part of the network, as indicated by the use of the cell_id field (used in DVB-T and DVB-T2 systems) or may apply to the whole network, as defined by the NIT. Different network change periods affecting the same part of the network shall not overlap.

Receivers should not rely on a steady network state during the signalled change period.

4.2.1.1.6 URI linkage descriptor

This descriptor is used to give a link to a resource which is available via an IP network. If it appears in the first descriptor loop of the NIT it links to a resource that is attached to the network operator. This descriptor is allowed more than once in the first descriptor loop of the NIT. Transmission of this descriptor is optional. The meaning of the descriptor when it occurs in the first descriptor loop of the NIT depends on the value of the uri_linkage_type. If in that case the uri_linkage_type is:

- a) 0x00, it refers to an Online SDT resource as defined by CI Plus [i.21]. This resource will provide a list of IP based services that may be offered to the viewer;
- b) 0x01, it refers to a Service Discovery and Selection (SD&S) resource as defined by DVB-IPTV [i.22].
- c) 0x02, it refers to a Material Resolution Server (MRS) resource as defined by ETSI TS 103 286-2 [i.23]. In this case, additional rules defined in ETSI TS 103 286-2 [i.23] will apply.

NOTE: A URI linkage descriptor using uri_linkage_type 0x02 may also occur in other locations. See clause 4.2.7.6 for details.

The meaning of other values of uri_linkage_type is not defined in this context.

4.2.1.2 Second descriptor loop

4.2.1.2.1 Delivery system descriptors

The delivery system descriptors are defined in clauses 6.2.13 and 6.4.6 of ETSI EN 300 468 [1]. The delivery system descriptors are used to transmit the physical parameters for each DVB stream in the network.

The general rule is that only one delivery descriptor shall appear in each transport descriptor loop (second descriptor loop) of a NIT, but there are the following exceptions to this general rule:

- More than one C2 bundle delivery system descriptors may be present in a transport descriptor loop of a NIT.
- More than one T2 delivery system descriptor may be present in a transport descriptor loop of a NIT.
- An S2 satellite delivery system descriptor may only be present in addition to a satellite delivery system descriptor, and if the S2 mode in use cannot be described by a satellite delivery system descriptor alone (e.g. such as when the default scrambling sequence is not used or multiple input streams are present).

NOTE: If the S2 mode in use can be fully described by a satellite delivery system descriptor alone, then only the satellite delivery system descriptor is required in the transport descriptor loop (second descriptor loop) of a NIT.

- More than one S2Xv2 delivery system descriptor may be present in a transport descriptor loop of a NIT representing a transponder using channel bonding. One S2Xv2_satellite_delivery_system_descriptor describes the master channel and one or two S2Xv2_satellite_delivery_system_descriptor(s) describes the secondary channel(s).

IRDs shall be able to interpret the delivery system descriptor in order to tune to TSs quickly (see clauses 4.1.1 and 5.3.1).

4.2.1.2.2 Service list descriptor

This descriptor is used to list the services and their types for each TS. The services are listed identified by service_id (= MPEG-2 program_number). The transport_stream_id and original_network_id, which are necessary to identify an instance of a DVB service uniquely, are given at the start of the second descriptor loop of the NIT. The type of the services is identified by the service_type field to allow the service provider to describe the nature of the service, e.g. broadcast television, on-demand television, broadcast radio, data broadcast. This field is also present in the service descriptor, which shall be present in the SDT (see clause 4.2.3.10). Further rules on assignment and interpretation of the service_type field are given in annex I of ETSI EN 300 468 [1].

The service list descriptor is allowed only once in each second descriptor loop of the NIT. Transmission of this descriptor is optional. When present, it should list all services.

NOTE: When a service is not listed in the service descriptor in the SDT, the service list descriptor can still be used to indicate the service type.

4.2.1.2.3 Frequency list descriptor

This descriptor lists the additional frequencies used in transmission of a multiplex on other frequencies.

The frequency_list descriptor is allowed only once in each second descriptor loop for which there is a delivery system descriptor. Inclusion of this descriptor is optional, but if it is present, then the list of frequencies shall be complete.

4.2.1.2.4 Cell frequency link descriptor

This descriptor is only allowed in a Network Information Table (NIT) that describes a terrestrial network. It is used to provide links between a cell and the frequencies that are used in this cell for the transport stream described.

TPS bits (ETSI EN 300 744 [i.6]) may be used to identify a cell. If this cell identification mechanism is used to support hand-over, this descriptor shall be present. Otherwise, the transmission of this descriptor is optional. If it is present, the cell list shall be complete. The descriptor is allowed more than once in each second descriptor loop of the NIT.

4.2.2 Descriptors of the Bouquet Association Table (BAT)

4.2.2.0 BAT structure

The BAT is organized as follows:

```

/* header ...*/
for (i = 0; i < N; i++) { /* 1st descriptor loop */
    descriptor()
}
for (i = 0; i < N; i++) {
    /* loop over transport streams */
    transport_stream_id
    original_network_id
    for (j = 0; j < M; j++) { /* 2nd descriptor loop */
        descriptor()
    }
}
/* CRC etc. */

```

The BAT has the same structure as the NIT. The BAT gives a logical grouping of services into bouquets, which may group together services delivered by different networks. A TS may contain services from more than one bouquet within a network. Each BAT collects the services that are allocated to the specified bouquet.

4.2.2.1 First descriptor loop

4.2.2.1.1 Bouquet name descriptor

This descriptor is used to transmit the name of the bouquet the following services are allocated to, e.g. "THE NEWS BOUQUET", "HEAVEN MOVIE CHANNELS" etc. This descriptor is allowed once in the first descriptor loop of each sub-table of the BAT. It is mandatory to be transmitted in the first descriptor loop of any BAT sub-table in the TS.

4.2.2.1.2 CA identifier descriptor

Transmission of this descriptor is optional; it is allowed only once in the first descriptor loop of the BAT. It identifies one or more CA systems which apply to the services in the BAT.

4.2.2.1.3 Country availability descriptor

This descriptor is used to indicate whether a bouquet is available in a specific country. It has no meaning in the sense of CA.

NOTE: IRDs can use this descriptor to only display bouquets that are available in order to avoid confusion of the viewer.

This descriptor is allowed at most twice in the first descriptor loop of each BAT sub-table; at most once to indicate a list of countries in which the bouquet is intended to be available, and at most once to indicate those countries in which it is not intended to be available. If the descriptor is not present, the availability status of the bouquet is undefined. Transmission of this descriptor is optional.

4.2.2.1.4 Linkage descriptor

This descriptor is used to give a link to a service or TS. If it appears in the first descriptor loop of the BAT, it links to a service that is attached to the bouquet provider. For example it could point to the "Heaven movie teasers" and to "Heaven text TV". The linkage_descriptor is allowed more than once in the first descriptor loop of the BAT. Transmission of this descriptor is optional. The meaning of the descriptor when it occurs in the first descriptor loop of the BAT depends on the value of the linkage_type. If the linkage_type is:

- a) 0x01, the descriptor refers to a service that contains information about the bouquet. An example of the intended use is for the IRD to switch to the information service when the user requests additional information about the bouquet;
- b) 0x02, the descriptor refers to an Electronic Program Guide (EPG) for the bouquet;

NOTE: The IRD can only make use of this type of linkage if it can decode the EPG service. The present document does not specify the contents of such a service.

- c) 0x04, it refers to a transport stream which carries comprehensive Service Information. The SI carried in the referenced transport stream includes at least all the SI information available on all other TSs which carry services of the bouquet;
- d) 0x09, it refers to a transport stream carrying a System Software Update service, see ETSI TS 102 006 [i.15];
- e) 0x0A, it refers to a transport stream carrying a System Software Update BAT or NIT with detailed signalling information about System Software Update services, see ETSI TS 102 006 [i.15].

The meaning of other values of linkage_type is not defined in this context. Note that the linkage_type does not indicate the service_type of the referenced service. An example of the intended use of the linkage descriptor is that an IRD user interface could include a mechanism like "info about the bouquet" which would make the IRD tune to the linked service after the user initiated the mechanism.

4.2.2.1.5 Multilingual bouquet name descriptor

This descriptor may be used to convey the name of the bouquet in one or more languages. This descriptor is optional, but when present shall only be included once in the first descriptor loop of the BAT. Transmission of this descriptor is optional.

4.2.2.2 Second descriptor loop

4.2.2.2.1 Service list descriptor

This descriptor is used to list the service_id and the service_type of the services on a TS that belong to the bouquet of this BAT sub-table.

The service_type field allows the service provider to describe the nature of each service, e.g. broadcast television, on-demand television, broadcast radio, data broadcast. This field is also present in the service descriptor, which shall be present in the SDT (see clause 4.2.3.10). Further rules on assignment and interpretation of the service_type field are given in annex I of ETSI EN 300 468 [1].

This descriptor is optional, but when present shall only be included once in the second descriptor loop of the BAT. It should be transmitted since it allows the IRD to find all services that belong to a specific bouquet.

NOTE: This implies that the use of this descriptor in the BAT need not list all the services in this transport stream.

4.2.3 Descriptors of the Service Description Table (SDT)

4.2.3.0 SDT structure

The SDT is organized as follows:

```
table_id      /* distinction between actual & foreign MUXes */
/* header ....*/
transport_stream_id
original_network_id
for (i = 0; i < N; i++) { /* descriptor loop */
    service_id
    EIT_schedule_flag
    EIT_present_following_flag
    running_status
    free_CA_mode
    for (j = 0; j < M; j++){
        descriptor()
    }
}
/* CRC etc. */
```

The SDT has a loop for descriptors for each service described in the SDT.

4.2.3.1 Announcement support descriptor

The announcement support descriptor informs about announcements supported by the service. It is an optional descriptor and allowed only once in each SDT service loop.

4.2.3.2 CA identifier descriptor

If a service is generally CA-protected, this descriptor may be used to transmit data of the CA-system. The CA_identifier_descriptor is not involved in any CA control function, it is an indication for the user interface software in the IRD that a service is under conditional access, and which CA-system is used. Then the user interface software may decide whether this service is reachable or not. The aim of the transmission of this descriptor is to avoid frustration to users caused by services being displayed for selection that are not reachable.

This descriptor is allowed only once in the SDT service loop. It is not allowed if there is a time_shifted_service_descriptor. Transmission of this descriptor is optional in the SDT.

4.2.3.3 Component descriptor

This descriptor is used to specify streams that are part of a DVB service. When present in the SDT, this can be used by the IRD to control the presentation of the service to the viewer.

When present in the SDT, the component_descriptor defines a default stream specification that is inherited by all events forming part of this service.

NOTE: Any such default stream specification may be overridden on an event by event basis by the use of the component_descriptor in the EIT (see clause 4.2.4.2).

This descriptor shall not be used if a time_shifted_service_descriptor is present in the SDT.

Generally, transmission of this descriptor is optional, except for the HEVC service types using HD and UHD as defined in annex I.2.5 and I.2.6 of ETSI EN 300 468 [1]. Except for these HEVC service types, no mandatory requirements regarding which (if any) streams are specified within the SDT by use of a component_descriptor are implied.

The descriptor may appear more than once in an SDT service loop since there may be more than one stream being specified, and since more than one descriptor may be needed to describe a stream.

4.2.3.4 Country availability descriptor

This descriptor is used to indicate whether a service is available in the specified country. It has no meaning in the sense of CA.

NOTE: IRDs can use this descriptor to only display services that are available in order to avoid confusion of the viewer.

This descriptor is allowed at most twice in each SDT service loop, at most once to indicate a list of countries in which the service is intended to be available, and at most once to indicate those countries in which it is not intended to be available. If the descriptor is not present, the availability status of the service is undefined.

It is not allowed if there is a time_shifted_service_descriptor. Transmission of this descriptor is optional.

4.2.3.5 Data_broadcast_descriptor

See clause 4.2.7.3.

4.2.3.6 Linkage descriptor

This descriptor is used to give a link to a service. If it appears in the SDT service loop, it links to a service that is related to this service. Transmission of this descriptor is optional. More than one linkage descriptor is allowed in a loop. The meaning of the descriptor, when it occurs in the SDT service loop, depends on the value of the linkage_type. If the linkage_type is:

- a) 0x01, the descriptor refers to a service that contains information about this service. An example of the intended use is for the IRD to switch to the information service when the user requests additional information about this service;
- b) 0x02, the descriptor refers to an Electronic Program Guide (EPG) for this service;

NOTE 1: The IRD can only make use of this type of linkage if it can decode the EPG service. The present document does not specify the contents of such a service.

- c) 0x03, the descriptor refers to a CA replacement service for this service. An example of the intended use is for the IRD to switch automatically to the replacement service if the CA system denies access to this service;
- d) 0x05, the descriptor refers to a replacement service for this service. An example of the intended use is for the IRD to switch automatically to this replacement service when the selected service has a running status of "not running";

NOTE 2: The linkage_type does not indicate the service_type of the referenced service.

An example of the intended use of the linkage descriptor is that an IRD user interface could include a mechanism like "info about the service", which would make the IRD tune to the linked service after the user initiated the mechanism.

- e) 0x08, it refers to a service in a terrestrial network to which the receiver might tune to if the actual service is no longer receivable under its service_id. The hand-over_type indicates whether the linkage_descriptor is used to link to an identical service in a neighbouring country, to a local variation of the service or an associated service.

4.2.3.7 Mosaic descriptor

This descriptor may be located in the SDT service loop, and/or the PMT. It is used to describe mosaic services as described in clause 5.2. It is not allowed if there is a time_shifted_service_descriptor.

4.2.3.8 Multilingual service name descriptor

This descriptor may be used to convey the name of the service provider and service name in one or more languages. It is allowed only once in the SDT service loop. Inclusion of this descriptor is optional.

4.2.3.9 NVOD reference descriptor

This descriptor lists the services which belong to a Near Video On Demand (NVOD) service. A description of the NVOD-mechanisms is given in clause 5.1.

The NVOD_reference_descriptor is allowed only once in each SDT service loop. It is mandatory to be transmitted if the corresponding services are described using the time_shifted_service_descriptor.

IRDs are recommended to make use of the NVOD_reference_descriptor in order to allow access to NVOD-services.

4.2.3.10 Service descriptor

This descriptor contains the basic textual identifications of a service such as service name and provider name. It also conveys the service_type field to allow the service provider to describe the nature of the service, e.g. broadcast television, on-demand television, broadcast radio, data broadcast. This field is also present in the service list descriptor, which may be present in the NIT (see clause 4.2.1.2.2) or BAT (see clause 4.2.2.2.1). Further rules on assignment and interpretation of the service_type field are given in annex I of ETSI EN 300 468 [1].

It is mandatory to be transmitted unless a time_shifted_service_descriptor is present, in which case the service descriptor shall not be used. If the service descriptor is present, it shall only be allowed once in each SDT service loop.

IRDs are recommended to make use of it in order to display the service names in the user interface.

4.2.3.11 Service availability descriptor

4.2.3.11.0 General rules

This descriptor is used in the SDT to provide a link between a service in a terrestrial network and the network cells in which it is available or unavailable. Transmission of this descriptor is optional. The descriptor is allowed more than once in the SDT service loop.

This descriptor may be used in terrestrial networks for local services which are not present on the whole network. In this case the association between the multiplex and the cell on which it is broadcast is made by the insertion of the cell_id in the TPS bits of the radiated multiplex. By extracting this information from the TPS bits, and using the descriptor in the SI, the receiver is able to build a service list containing only the relevant services available in the cells it is currently able to receive. The mechanism prevents the user from being presented services which are in fact not receivable at his/her current location.

In a specific multiplex/cell_id combination, the components of all services indicated to be available in the SDT actual shall be available in the multiplex, if the service is running.

The services in the SDT actual, matching the cell_id in one of the service availability descriptors, shall describe all services available in the multiplex.

The SDT actual should describe all services occurring in all multiplexes of a network that match its transport_stream_id and its original_network_id. The SDT shall not contain multiple instances of the same combination of service_id and original_network_id in a sub_table. However, for DVB-SH and DVB-H, the SDT sub_table sections may contain multiple instances of the same combination of service_id and original_network_id (see clause 4.1.11.2.3).

NOTE 1: The cell_id cannot be used to identify a service. The combination of service_id and original_network_id remains a unique identification of a service.

NOTE 2: Due to the wording in previous versions of the present document, the uniqueness of a service was not well defined. This led to receiver implementations with different interpretations of the uniqueness of a service. Some receivers thus assume that a service_id may only occur in a single multiplex. Therefore broadcasters with a population of such receivers should take care when assigning service_id values to ensure that only a single instance of any service_id is visible to those receivers.

It is not the intention to describe multiplexes that are only distinguished by service_availability separately in the NIT and BAT. Therefore, in the second loop of the NIT and BAT there shall be at most one association between original_network_id, transport_stream_id and the frequency_list_descriptor. The same shall apply for service_list_descriptor.

NOTE 3: Both frequency_list_descriptor and service_list_descriptor remain optional when local service availability is used in a network.

Mixed use of service_availability qualification of services in a network or even in a multiplex is possible. A service not linked to a particular service_availability_descriptor shall be considered available in all cells transmitting the multiplex.

4.2.3.11.1 Network Implementation Considerations

By using the service_availability_descriptor, network operators can create one SI for multiple multiplexes in a network, yet still define specific subsets of these services to be valid for the different transmitters in a network (i.e. this creates one large "virtual" transport stream of which only the relevant parts are transmitted on each transmitter). A typical example purpose for this are local variations of one "mother" service carried in a transport stream. The SI may for example be the same for a set of multiplexes, but each of these multiplexes may carry a different set of services and indicate (through the association between cell_id and service_availability descriptor) which of the services are actually carried in a specific instance of the multiplex. The only differentiation between these multiplexes is made in the receiver through the link with the cell_id. It is also clear that the PSI information of different multiplexes should be consistent (as normal) and should not contain PSI for services that are not available. I.e. the network operator may use a central SI generator but should (re)multiplex the multiplexes at the PSI and ES level.

When defining terrestrial networks and local variations on these networks, the number of network cells and the association between the cells and the services have to be carefully defined in order to control the amount of SI information in the multiplex because the SDT and EIT carried in all multiplexes will grow as the common SI has to carry more service instances.

The network operator should be aware that resolution of linkage_descriptor information and other references to transport streams only via transport_stream_id may no longer be uniquely possible by an IRD. So in case such a reference is made, the specific resolution to multiplex **shall** be arbitrary. Note that resolution to a service carried in a specific multiplex from the service_id should still be uniquely possible (if the multiplex(es) carrying it can be received by the IRD).

4.2.3.11.2 IRD implementation considerations

The recommendations below should be followed to allow optimal functionality in networks deploying service_availability_descriptors:

- It is recommended to match SDT and EIT information (depending on the purpose of use) either with:
 - Cell_id of current multiplex (for deriving information on the currently tuned multiplex).

- Cell_ids of all receivable instances of a multiplex (for deriving information on all receivable services including cross-carriage information for multiplexes with the same transport_stream_id).
- No matching on cell_id for generating the most abundantly available SI information.
- It is recommended to make all receivable multiplexes with the same transport_stream_id but with different cell_ids available to the user, and only when a service (not a transport stream) is available through multiple multiplexes to select a preferred multiplex based on e.g. reception quality.

Any reference resolution from a transport_stream_id or a service_id (e.g. from a linkage_descriptor transport_stream_id/service_id pair) to a multiplex/frequency requires consideration to handle the potential multiplicity of the result.

Note that in networks deploying the service_availability_descriptor, the unique identification of a transport stream by the tuple (transport_stream_id, original_network_id), can often be sensibly replaced by identification through the triplet (transport_stream_id, original_network_id, cell_id).

4.2.3.12 Service relocated descriptor

This descriptor provides a mechanism which enables an IRD to track a service which has moved from one TS to another, or has changed service identifiers.

If the service remains within the same original network, then the new_service_id should be the same as the previous service_id where possible (see clause 4.1.1).

If a complete TS is moved, then this can be achieved by updating the NIT tuning information for the TS. In this case the original_network_id, transport_stream_id, and service_ids are unchanged, and the service_relocated_descriptor is not applicable.

Transmission of this descriptor is optional. The descriptor may appear more than once in an SDT service loop.

The following rules are recommended to minimize the discontinuity:

- a) Before a service moves, the network change notify descriptor (see clause 4.2.1.1.5) should be used to give receivers advance notice of a change.
- b) During the change, the service should be available at the old and new locations, where possible. In this case, to make receivers aware of the service's new location, a service move descriptor (see clause 4.2.6.10) should be added to the old services PMT and service relocated descriptors should be added to the SDT on the new services.
- c) After the change is completed, the service relocated descriptor should be present for some time to indicate the old location and assist receivers which have not acquired the service during the changeover period.

4.2.3.13 Telephone descriptor

Transmission of this descriptor is optional, and it may occur more than once in the SDT service loop. It is not allowed if there is a time_shifted_service_descriptor.

IRDs cannot make use of it without further information ([i.17], [i.18] and [i.19]).

4.2.3.14 Time shifted service descriptor

This descriptor identifies a service as a time shifted copy of another service (clause 5.1).

The time_shifted_service_descriptor is allowed only once in each SDT service loop. It is mandatory to be transmitted for services listed in an NVOD_reference_descriptor.

If a time_shifted_service_descriptor is present in an SDT service loop, the following descriptors are not allowed in the same descriptor loop:

- multilingual_service_name_descriptor;
- CA_identifier_descriptor;
- country_availability_descriptor;

- mosaic_descriptor;
- telephone_descriptor;
- service_descriptor.

IRDs are recommended to be able to interpret it in order to access NVOD-events.

4.2.4 Descriptors of the Event Information Table (EIT)

4.2.4.0 EIT structure

An EIT-section is organized as follows:

```
table_id      /* classification of the EI-section : present following etc. */
/* header ....*/
service_id
transport_stream_id
original_network_id
for (i = 0; i < N; i++) { /* descriptor loop */
    event_id
    start_time
    duration
    running_status
    free_CA_mode
    for (j = 0; j < M; j++){
        descriptor()
    }
}
/* CRC etc. */
```

The EIT has a loop for descriptors for each event described in the EIT.

4.2.4.1 CA identifier descriptor

If an event is CA-protected, this descriptor may be used to transmit data of the CA-system. The CA_identifier_descriptor is not involved in any CA control function, it is an indication for the user interface software in the IRD that the event is under conditional access and which CA-system is used. Then the user interface software may decide whether this service is reachable or not. The aim of the transmission of this descriptor is to avoid frustration to users caused by events being displayed for selection that are not reachable.

This descriptor is allowed only once in the EIT event loop. It is not allowed if there is a time_shifted_event_descriptor. Transmission of this descriptor is optional in the EIT.

4.2.4.2 Component descriptor

This descriptor is used to specify streams that are part of a DVB event.

The descriptor may appear more than once in the EIT event loop since there may be more than one stream, and since more than one descriptor may be needed to describe a stream.

If there is a time_shifted_event_descriptor, this descriptor is not allowed. Transmission of this descriptor in the EIT Present/Following for the actual TS is mandatory for all elementary streams except those:

- whose specification can be inherited from use of the component_descriptor in the relevant SDT; or
- which are present but are not used during the current event; or

NOTE: A broadcaster may choose not to remove an elementary stream from the PMT during events where this elementary stream is not used. The presence of the component descriptor in the EIT indicates whether the elementary stream is in use during the event.

- which are only suitable for presentation by an accompanying (e.g. MHP) application; or
- which are coded according to the data broadcasting specification, for which the data broadcasting descriptor may be used.

Transmission of this descriptor is optional for EIT schedule (actual and other) and for EIT present/following other. It is useful to indicate which streams will be available for future events.

The stream specification provided by an instance of this descriptor in EIT shall override any default stream specification for the same component (as identified by `component_tag`) defined in the SDT (see clause 4.2.3.3).

4.2.4.3 Content descriptor

This descriptor is used to classify the content of the event. Only one content descriptor may appear in the EIT event loop. It is possible to transmit more than one classification term because there is a loop within the descriptor.

If there is a `time_shifted_event_descriptor`, this descriptor is not allowed, since the content information can be provided in the EIT sub-table for the corresponding NVOB reference service. Transmission of this descriptor is optional.

4.2.4.4 Data_broadcast_descriptor

See clause 4.2.7.3.

4.2.4.5 Extended event descriptor

This descriptor is used to transmit a bigger amount of textual information for an event than is possible with the `short_event_descriptor`. The information in extended event descriptors supplements that given in a short event descriptor. A language code is transmitted in order to indicate in which language the text is written. More than one `extended_event_descriptor` is allowed in the EIT event loop, for transmitting more data than one descriptor can contain (255 bytes excluding header), and for different languages. The `last_descriptor` field specifies the number of the last `extended_event_descriptor` for a specific language.

If there is a `time_shifted_event_descriptor`, this descriptor is not allowed. Transmission of this descriptor is optional.

4.2.4.6 Linkage descriptor

This descriptor is used to give a link to an event or service. If it appears in The EIT event loop, it links to an event or a service that is attached to this event. Transmission of this descriptor is optional. More than one linkage descriptor is allowed in an EIT event loop. The meaning of the descriptor, when it occurs in the EIT event loop, depends on the value of the `linkage_type`. If the `linkage_type` is:

- 0x01, the descriptor refers to a service that contains information about this event. An example of the intended use is for the IRD to switch to the information service when the user requests additional information about this event. If there is a `time_shifted_event_descriptor`, this `linkage_type` is not allowed.

An example of the intended use of this `linkage_type` is that an IRD user interface could include a mechanism like "info about the event" which would make the IRD tune to the linked service after the user initiated the mechanism.

- 0x0D, the descriptor is used to link from the current event (assumed to be an SD event) to an HD version of the same content. They may be scheduled at the same or at different times.

When the SD and HD events are scheduled to start at the same time, the `event_simulcast` field should be set to 1. In all other cases the field should be set to 0.

In order for sequential HD simulcast events to be displayed by a receiver without channel change interruption, the service operator should cross-carry the EIT of the original service in the multiplex of the target service. This allows the receiver to always track the next event on the original service and detect a subsequent `HD_simulcast_event` link.

Receivers are recommended to implement a user confirmation when switching back and forth to the HD simulcast event, and take into account the reception quality of the service carrying the HD event.

In case of `target_listed = 0`, the receiver should use the service identification (i.e. `service_name`) of the original service, when appropriate, while displaying the target service.

- In the range 0x0E to 0x1F, the descriptor is used to link from the current event to one or more alternative instances of the same content, but which differ in encoding characteristics. They may be scheduled at the same or at different times.

These linkage types are similar to the linkage type 0x0D described above, but provide a more versatile way of linking alternative instances. They are not limited to linking SD and HD video only, but allow for a wider variety of content formats, and they allow to link from one source event to several target events, which may differ in content format.

For the use of these linkage_type values, the rules defined in annex K of ETSI EN 300 468 [1] shall apply.

The meaning of other values of linkage_type is not defined in this context. Note that the linkage_type does not indicate the service_type of the referenced service.

4.2.4.7 Multilingual component descriptor

This descriptor may be used to convey text describing a component of an event in one or more languages. This descriptor is optional, but when present shall only be included once in the EIT event loop for each component of an event. If there is a time_shifted_event_descriptor, then this descriptor is not allowed.

4.2.4.8 Parental rating descriptor

This descriptor is used to give a rating of the programme based on age or other criteria that is used to prevent children from viewing unsuitable programmes. If there is a time_shifted_event_descriptor, this descriptor is not allowed, since the parental rating information can be provided in the EIT sub-table for the corresponding NVOD reference service. This descriptor is optional, but when present shall only be included once in the EIT event loop

Country_codes relating to groups of countries may be used within the descriptor. If, as a result, there is more than one entry for a country in the descriptor, then the first entry in the descriptor which includes the country shall take precedence over any subsequent entry. For example, the following sequence of data within the descriptor would describe a parental rating of minimum age of 12 in all countries except UK, for which the minimum age is 18.

EXAMPLE: country_code = UK
 rating = 0x0F
 country_code = all countries
 rating = 0x09

4.2.4.9 PDC descriptor

The PDC_descriptor extends the DVB system with the functionalities of PDC (ETSI EN 300 231 [i.10]). The descriptor carries the Programme Identification Label (PIL) as defined in ETSI EN 300 231 [i.10]. This label has, in principle, the same function as the DVB event_id, but with the advantage of being available to the public implicitly by many media a long time in advance.

The PIL contains date and time of the first published start time of a certain event. Within analogue systems the PIL is either broadcast in the teletext format or as a part of the VPS label in dataline 16. No change is made to the PIL once it has been made publicly available provided the transmission time remains within the validity time window (ETSI EN 300 231 [i.10]).

No use shall be made of types of "service codes" (ETSI EN 300 231 [i.10]) which would imply dynamic changes during a running event. Their function shall only be covered by the RST.

If a service supports the PDC function, a PDC descriptor shall appear once in all EIT present/following sub_tables for the actual TS of the service.

4.2.4.10 Short event descriptor

This descriptor is used to transmit the name and a short text description for an event. A language code is transmitted in order to indicate in which language the title and the text are written. Transmission of this descriptor is mandatory, unless there is a time_shifted_event_descriptor, in which case the descriptor is not allowed. This descriptor is allowed more than once in the EIT event loop for different languages. Thus it is not allowed to have more than one short_event_descriptor with the same language code.

4.2.4.11 Telephone descriptor

Transmission of this descriptor is optional, and it may occur more than once in the EIT event loop. IRDs cannot make use of it without further information [i.17].

4.2.4.12 Time shifted event descriptor

This descriptor is used to indicate that an event is the time-shifted copy of another event. If this descriptor is present only a PDC_descriptor, private_data_specifier_descriptors and private descriptors are allowed in the EIT event loop.

Transmission of this descriptor is mandatory in case of NVOD. IRDs are recommended to decode this descriptor, without which access to the Service Information of NVOD events is not possible.

4.2.5 Descriptors of the Time Offset Table (TOT)

4.2.5.0 TOT structure

The TOT is organized as follows:

```
/* header ....*/
UTC_time
for (i = 0; i < N; i++) { /* descriptor loop */
    descriptor()
}
/* CRC etc. */
```

4.2.5.1 Local time offset descriptor

This descriptor may be used to indicate the local time offset and the automatic adjustment between summer and winter time by an IRD. Broadcasters should ensure that time_of_change is valid in that it should represent the time of the last daylight savings change or that of the next forthcoming daylight savings change. Time_of_change should be updated to carry a forthcoming daylight savings change with as much notice as possible. This should be at least equal to the time scope of any associated EIT schedule to ensure a correct presentation of the programme schedule to the user across the change.

The data given in the descriptor will be constant for most of the time, but will be updated by the broadcaster to announce the transitions from summer time to winter time and vice versa in advance. In the TOT descriptor loop the local time offset descriptor may occur more than once. It is assumed that the same set of countries/country regions be included in the TOT at all times. Only one time_of_change should be signalled for each combination of country_code and country_region_id.

If the time of the next change is unknown, or there is no next change (in the case of a region that does not use daylight saving) then the time_of_change field shall contain a valid value and the next_time_offset field shall convey the same value as the local_time_offset field.

If a country uses more than one time zone, the country_region_id field identifies the different regions of the country with different time zones.

Example data for the descriptor fields:

country_code:	x9yy (European Continent countries group)
country_region_id	000000
local_time_offset_polarity	0
local_time_offset	0000000100000000 (Winter: 1 hour)
	0000001000000000 (Summer: 2 hours)

The descriptor may be applied in the following applications:

- display of the current local time on the IRD or TV screen;
- display of the programme guide in local time;
- timer programming of the video recorder in local time.

4.2.6 Descriptors of the Program Map Table (PMT)

4.2.6.0 PMT structure

The PMT is organized as follows:

```

/* header ....*/
program_number /* service_id */
PCR_PID
for (i=0; i<N; i++) { /* program_info loop */
    descriptor()
}
for (i=0; i<N; i++) {
    /* loop over elementary streams */
    stream_type
    elementary_PID
    for (i=0; i<N; i++) { /* ES_info loop */
        descriptor()
    }
}
/* CRC etc. */

```

In addition to the descriptors defined in ISO/IEC 13818-1 [2] the following DVB SI descriptors may be used in the PMT.

4.2.6.1 AC-3 descriptor

For guidelines on the inclusion and use of the AC-3 descriptor please refer to annex D of ETSI EN 300 468 [1].

4.2.6.2 Adaptation field data descriptor

The adaptation field data descriptor provides a means of indicating the type of data fields supported within the private data field of the adaptation field coded according to ISO/IEC 13818-1 [2]. It shall be inserted into the corresponding ES_info loop of the PMT if the stream contains one or more of the data fields listed in table 14 of ETSI EN 300 468 [1].

4.2.6.3 Ancillary data descriptor

This descriptor is used to indicate the presence and type of ancillary data in the audio elementary streams coded according to ISO/IEC 13818-3 [i.11] and ISO/IEC 11172-3 [i.12]. If the ancillary data adheres to one of the formats in table 16 of ETSI EN 300 468 [1], this descriptor shall be inserted once into the corresponding ES_info loop of the PMT. It is recommended that the IRD uses this information to indicate the presence and type of ancillary data to the audio decoder.

The presence of the extended ancillary data field (ETSI TS 101 154 [i.7], annex D) does imply the presence but not the validity of the DVD-Video ancillary data field. Thus:

- $b_0 == 1$ && $b_1 == 0$ means that the DVD-Video ancillary data field is present and valid.
- $b_0 == 0$ && $b_1 == 1$ means that firstly the extended ancillary data field is present and valid and secondly that the DVD-Video ancillary data field is present but not necessarily valid. In this case the receiver should use the extended version of the dynamic range control data, because it results in better quality.
- $b_0 == 1$ && $b_1 == 1$ means that both the DVD-Video ancillary data field and the extended ancillary data field are present and valid.

4.2.6.4 Audio preselection descriptor

This descriptor may be present at most once in each ES info loop of a PMT describing an audio elementary stream. For guidelines on the inclusion and use of the audio preselection descriptor please refer to the following clauses of ETSI EN 300 468 [1], clause 6.4.1, and annex M.

Coexistence of this descriptor with the supplementary audio descriptor (see also clause 4.2.6.13) and the ISO_639_language_descriptor (which is defined by ISO/IEC 13818-1 [2]) is defined in clause M.2 of ETSI EN 300 468 [1].

4.2.6.5 Data broadcast id descriptor

This descriptor is a short form of the data_broadcast descriptor and it may be placed more than once in an ES_info loop of a PSI PMT table. Within this descriptor there is a field called data_broadcast_id, identifying the type of data service within the multiplex. The allocation of the values is given in ETSI TS 101 162 [i.2].

Values 0x0001 to 0x00EF of the data_broadcast_id (see ETSI TS 101 162 [i.2]) are specified in ETSI EN 301 192 [i.3]. Guidelines for the use of ETSI EN 301 192 [i.3] are given in ETSI TR 101 202 [i.4].

There may only be at most one instance with a data_broadcast_id value in the range 0x0000 to 0x007F. Additional instances from the range 0x0080 to 0x00EF are allowed.

The range of values 0x0100 through 0xFFFFE can be used for the registration of private data broadcast systems. The DVB Services website <http://www.dvbservices.com>, which is frequently updated, gives a list of all registered data_broadcast_ids.

4.2.6.6 Enhanced AC-3 descriptor

For guidelines on the inclusion and use of the Enhanced AC-3 descriptor please refer to clauses D.4 and D.5 of ETSI EN 300 468 [1].

4.2.6.7 Mosaic descriptor

This descriptor may be located in the PMT, and/or the SDT. Its use to describe mosaic services is described in clause 5.2.

4.2.6.8 Related content descriptor

The related content descriptor identifies an elementary stream that delivers a related content table. For guidelines on the inclusion and use of this descriptor please refer to ETSI TS 102 323 [i.24].

4.2.6.9 Scrambling descriptor

This descriptor may be located in the program loop of the PMT, in which case it indicates the scrambling mode of operation used for any scrambled elementary stream of the service. It shall occur at most once in the program loop of a PMT. For further guidelines on the use of the scrambling descriptor please refer to annex E of ETSI EN 300 468 [1].

Whether an elementary stream is scrambled or not, can be inferred from the TS packet header. The free_CA_mode conveyed in the SDT and EIT may also provide information as to whether a service should be expected to currently contain one or more scrambled elementary streams.

4.2.6.10 Service move descriptor

This descriptor provides a mechanism which enables an IRD to track a service which moves from one TS to another. Note that some disturbance to the decoded video and audio will occur at such a transition. The following rules are recommended to minimize the discontinuity:

- a) in the PMT of the service which is to move, a service_move_descriptor is inserted, no earlier than the time that the service commences on the new TS and at least as long as the service continues to exist on the old TS;
- b) the service should be described in the PAT and PMT of the new stream at least from the time that the service_move_descriptor is inserted in the old TS;
- c) if the service remains within the same original network, then the new_service_id should be the same as the previous service_id where possible (see clause 4.1.1).

If a complete TS is moved, then this can be achieved by updating the NIT tuning information for the TS. In this case the original_network_id, transport_stream_id, and service_ids are unchanged, and the service_move_descriptor is not applicable.

Once the replacement service is available, a service relocated descriptor (see clause 4.2.3.12) should be added to the replacement SDT. The service relocated descriptor should be signalled for a time period after the changeover to indicate the old location and assist receivers which have not acquired the service during the changeover period.

4.2.6.11 Stream identifier descriptor

This descriptor enables specific streams to be associated with information in SI tables via the `component_tag` field. This field is for example present in the announcement support descriptor, component descriptor, data broadcast descriptor, and multilingual component descriptor.

The component descriptor and the multilingual component descriptor also provide textual descriptions of each component in the SDT or EIT. The stream identifier descriptor is mandatory if the service contains more than one stream of the same type and the only distinction between them in PSI/SI is their textual descriptions.

4.2.6.12 Subtitling descriptor

This descriptor is used to identify DVB subtitle data which is coded in accordance with ETSI EN 300 743 [i.13]. The descriptor shall be used once in the appropriate `ES_info` field for any stream containing subtitling data coded in accordance with ETSI EN 300 743 [i.13]. The descriptor allows the identification of the language and information on the content of the subtitle. The loop within the descriptor shall appear at least once.

4.2.6.13 Supplementary audio descriptor

This descriptor may be present at most once in each ES info loop of a PMT describing an audio elementary stream. For guidelines on the inclusion and use of the supplementary audio descriptor please refer to the following clauses of ETSI EN 300 468 [1], clause 6.4.11, annex J, and clause M.2.

Coexistence of this descriptor with the audio preselection descriptor (see also clause 4.2.6.4) and the `ISO_639_language_descriptor` (which is defined by ISO/IEC 13818-1 [2]) is defined in the following clauses of ETSI EN 300 468 [1], clause M.2, and clause 6.4.11 respectively.

4.2.6.14 T2-MI descriptor

This descriptor may be present at most once in each ES info loop of a PMT describing an elementary stream carrying T2-MI data according to ETSI TS 102 773 [i.26]. It is intended for use in distribution networks, and hence shall be ignored by IRDs.

4.2.6.15 Teletext descriptor

This descriptor is used to identify EBU Teletext data which is coded in accordance with ETSI EN 300 472 [i.1]. The descriptor shall be used once in the appropriate `ES_info` field for any stream containing EBU Teletext coded in accordance with ETSI EN 300 472 [i.1]. The descriptor allows the identification of the language and type of particular "reference" pages such as subtitle or index pages. The loop within the descriptor may be omitted, in which case no specific indication of language, Teletext type, or page is given (i.e. equivalent to selecting Teletext on analogue transmissions).

4.2.6.16 VBI data descriptor

The VBI data descriptor is used to signal the transmission of VBI service data intended to be used together with the decoded video as defined in ETSI EN 301 775 [i.8]. Such data may include inverted teletext, VPS, WSS and closed-captioning. Also, a generic format for transmitting luminance-only VBI data is defined to have a means of coping with other standard or non-standard VBI systems. When the `data_service_id` indicates a user defined VBI service type, the VBI data descriptor should be preceded by a private data specifier descriptor (see clause 4.2.7.1) to unambiguously identify the type of VBI service.

The VBI data descriptor should be used in the `ES_info` loop of a stream which carries VBI data as defined in ETSI EN 301 775 [i.8]. When the `VBI_data_descriptor` is used, the appropriate `ES_info_field` of the program map section describing a VBI data stream shall contain only one `VBI_data_descriptor`.

For transmission of multiple VBI data streams in one service a `VBI_data_descriptor` in each of the `ES_info` loops of the program map section is required.

4.2.6.17 VBI teletext descriptor

ETSI EN 301 775 [i.8] allows for conveying VBI data units and EBU teletext data units using the same elementary stream. Backwards compliance with ETSI EN 300 472 [i.1] is guaranteed, as the EBU teletext as specified in ETSI EN 300 472 [i.1] and VBI data as specified in ETSI EN 301 775 [i.8] can co-exist in the same service on separate streams.

The VBI_teletext_descriptor is used in case of conveying VBI data units and EBU teletext data units using the same elementary stream. This is especially useful in areas where minimization of the number of synchronized PID streams is important. For example, in primary distribution, existing head-end receivers may only be capable of receiving one stream for both VBI and teletext data.

4.2.6.18 DTS Descriptor

The use of the DTS descriptor should be limited to use in systems where there are IRDs that do not support DTS-HD. In systems where DTS-HD is fully supported, the DTS-HD descriptor should be used to announce both DTS and DTS-HD bit streams.

For guidelines on the inclusion and use of the DTS descriptor please refer to annex G of ETSI EN 300 468 [1].

4.2.6.19 DTS-HD Descriptor

The DTS-HD descriptor is used to announce DTS and DTS-HD audio streams present in the transport stream.

For guidelines on the inclusion and use of the DTS-HD descriptor please refer to annex G of ETSI EN 300 468 [1].

4.2.6.20 DTS Neural Descriptor

The DTS Neural Descriptor is used to announce audio streams with DTS Neural encoding. This descriptor will accompany the descriptor of the audio stream that contains the DTS Neural encoded audio.

For guidelines on the inclusion and use of the DTS Neural descriptor please refer to annex L of ETSI EN 300 468 [1].

4.2.6.21 AC-4 descriptor

For guidelines on the inclusion and use of the AC-4 descriptor please refer to annex D.6 and D.7 of ETSI EN 300 468 [1].

4.2.6.22 TTML subtitling descriptor

This descriptor is used to identify DVB TTML subtitle stream. The descriptor shall be used once in the appropriate ES_info field for any stream containing a DVB TTML subtitle stream which is coded in accordance with DVB BlueBook A174 [i.25]. The descriptor allows the identification of the language and the purpose of the subtitles. The descriptor also indicates the profiles of the TTML processor and which downloadable fonts are essential to present the subtitle stream. The descriptor can also provide an optional text description of the subtitle stream.

4.2.6.23 DTS-UHD descriptor

For guidelines on the inclusion and use of the DTS-UHD descriptor please refer to clause G.5 of ETSI EN 300 468 [1].

4.2.7 Other descriptors

4.2.7.1 Private data specifier descriptor

This descriptor is used to identify the source of any private descriptor or user defined field within any descriptor. If this descriptor is located within a descriptor loop of any SI or PSI Table then its specifier applies to all following descriptors in the particular descriptor loop until its end, or until another occurrence of a private_data_specifier_descriptor or private_data_indicator_descriptor [2], whichever comes first.

The scope of a private_data_specifier_descriptor in a descriptor loop does not propagate to any following descriptor loop or into any following section. Therefore, the private_data_specifier_descriptor shall be repeated in each section that contains private descriptors or private data.

The usage of the private_data_specifier_descriptor is not mandatory but recommended since it is the only means for a decoder to determine the source of a private descriptor or privately defined value and therefore its appropriate handling.

4.2.7.2 Stuffing descriptor

This descriptor is allowed in any place in the SI where descriptors are allowed. It is used to stuff tables for any reason or to disable descriptors that are not valid by replacing them (e.g. in case of re-multiplexing). An IRD shall skip over a stuffing_descriptor.

4.2.7.3 Data broadcast descriptor

This descriptor is used to identify within the SI (SDT and/or EIT) data broadcast services in the DVB framework. For service-based implementation of data broadcasting it is recommended to place the descriptor within the SDT. For an event-oriented data broadcasting service, a descriptor may also be placed within the EIT.

Within this descriptor there is a field called `data_broadcast_id`, identifying the type of data service within the multiplex. The allocation of the values is given in ETSI TS 101 162 [i.2].

Values 0x0001-0x00EF of the `data_broadcast_id` (see ETSI TS 101 162 [i.2]) are specified in ETSI EN 301 192 [i.3]. Guidelines for the use of ETSI EN 301 192 [i.3] are given in ETSI TR 101 202 [i.4].

There may only be at most one instance with a `data_broadcast_id` value in the range 0x0000 to 0x007F for a give value of `component_tag` within a service or event. Additional instances from the range 0x0080 to 0x00EF are allowed.

The range of values 0x0100 through 0xFFFFE can be used for the registration of private data broadcast systems. The DVB Services website <http://www.dvbservices.com>, which is frequently updated, gives a list of all registered `data_broadcast_ids`.

4.2.7.4 Transport stream descriptor

This descriptor, being transmitted in the TSDT (see ISO/IEC 13818-1 [2]) only, is used to indicate the compliance of a transport stream with an MPEG based system, such as DVB.

For identification of DVB transport streams the byte field of the descriptor shall contain the values 0x44, 0x56, 0x42 (ASCII: "DVB").

For identification of DSNG Streams the byte field of the descriptor shall contain the values 0x44, 0x53, 0x4E, 0x47 (ASCII: "DSNG").

4.2.7.5 Target region and target region name descriptors

4.2.7.5.1 General Description

One of the major functions of an IRD is to present a list of services to the user that reflects those services that it can receive at its geographical location taking into account the audience intended by the broadcaster of each service. Whilst the IRD can easily determine the services that it can receive, for example by doing a scan of all possible frequencies, knowing the intention of the broadcaster requires the IRD to parse the `target_region` and `target_region_name` descriptors.

The `target_region_name` descriptor allows the broadcaster to identify all of the `target_regions` an IRD may encounter in the transmissions. At the same time, the `target_region_name` descriptor allows a broadcaster to divide each country into local regions with a defined hierarchy. At the top level are primary regions which can be divided into smaller secondary regions, each of which can be further divided into tertiary regions. The definition of these regions is left to the broadcaster but this definition is shared by all services within a network or bouquet. The broadcaster may have to follow rules laid down by national or regulatory bodies. A service may be associated to multiple `target_regions`. Using well known and accepted region names like geo-political region names (provinces, cities, etc.), opens the possibility of allowing the user to intuitively select the proper region.

For example, the UK could be divided into primary regions of England, Scotland, Wales and Northern Ireland. England could be divided into secondary regions defined by its counties (Hampshire, Sussex, Surrey, etc.). Hampshire could be divided into tertiary regions defined by its major towns and cities (Southampton, Winchester, Portsmouth, etc.).

However, there is no reason why the region boundaries have to follow any topographical logic and a region could consist of non-contiguous areas.

Using these region definitions, the broadcaster can identify which services are intended for which regions by signalling with the `target_region` descriptor in the NIT, BAT or SDT as appropriate. Some services may be national and hence will be signalled with a country code and no regions, whilst others may be more local and have a primary, secondary or tertiary region definition. Services can be targeted at multiple regions. This implies that a broadcaster is able to describe the broadcast area as a set of target regions. A set may cross hierarchies, so, for example, a broadcast region may include tertiary regions that are contained in different primary regions, but logically belong to the same broadcast area because they are geographically neighbouring regions.

The advantage of creating a hierarchy is that it enables a broadcaster to perform small adaptations in one region without disturbing the neighbouring regions. For example, if new tertiary regions are added to a secondary region, then IRDs in other secondary regions or primary regions can ignore the change.

All target regions, identified by a target region descriptor in a NIT, BAT or SDT, shall be named by a target region name descriptor, defined in a NIT or a BAT. The hierarchical structure created may have variable depth. Broadcasters shall ensure an appropriate name is transmitted at each populated level and at all levels above them in the hierarchy.

4.2.7.5.2 Region selection by the IRD

The IRD needs to know which region it is located in so that it can filter the services that it can receive. This could be done using different techniques, such as:

- Using a pre-defined database to translate, for example, a zip code entered by the user into a region code.
- Asking the user questions based on the target region names being signalled.

This latter technique uses the data provided in the `target_region_name` descriptors. The IRD could ask the user a series of questions:

- 1) Select the country from all of the country codes collected from the `target_region` descriptors.
- 2) Select the primary region from all the primary regions for the selected country.
- 3) Select the secondary region from all the secondary regions that are defined within the selected primary region.
- 4) Select the tertiary region from all the tertiary regions that are defined within the selected secondary region.

Steps 2, 3 and 4 require the broadcaster to provide the names of the regions using the `target_region_name` descriptor.

At each level a question only needs to be asked if there is more than one option.

There is no requirement for a broadcaster to use all levels of the hierarchy in all regions, so some primary regions may not have any secondary regions and some secondary regions may not have any tertiary regions.

If none of the sub-regions listed are applicable, a viewer may wish to choose none of them, and the IRDs target region should then be set to the level above. For example a primary region England, may contain two secondary regions London and Manchester. A viewer in Birmingham may decide neither of secondary regions is appropriate and may wish to set their IRDs target region to the level above, which is the England primary region.

The IRD can now determine, using the scoping rules defined in clause 6.5 of ETSI EN 300 468 [1] and the `target_region` descriptor information, which services are most appropriate for its location and present a service list to the user taking this into account.

4.2.7.6 URI linkage descriptor

This descriptor is used to give a link to a resource which is available via an IP network.

When this descriptor is used in the first loop of a NIT, the provisions of clause 4.2.1.1.6 shall apply in addition to the present clause.

When using `uri_linkage_type` 0x02, this descriptor refers to a Material Resolution Server (MRS) resource as defined by ETSI TS 103 286-2 [i.23]. In this case, it may occur in several locations. These locations, and associated semantics are defined in ETSI TS 103 286-2 [i.23].

4.2.7.7 FTA content management descriptor

The FTA content management descriptor provides a means of defining the content management policy for an item of content delivered as part of a free-to-air (FTA) DVB Service. The signalling conveyed by this descriptor has been designed for use in the context of the DVB Content Protection Copy Management (CPCM) solution. However, the descriptor may also be used in a non-CPCM context.

The location of a particular instance of the descriptor defines the scope over which the defined content management policy shall apply. The rules for placement and scoping of this descriptor are defined in clause 6.2.18.1 of ETSI EN 300 468 [1].

4.2.7.8 Service Prominence Descriptor

The Service Prominence Descriptor provides a means of signalling services that require prominence according to the regulatory requirements of the AVMS-D. Implementation Guidelines for this descriptor are provided in a separate document [i.27] which also includes guidelines for DVB-I related prominence.

4.2.8 ISO/IEC 13818-1 descriptors

The ISO_639_language_descriptor which is defined by ISO/IEC 13818-1 [2] (MPEG-2), lists the different languages in which a service/event is broadcast. This descriptor may be present in the PMT. When present, the descriptor can be used by the IRD to select services or events with a language criterion. When this descriptor is used within the DVB SI bit streams the audio type field should be set to the value 0x00 (undefined).

Other descriptors defined by ISO/IEC 13818-1 [2] may also be present in DVB SI tables. The ISO 639-2 [i.20] language code is also used in DVB SI tables.

4.2.9 Unknown descriptors

If an IRD encounters a descriptor with an unrecognized tag (for example an unknown private descriptor), or in an unexpected context not defined in an applicable DVB specification, the IRD is recommended to skip over that descriptor (using the length field) and proceed with decoding the following SI data.

4.3 Program Specific Information (PSI) and DVB SI operational interaction states

For the description of a service state the following four columns of table 3 are relevant:

- Program Association Table (PAT);
- PMT;
- SDT; and
- EIT.

The possible indications given by these tables for a service are listed in table 3. The first three columns and the fifth column give the possible combinations of the existence of the four tables, the fourth column lists the relevant combinations of the running status bits in the SDT.

Receivers should take into account that PSI and SI tables may be generated independently, and that updates to them may also occur independently. Receivers should thus not assume that related updates will occur synchronously.

For information about the states of the running_status field in event information, see clause 4.1.4.

Table 3: Service state

Service present in					State of the service
PAT	PMT	SDT	SDT running status	EIT p/f	
yes	no	x	x	x	Transition state
no	yes	x	x	x	Transition state
yes	yes	no	-	x	Transition state
yes	yes	yes	x	no	Transition state
yes	yes	yes	running or undefined	yes	Service is running and broadcasting
yes	yes	yes	pausing or not running	x	Transition state
no	no	no	-	yes	Transition state
no	no	no	-	no	Idle state, corresponds to the start of the creation of a service or end state of a service
no	no	yes	running	x	Transition state
no	no	yes	pausing, not running or undefined	x	The service definition still exists => The service will broadcast again

4.4 Minimum repetition rates

4.4.1 Satellite and cable delivery systems

For satellite and cable delivery systems, where there will usually be sufficient bandwidth within a single delivery system to carry the SI, the following minimum repetition rates are specified:

- a) all sections of the NIT shall be transmitted at least every 10 s, including those for other delivery systems, if present;
- b) all sections of the BAT shall be transmitted at least every 10 s, if present;
- c) all sections of the SDT for the actual multiplex shall be transmitted at least every 2 s;
- d) all sections of the SDT for other TSs shall be transmitted at least every 10 s, if present;
- e) the TDT shall be transmitted at least every 30 s;
- f) the TOT (if present) shall be transmitted at least every 30 s;
- g) all sections of the EIT Present/Following Table for the actual multiplex shall be transmitted at least every 2 s;
- h) all sections of the EIT Present/Following Table for other TSs shall be transmitted at least every 10 s, if present;
- i) all SAT sections describing the actual delivery system should be transmitted at least every 10s.

The repetition rates for further EIT tables will depend greatly on the number of services and the quantity of related SI information. The following transmission intervals should be followed if practicable but they may be increased as the use of EIT tables is increased. The times are the consequence of a compromise between the acceptable provision of data to a viewer and the use of multiplex bandwidth.

- a) all sections of the EIT Schedule Table for the first 8 days should be transmitted at least every 10 s, including those for other TSs, if present;
- b) all sections of the EIT Schedule Table for further than 8 days ahead should be transmitted at least every 30 s, including those for other TSs, if present.

4.4.2 Terrestrial delivery systems

For terrestrial delivery systems bandwidth within a single transmitted TS is a valuable resource and in order to safeguard the bandwidth allocated to the primary services receivable from the actual multiplex, the following minimum repetition rates are specified in order to reflect the need to impose a limit on the amount of available bandwidth used for this purpose:

- a) all sections of the NIT shall be transmitted at least every 10 s;
- b) all sections of the BAT shall be transmitted at least every 10 s, if present;
- c) all sections of the SDT for the actual multiplex shall be transmitted at least every 2 s;
- d) all sections of the SDT for other TSs shall be transmitted at least every 10 s if present;
- e) the TDT shall be transmitted at least every 30 s;
- f) the TOT (if present) shall be transmitted at least every 30 s;
- g) all sections of the EIT Present/Following Table for the actual multiplex shall be transmitted at least every 2 s;
- h) all sections of the EIT Present/Following Tables for other TSs shall be transmitted at least every 20 s if present.

The repetition rates for further EIT tables will depend greatly on the number of services and the quantity of related SI information. The following transmission intervals should be followed if practicable but they may be increased as the use

of EIT tables is increased. The times are the consequence of a compromise between the acceptable provision of data to a viewer and the use of multiplex bandwidth.

- a) all sections of the EIT Schedule table for the first full day for the actual TS, should be transmitted at least every 10 s, if present;
- b) all sections of the EIT Schedule table for the first full day for other TSs, should be transmitted at least every 60 s, if present;
- c) all sections of the EIT Schedule table for the actual TS, should be transmitted at least every 30 s, if present;
- d) all sections of the EIT Schedule table for other TSs, should be transmitted at least every 300 s, if present.

4.4.3 PSI repetition rates

Clause 4.1.7 of ETSI TS 101 154 [i.7] gives recommendations for the maximum time intervals between repetitions of PSI sub_tables. Distribution applications should follow these recommendations, since longer repetition intervals would adversely affect service acquisition and service scanning times.

4.5 Terrestrial systems

4.5.0 General rules

The definition of the term "network" in terrestrial systems allows for different implementations. A terrestrial network may be based:

- exclusively on the MFN mode. In this case each cell of the network is operating in MFN mode for all transport streams of the network;
- exclusively on the SFN mode. In this case each cell of the network is operating in SFN mode for all transport streams of the network;
- on a mixture of the MFN and SFN mode. In this case some cells of the network may be operating in MFN mode and some others may be operating in SFN mode. It is also possible for some transport streams from a cell to be broadcast in the MFN mode, whereas other transport streams from the same cell may be broadcast in the SFN mode.

It is possible to overlay networks, so that the receiver might receive transport streams from more than one network at the same time. Emitting sites may broadcast transport streams from different networks.

A transport stream which belongs to one network is however not allowed to differ from one transmitter to another except for:

- a) different audio, video and data components due to regional variations;

NOTE: The receiver might toggle between components with different content since the transmission of different local components is not signalled.

- b) SI describing other transport streams (for instance all "other" sub_tables) which may be different.

PSI and SI describing the transport stream itself (for instance all "actual" sub_tables) shall remain unchanged.

4.5.1 The use of alternative frequencies for multiplexes

The NIT shall signal the use of possible alternative frequencies. One or more of the following three signalling methods may be implemented. Each provides progressively more specific information to the IRD and may help providing faster methods to find usable frequencies. Receivers should check which of the signalling methods are being used:

- 1) Use the other_frequency_flag in the terrestrial_delivery_system descriptor to advise the IRD that the identical multiplex may be receivable on other centre frequencies. The IRD may, for example, try scanning for a more reliable signal.
- 2) Use the frequency_list_descriptor in order to provide a list of all the possible frequencies used in transmitting a particular multiplex within the network. This descriptor is in the second descriptor loop of the NIT and so it is

specific to a single transport stream. The IRD may, for example, try to determine the best signal to use at the time.

- 3) Use the `cell_frequency_link_descriptor` in order to provide the frequency used in a particular cell to transmit a particular multiplex within the network. This descriptor is in the second descriptor loop of the NIT. A mobile IRD may try to determine those of the alternative frequencies that are probably used at its actual position.

Where the `frequency_list_descriptor` or the `cell_frequency_link_descriptor` are used, it is strongly recommended that the list for each transport stream reflects the same order of emitting sites. Thus, if there are two transport streams in a network each being emitted from the same three emitting sites, then the order in the frequency list descriptor should, for both transport streams, be:

- `emitting_site_1`;
- `emitting_site_2`;
- `emitting_site_3`.

Where one of the emitting sites does not broadcast a particular transport stream the corresponding frequency in the list should be set to zero.

In many cases a receiver will receive all of the available transport streams from a single aerial position. These descriptors can be used to aid the receiver in finding a "best first guess" of the frequency. The IRD can then try first the alternative frequency for a second multiplex which is in the corresponding position within the list for the receivable frequency for the first multiplex.

Table 4: Use of ordered alternative frequency lists

	station_1	station_2	station_3
frequency list for multiplex_A	frequency_1, A	frequency_2, A	frequency_3, A
frequency list for multiplex_B	frequency_1, B	frequency_2, B	frequency_3, B

Where a network covers a large geographical area, it is possible that different emitting sites may use the same frequency for different transport streams. It is therefore important to the viewer that the IRD ensures that the services provided are those which are requested.

In some places, an IRD may be able to receive signals from more than one emitting site which carry different networks. If an IRD receives a signal from one emitting site, it would normally only have information about services from that site. The use of NIT other and SDT other is recommended to assist the IRD in finding the services from the other networks. Even though a NIT may indicate that a transport stream is available it does not guarantee that the stream can be received by the IRD. It is important that the IRD should ensure the availability of the service before offering the service to the viewer for selection.

For optimization of the network coverage, operators can broadcast the same transport stream in a network on alternative frequencies using different modulation parameters. The modulation parameters in the `terrestrial_delivery_system_descriptor` apply to the frequency indicated in the `terrestrial_delivery_system_descriptor` and may not always apply to alternative frequencies. When the IRD uses an alternative frequency to tune to a transport stream it should not rely on those modulation parameters indicated in the `terrestrial_delivery_system_descriptor`.

Allocation of `network_ids` can be found in ETSI TS 101 162 [i.2].

4.5.2 Regional or local services

The insertion of local services is an important feature of terrestrial TV systems (see figure 4). The aim is to have a principal service which, at some precise time, may be displaced in order to provide a regional or local service. There are several methods for achieving this.

The simplest method is to broadcast multiple variants of a principal service, each containing different local programming. Each instance will have different identifiers and indicates the variation of the content in the service name.

EXAMPLE: If the principal service is called "TV", the variation for the south-east might be called "TV SE".

A better method would be to broadcast all variants of the service using the same service name, and use the target region descriptors [1] to allow receivers to present the appropriate service.

Another way would be for a regional service to occupy the same bandwidth as the principal service at the moment of the switch. This method allows for better use of bandwidth, but requires strict constraints on stream preparation and receiver behaviour to allow seamless switching.

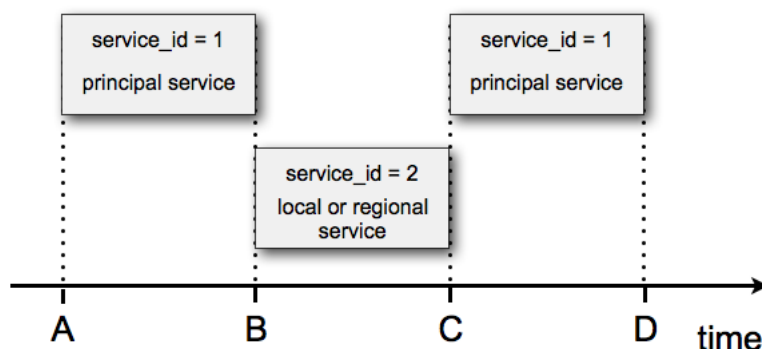

Figure 4: Simple replacement of a principal service by a regional or local service

At time B the principal service, service_id = 1, is displaced by a locally provided service, service_id = 2. This runs from time B to time C at which time the principal service, service_id = 1, is restored. Up to time A the service_id = 1 has a running_status set to "running" and service_id = 2 has a running_status set to "not running". The changes in the SI tables reflect the more precisely timed changes in the PSI tables and streams.

During the period when service_id = 2 is not providing a service it is a null service. This can be achieved by simply providing a reference to the service in the SDT only. PAT and PMT data are not required at this time (see clause 4.3). It is not necessary to provide any video or audio packets and thus the overhead incurred by this null service is reduced to the bits involved in the SDT entry.

The running-status permits the setting of an intermediate state "starts in a few seconds". The IRD may use this period to prepare for the change. At the time of the change the appropriate data, audio and video streams for service_id = 2 are introduced whilst those for service_id = 1 are simultaneously ceased. At the point of change service_id = 1 will become a null service.

The process reverses when service_id = 2 terminates. It may be thought preferable for operational reasons to provide a number of still picture frames, either at black or using a viewable picture, in order to accommodate the effect of switching to a fresh video and audio stream.

The path to the replacement service shall be indicated by the linkage_descriptor using the linkage_type "service replacement service".

More complex service switching operations can be envisaged (see figure 5). These include switching from two services to a single higher bitrate service and from three services to two higher bitrate services. In either case the changes in the SI tables will reflect the more precisely timed changes in the PSI tables and streams. The IRD has to decide what to do at the end of the service replacement. In many cases the IRD will be able to determine that the identity of the service to which it should return from the identity of the service from which it switched. The automatically determined choice may not necessarily be correct. Receivers are recommended to implement a user confirmation when switching.

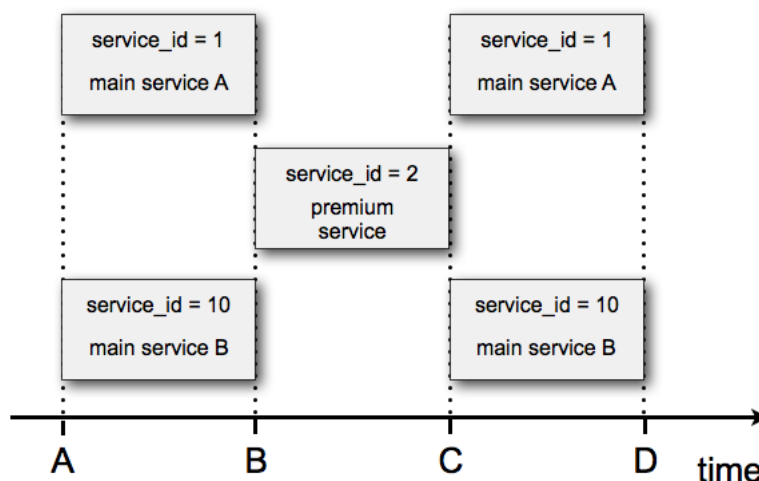

Figure 5: More complex replacement of two main services by a premium wider bandwidth service

4.5.3 Hand-over

4.5.3.1 General description of the requirements

A stationary or portable IRD can assume that a transport stream on a given frequency will be constantly available during its operation. In contrast, a mobile IRD will face the situation that the selected transport stream signal is no longer available on the tuned frequency if the IRD is moving out of the reception area. In order to continue the selected service, the mobile IRD then needs to automatically select and tune a different frequency carrying either exactly the same transport stream or a different transport stream containing the same service.

If the IRD moved from one cell to another cell of the same network, the same set of transport streams will be available but they will be on different frequencies. The mobile IRD has to determine on which frequency the lost transport stream is transmitted in the entered cell.

If the IRD moved from a cell belonging to one network into a cell of another network then the lost transport stream is not necessarily available. The IRD might want to find out if the service that had been selected before is available on some transport stream of the entered network or if there are alternative services to select.

- a) If the previously selected service is still available, the IRD needs to determine the transport stream that carries the service and the frequency of that transport stream in the entered network.
- b) If the service is not available, the IRD might try to select an alternative service (which could be a local variation of the original service or an associated service) before it prompts the user for a decision. Deploying this mechanism, co-operating networks might provide automatic hand-over between services of similar program type or services which provide additional information such as traffic announcements.

Figure 6 shows the two general hand-over situations: hand-over from one cell to another cell of the same network (network II) and the hand-over between cells of different networks (from network I to network II).

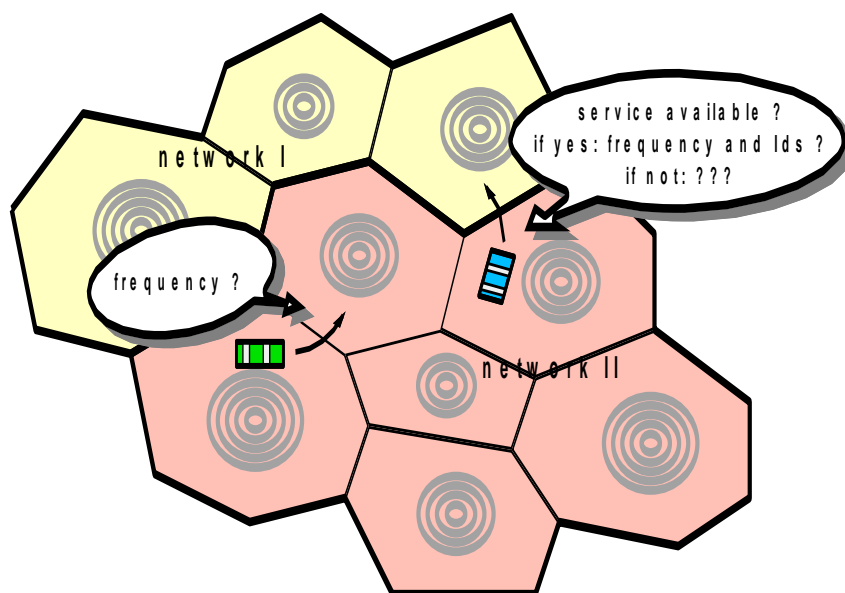

Figure 6: Hand-over situations in DVB-T networks

4.5.3.2 Hand-over by means of the frequency_list_descriptor

If a network consist of multiple cells, then for each transport stream the centre frequency used in one cell is given in the terrestrial_delivery_system_descriptor. To support mobile hand-over, the frequency_list_descriptor should be used to give the complete list of additional frequencies for a multiplex which is transmitted from multiple cells. Knowing all available centre frequencies, the IRD only needs to test those frequencies for a sufficient signal strength, decode the transport stream, and check for the same pair of original_network_id and transport_stream_id.

When the mobile IRD crosses a network border, the previously acquired frequencies may no longer lead to the same transport stream. To support mobile hand-over across network boundaries, NIT sub_tables for the neighbouring networks should be transmitted. If the transport stream is also carried in the neighbouring networks, then the IRD will be able to find the same transport stream again by testing the frequencies given in the NIT-other sub_tables for the same pair of original_network_id and transport_stream_id.

If the same transport stream is not transmitted in the "newly entered" network, the last possibility is to check the service_list_descriptor of each transport stream to find the service_id of the previously selected service and use that transport stream. Note that this method can only be deployed if the neighbouring networks are using unique, coordinated service_id values.

The actual number of frequencies to be tested strongly depends on the network layout. If a network tries to reuse same frequencies for a transport stream in as many cells as possible, then the actual number of frequencies to be tested will be less than the number of cells. If all neighbouring networks that provide the same transport stream use coordinated frequencies, then again the number of different frequencies can be less than the number of neighbouring networks.

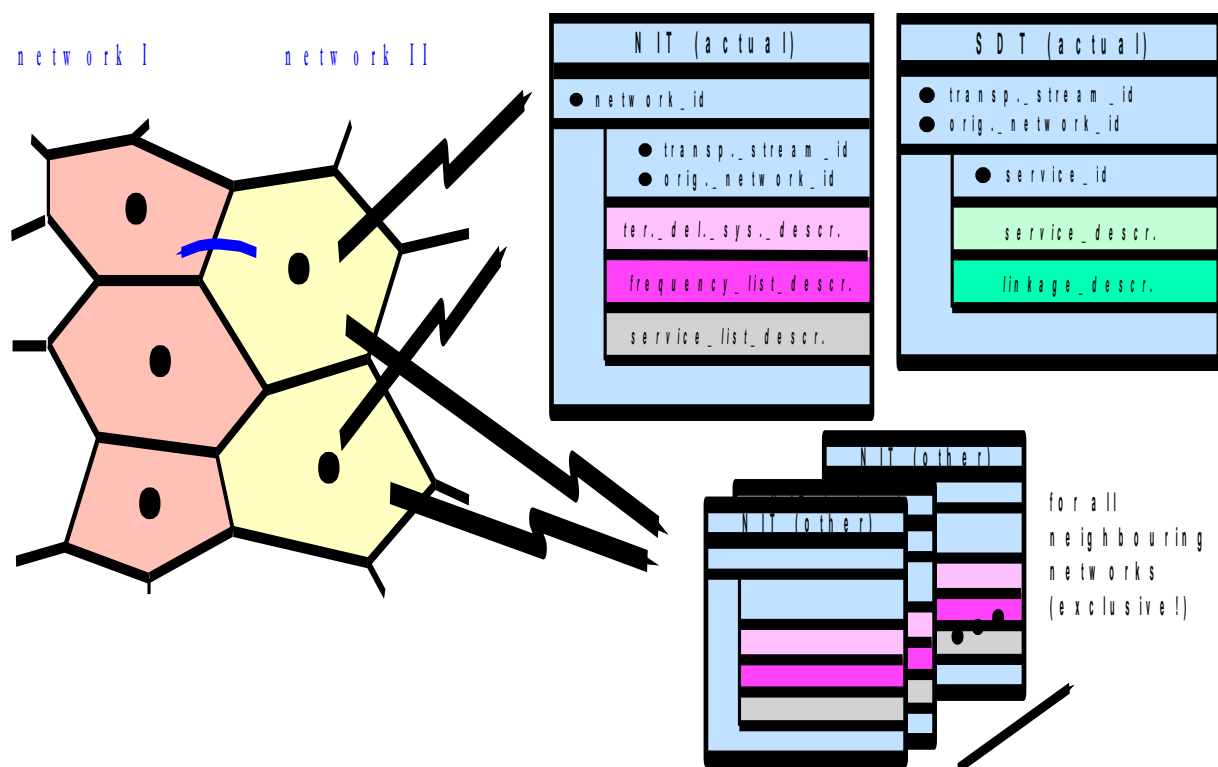

Figure 7: Hand-over at network borders by means of the frequency_list_descriptor and the service_list_descriptor

4.5.3.3 The occurrence of tuning failures

Apart from a full frequency scan, the hand-over method described above is the simplest that can be implemented on the basis of the terrestrial_delivery_system_descriptor and the frequency_list_descriptor in conjunction with the service_list_descriptor. The disadvantage of this solution is that tuning failures may occur that lead to a visible or audible service interruption. The occurrence of tuning failures is shown in figure 8.

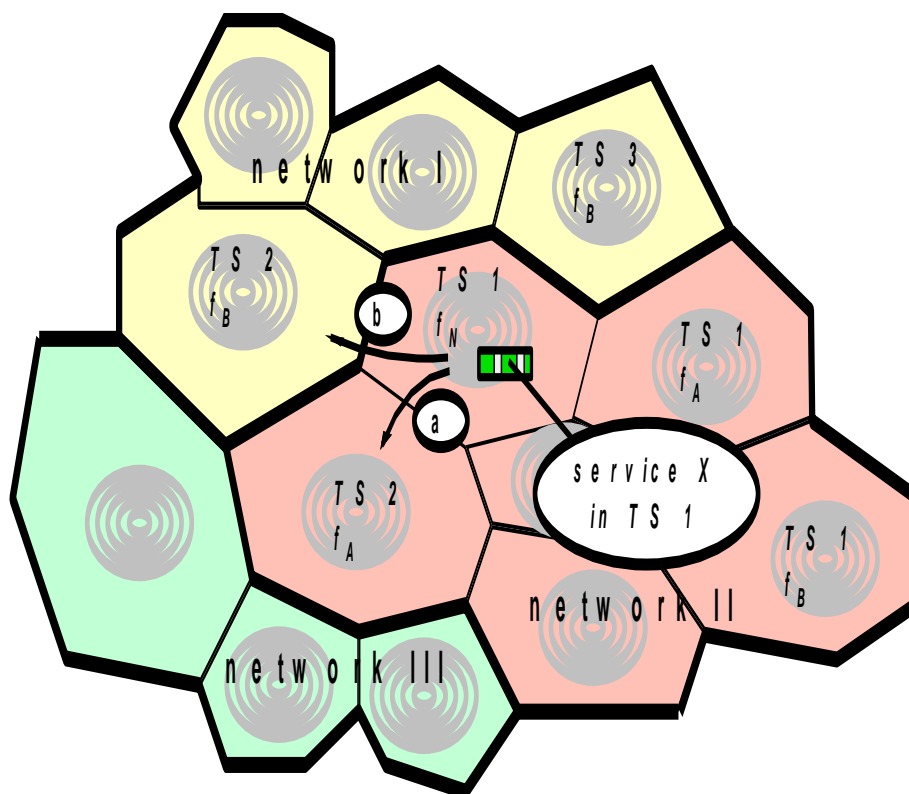

Figure 8: The occurrence of tuning failures

In network II the selected service (service X) is part of transport stream TS 1. At the current position of the receiver this transport stream is transmitted on frequency f_N . Reaching a cell border the receiver will check the alternative frequencies given in the NIT actual and other sub_tables. In the NIT actual of network II the frequencies f_A and f_B are listed as alternative frequencies for transport stream TS 1.

If the receiver moved to another cell of the same network (case a), the test on frequency f_A would lead to a sufficient signal strength and the receiver starts to decode transport stream TS 2. Only after decoding TS2 the receiver can detect this tuning failure and switch to the next alternative frequency.

If the receiver moved to a cell of network I (case b), the frequency f_A will not carry a signal but testing f_B again leads to sufficient signal strength and the receiver starts to wrongly decode transport stream TS 2 of network I.

The risk of tuning failures is proportional to the number of alternative frequencies that are used to transmit a single transport stream in the different cells of a network. Note that a tuning failure in this context is the event where a receiver has decoded a transport stream that is different (by means of the original-network-id and transport-stream-id) from the transport stream that the receiver intended to decode.

4.5.3.4 Hand-over methods with a reduced risk of tuning failures

4.5.3.4.0 General principles

The risk of tuning failures can be reduced if the number of alternative frequencies that need to be tested is minimized. Some different approaches are described below. Note that these mechanisms require unique service-id's across transport streams and networks if service hand-over between varying transport streams in co-ordinated networks shall be successful.

4.5.3.4.1 Local SI insertion

One possibility is to make each cell a separate network (each network consists of only one cell) described by individual Service Information. The transport streams of the actual cell are then described with the NIT actual while all neighbouring cells are described by corresponding NIT other sub_tables.

Hence, the frequency for a transport stream of the actual cell is given in the `terrestrial_delivery_system_descriptor` in the NIT actual and the alternative frequencies for the surrounding cells (networks) can be found in the `terrestrial_delivery_system_descriptor` of the corresponding transport stream in the NIT other sub_tables. The `frequency_list_descriptor` is not used.

In this way, the receiver only needs to check the frequencies of the same transport stream in the surrounding cells and, by the geographical network layout the number of surrounding cells is typically limited to six or less. Depending on the geographical conditions, the number of actually different frequencies can be even less than the number of surrounding cells. Thus, the probability of tuning failures can be minimized by appropriate network planning and frequency reuse.

4.5.3.4.2 Cell identification

In those cases where a local SI insertion is not possible the reduction of relevant alternative frequencies can be achieved if the receiver knows to which cell the current signal belongs, what the neighbouring cells are and which frequency is used in which cell.

The following components provide this information:

- The `cell_frequency_link_descriptor` is similar to the `frequency_list_descriptor` but it also identifies the cells and the subcells for which the frequencies are valid.
- The `cell_list_descriptor` describes the coverage area of all the cells that belong to a network.
- The `cell_id` transmitted in the TPS bits (ETSI EN 300 744 [i.6]).

Using the `cell_id` enables the receiver to determine which cell has been entered and to reduce the number of frequencies to be tested to those for the current and neighbouring cells.

4.5.3.4.3 Performance enhancement with GPS data

If the receiver knows its actual position, for example it might use position data from an additional GPS receiver, then it will be able to determine which cell will be entered before the actual network border has been reached. This calculation depends on the geographical dimensions of the actual and surrounding cells given with the `cell_list_descriptor`. Knowing the cell that will be entered, the frequency used in that cell can be determined beforehand by using the `cell_frequency_link_descriptor`. However, it might not always be possible to exactly determine the destination cell, for example if the position is at a juxtaposition of three cells. Nevertheless, the risk of tuning failures can be dramatically reduced, especially if leaving large SFN cells.

4.5.3.4.4 Two front-end solution

The risk of tuning failures can completely be eliminated by means of a second front-end, provided that:

- a) a second demultiplexer is available; or
- b) `cell_id`, `cell_list_descriptor` and `cell_frequency_link_descriptor` are supported.

Furthermore, only a two front-end solution offers the possibility to make the duration of a successful hand-over shorter.

4.5.3.5 Performance considerations

Figure 9 gives an overview of the hand-over mechanisms that have been described before. They are arranged according to the performance with respect to the risk of service interruption. The performance of all solutions can additionally be enhanced by means of a second front-end and a second demultiplexer.

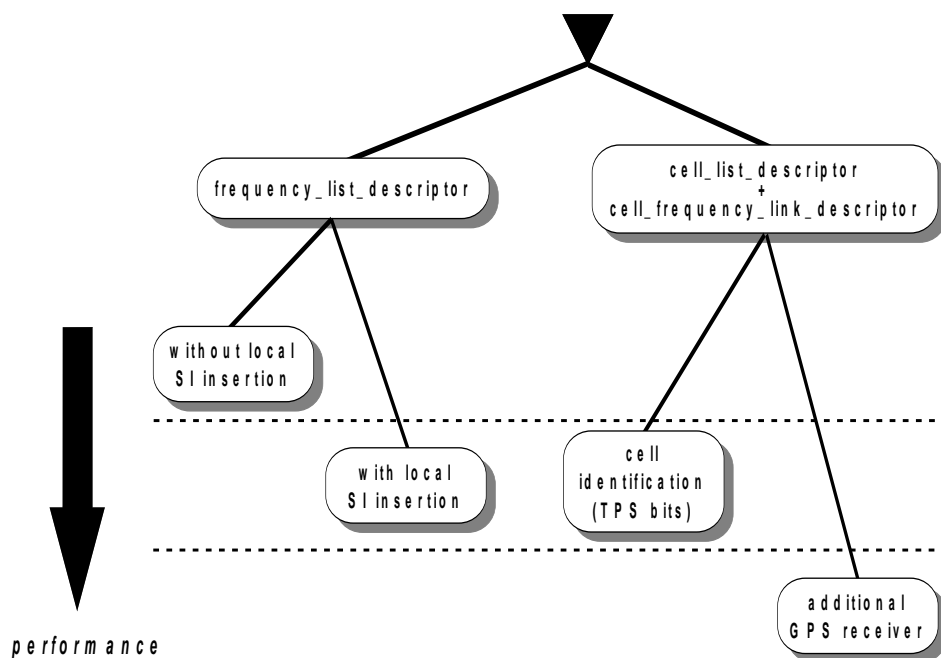

Figure 9: Performance analysis for the hand-over

4.5.3.6 Receiver guidelines for hand-over

4.5.3.6.1 Hand-over by means of the frequency_list_descriptor

- a) Prior knowledge:
 - The user has selected a certain service. The service_id, the transport_stream_id, and the original_network_id of this actual service can be derived from the SDT.
- b) Prior considerations:
 - The receiver has to collect all alternative frequencies from the frequency list descriptor, if present, by the following method:
 - Use of the alternative frequencies used in the actual network. These frequencies can be found in the NIT-actual, namely in the loop that describes the transport stream with the same transport_stream_id and the same original_network_id. Both the terrestrial delivery system descriptor and the frequency list descriptor have to be taken into account.
 - Use of one or more alternative frequencies used in neighbouring networks for the same transport_stream_id and the same original_network_id. These frequencies can be found in the NIT-other, if present. The receiver has to check all networks given in the NIT-other. If the same transport stream (i.e. with the same transport_stream_id and the same original_network_id) also exists in the neighbouring network, the alternative frequencies can be found in the same way as for the actual network. If the same transport stream does not exist in the neighbouring network, the receiver should search for the same service with the same service_id and original_network_id in the service list descriptors of all transport streams listed in the second loop of the NIT-other. If successful, the frequencies of the matching transport streams are also valid alternatives.

- c) If the reception deteriorates below acceptable levels:
- The receiver has to find a new frequency, that means, it has to tune to the alternative frequencies one by one until a frequency with acceptable reception has been found. The receiver has then to read the PAT and to check if the transport stream containing the service of interest is available.

4.5.3.6.2 Hand-over by means of cell identification

- a) Prior knowledge:
- The user has selected a certain service. The `service_id`, the `transport_stream_id`, and the `original_network_id` of the actual service can be derived from the SDT. Furthermore, the receiver can determine the `cell_id` by means of the TPS bits.
- b) Prior considerations:
- The receiver has to determine the neighbouring cells. For that purpose it has to compare the location of the actual cell with the location of other cells. Corresponding information is given in the `cell_list_descriptor`, if present. The receiver should check both, the cells of the actual network and, if the NIT-other is available, the cells of neighbouring networks.
 - Thereafter, the receiver has to determine the frequencies that are used in the neighbouring cells:
 - If a neighbouring cell is part of the actual network the receiver can directly read the `cell_frequency_link_descriptor` that may be present for the actual transport stream in the NIT-actual.
 - If a neighbouring cell is part of another network the receiver has to check first whether the transport stream of interest is available in this other network or not:
 - If the transport stream is available, the receiver can read the `cell_frequency_link_descriptor` that may be present in the NIT-other for the transport stream with the same `transport_stream_id` and `original_network_id`.
 - If the transport stream is not available, the receiver has to search for the same service in other transport streams. If a service with the same `service_id` and `original_network_id` can be found, the information in the `cell_frequency_link_descriptor` of the transport stream that carries the service can be used. If no service with matching identifiers can be found, other means can be used to find suitable replacement services, for example `linkage_descriptor` information.

NOTE: When the receiver is searching within the `cell_frequency_link_descriptor` for those `cell_ids` that have been identified as `cell_ids` of neighbouring cells, it may have to examine the frequencies used in these cells as well as further transposer frequencies that are used in subcells of these cells.

- c) If the reception deteriorates below acceptable levels:
- The receiver has to find a new frequency, that means, it has to tune to the alternative frequencies one by one until a frequency with acceptable reception is found. The receiver can then read the TPS data and check whether it contains the `cell_id` of interest or not.

4.5.3.6.3 Hand-over by means of cell description and GPS position

For this method to be used, both, the `cell_list_descriptor` and the `cell_frequency_link_descriptor` have to be present:

- a) Prior knowledge:
- The user has selected a certain service. The `service_id`, `transport_stream_id`, and the `original_network_id` of the actual service can be derived from the SDT. Furthermore, the receiver knows the frequency to which it is tuned and, by means of an additional GPS receiver, its position.

- b) Prior considerations:
 - The `cell_list_descriptor`, the `cell_frequency_link_descriptor`, and the tuned frequency can be used to determine the actual and neighbouring cells or subcells. By also considering GPS information, this can be used to determine one or more cells the receiver will probably need to tune to next. The frequency of these cells, and the frequencies used in the subcells of these cells, can be determined as explained for the previous method.
- c) If the reception deteriorates below acceptable levels:
 - The receiver has to tune to the alternative frequencies one by one until a frequency with acceptable reception and the required service is found.

4.5.3.6.4 Hand-over with two-front-end solutions

- a) Prior knowledge:
 - Identical to one of the scenarios mentioned above (depending on the actual solution).
- b) Prior considerations:
 - Identical to one of the scenarios mentioned above (depending on the actual solution).
- c) If the reception deteriorates below acceptable levels:
 - While still presenting the service on the actual frequency the receiver might use the other front-end to tune to alternative frequencies in order to check the reception of these frequencies. In this way the number of alternative frequencies can be reduced to the relevant ones in advance. Furthermore, tuning failures can be avoided:
 - If both, the `cell_frequency_link_descriptor` and the cell identification by means of the `cell_id` in the TPS bits is supported, the set of frequencies to examine can be reduced to those with a matching `cell_id`. Note that `cell_id` is only unique within the scope of an `original_network_id`.
 - If a second demultiplexer is available, the receiver is able to read the PAT transmitted on the alternative frequency. Note that the second demultiplexer can also be used to shorten the service interruption during the transition process from one frequency to another.

4.5.3.7 Additional linkage modes

Most of the hand-over requirements can be fulfilled by means of the comparison methods that have been described so far. For some specific purposes which are not covered by the comparison methods above, the `linkage_descriptor` provides a linkage type for mobile hand-over that is sub-divided into three different hand-over types:

- 1) The service identifiers of a service that is offered in more than one country will probably differ from country to another. In order to support a hand-over even when crossing country boundaries the hand-over type "hand-over to an identical service in the neighbouring country" (`hand-over_type` 0x01) can be used.
- 2) If the neighbouring network does not provide exactly the same service but a local variation of the service, the hand-over type "hand-over to a local variation of the same service" (`hand-over_type` 0x02) can be used. If this hand-over type is signalled and the EIT present of the actual service indicates by the presence of a content descriptor with a `content_nibble_level_1` of 0xB and a `content_nibble_level_2` of 0x5 that the actual content is "local or regional" then the receiver should avoid the hand-over as long as possible in order to minimize toggling between different content.
- 3) If the neighbouring network does not provide the actual service but there is an associated service available, the hand-over type "hand-over to an associated service" (`hand-over_type` 0x03) can be used. An associated service may be one that offers comparable content, e.g. traffic alerts. When this hand-over type is used, the receiver should avoid the hand-over as long as possible in order to minimize toggling between different content.

The hand-over linkage for a particular service may occur in either the SDT or the NIT.

4.5.3.8 Additional remarks

In order to support an optimum hand-over it is highly recommended that service providers uses only one service_id for one service even if DVB allows to allocate several service_ids for one service.

In distinction from the DAB system [i.14] the DVB-T systems does not support the estimation of the position by the interpretation of signals from different transmitters or repeaters at well-known positions since the DVB-T systems does not allow the identification of a specific transmitter or repeater within a SFN.

4.6 Text string formatting

4.6.0 General rules

Strings in SI may be transmitted using different encodings (ETSI EN 300 468 [1], annex A). Therefore the control characters described in this clause may appear in the decoded stream, but may appear in an encoded form in the transmitted string.

4.6.1 Use of control codes in names

Name fields are found in the descriptors shown in table 5.

Table 5: Name fields

bouquet_name_descriptor, multilingual_bouquet_name_descriptor	bouquet name
network_name_descriptor, multilingual_network_name_descriptor	network name
service_descriptor, multilingual_service_descriptor	service provider name service name
short_event_descriptor	event name
target_region_name_descriptor	region name

The following rules apply to the use of control codes in these name fields:

- a) It is expected that the range of name lengths transmitted might vary significantly. It is also expected that IRDs may have some limitations in the text length that can be displayed. Such limitations may depend on the method of display in use at the time. For example an IRD may be able to present the time-schedule of events in a graphical format, but only with a short label for each event.

The following mechanism allows a short section of a name to be identified. This uses the emphasis control codes with the following interpretation in the name fields:

- 0x86 short_name_on;
- 0x87 short_name_off.

These codes may only be used in pairs, and the short_name_off code should be preceded by the short_name_on code. Use of the codes to identify a short name in any name field is optional.

EXAMPLE: The [0x86]Asterix[0x87] Digital Satellite TV Network

(short name: AnExampleTV).

The [0x86]P[0x87]ay [0x86]M[0x87]ovie [0x86]C[0x87]hannel

(short name: PMC).

- b) The use of the CR/LF code is not recommended in name fields.

4.6.2 Use of control codes in text

Text fields are found in the descriptors shown in table 6.

Table 6: Text fields

short_event_descriptor:	text
extended_event_descriptor:	item description
component_descriptor, multi-lingual_component_descriptor	component description
data_broadcast_descriptor	description of data broadcast service

The following rules apply to the use of control codes in these text fields:

- a) The "emphasis character on code" indicates that the IRD is recommended to emphasize the display of text which follows this code, e.g. by using bold or highlighted characters, and the "emphasis character off code" indicates when an IRD should revert to the normal character display.

EXAMPLE: The winners are announced of the [0x86]£10million[0x87] draw.
 Is J.R. [0x86]really[0x87] dead ?

- b) The CR/LF code is used to indicate points in the text where the IRD is recommended to start on a new line, i.e. it indicates new paragraphs. The IRD is expected to perform automatic word-wrapping to suit its text display width.
- c) The use of the Soft-HYPHEN code (SHY in the character coding tables) is recommended to indicate possible hyphenation points in long words.

4.6.3 Use of UTF-8

By restricting the encoding to the Basic Multilingual Plane, the maximum length of any UTF-8 encoded character is three bytes.

Those characters with an encoding of 0x007F or less map to the standard ASCII encoding within UTF-8, and hence are compatible with those ASCII encodings. The character set selection mechanism is preserved and UTF-8 encoding only need be signalled where strings require characters with encodings greater than 0x7F.

5 Applications

5.0 Introduction

The SI syntax is designed to work under a wide range of operation conditions. Clause 5 describes some applications and explains how SI can be used in such an environment.

5.1 NVOD services

The MPEG-2 specification provides the means of transmitting several video programmes simultaneously in a single TS, which allows for the possibility of a broadcaster to provide a Near Video On Demand (NVOD) service.

This clause describes how such a service could be implemented and how it is described within the Service Information (SI).

The concept of providing a NVOD service where several time shifted versions of the same programme are transmitted simultaneously is not a new one, but it was not until the advent of the DVB System that the system became a viable one. Figure 10 shows the concept using six time-shifted versions of a service.

This is the simplest form of such a service where all the programmes are identical on all of the channels (other forms could exist where for example the interstitial breaks could be different).

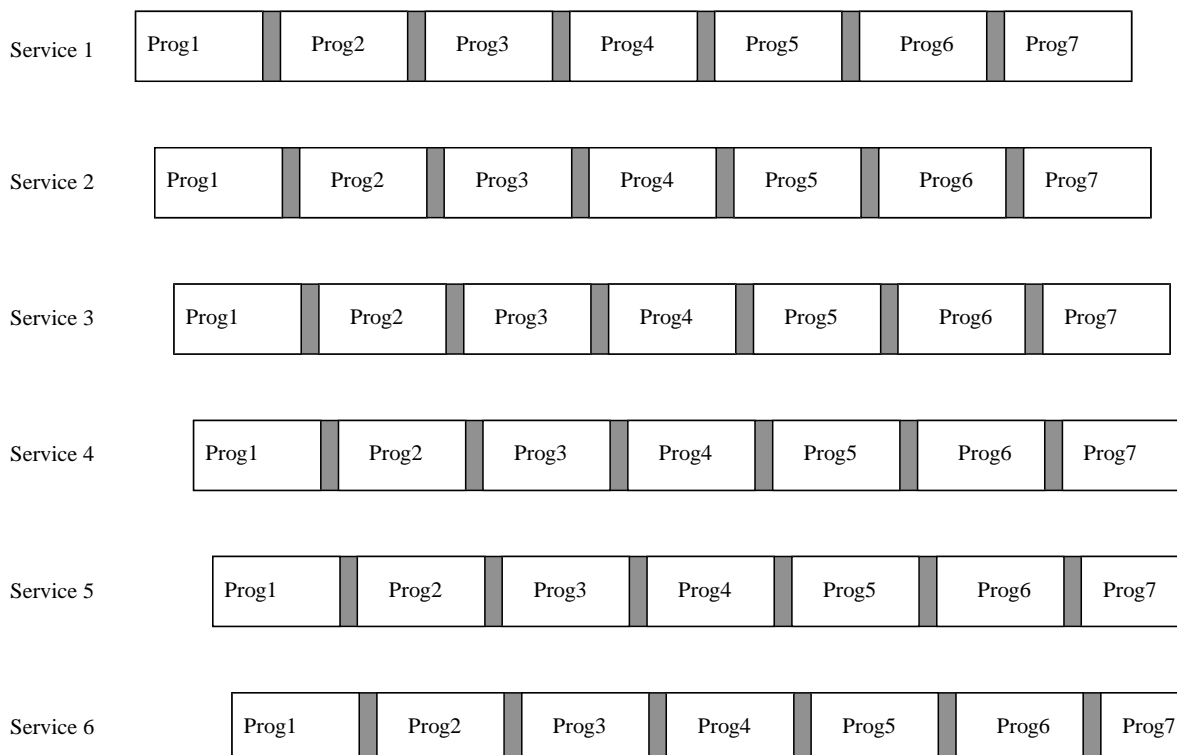

Figure 10: Example of a NVOD service

To describe such a NVOD service with conventional SI would require the repetition of six Event Information Tables (EIT). Instead the concept of a reference service is used.

The reference service is a fictitious service and provides a means within the SI of associating the actual time shifted services (services 1 to 6).

This reference service is allocated a `reference_service_id` which links a common description of the events within the service for all the services belonging to the NVOD service. The EIT of the reference service can always be found in the TS in which the NVOD services are located. Each time shifted service is given a full reference in terms of `transport_stream_id`, `original_network_id`, `service_id` and these services are listed in the `NVOD_reference_descriptor`. In addition, each time shifted service is described by a `time_shifted_service_descriptor` which points back to the reference description. This is shown in figure 11.

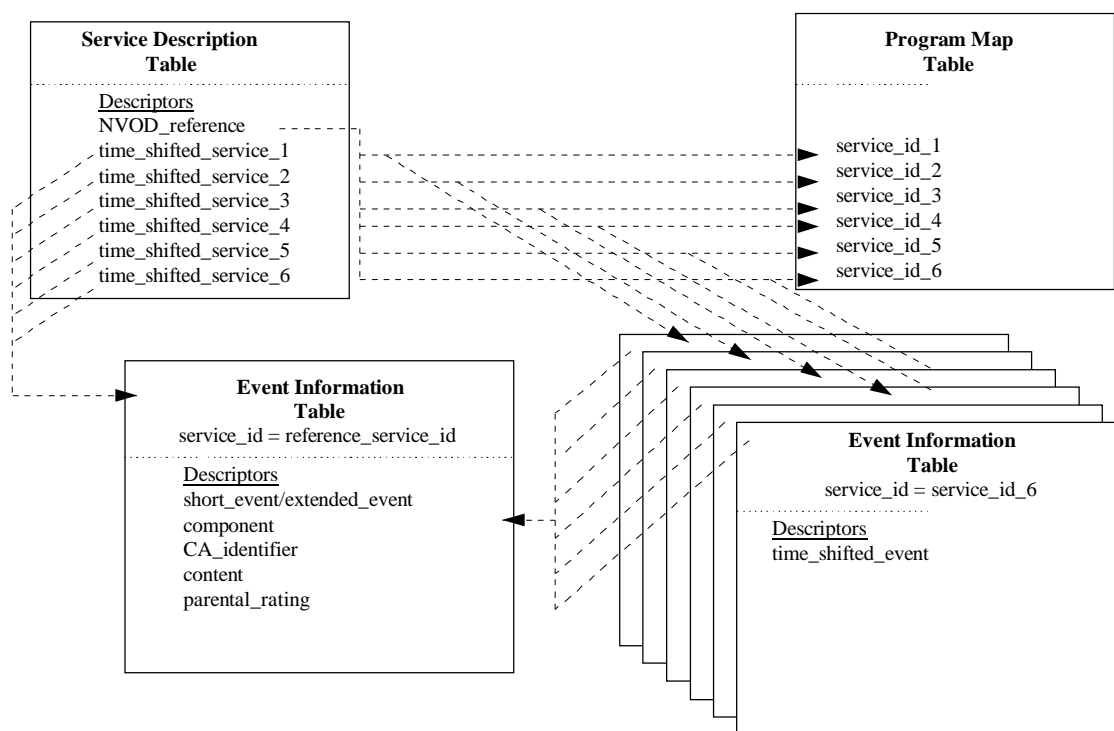

Figure 11: SI description of NVOD services

Using this method reduces the amount of data by nearly five times. The start times in the EIT for the reference service are set to void values of all "1"s, the correct start times for each event being given in the EITs of the respective time shifted services. All the events of the NVOD reference service (i.e. all the events which are referenced from the associated EIT present/following and EIT schedule tables of the associated time-shifted services) shall be described in the EIT present/following table of the NVOD reference service.

5.2 Mosaic services

5.2.1 General considerations

Mosaic services can be spread out over several TSs. A complete mosaic system can be organized in a tree structure.

A mosaic component is a collection of different video images to form a coded MPEG-2 video stream. The merging of the video images is performed at the source level, in such a way that at the display each image will occupy a specific area of the screen.

Each specific area is called a logical cell. Logical cells are composed of elementary cell(s). The mosaic screen is subdivided by a maximum of 8×8 elementary cells. Each elementary cell is numbered. A logical cell is a collection of elementary cells. Each logical cell is identified by a unique logical_cell_id.

The mosaic descriptor identifies the elementary cells (see figure 12), groups different elementary cells to form logical cells (see figure 13), and establishes a link between the content of all or part of the logical cell and the corresponding information carried in the SDT or EIT or BAT. Thus there is a close association between the mosaic descriptor and other SI Tables. The mosaic descriptor may be placed in either or both of the SDT and PMT sections for the mosaic service. Use in the SDT reduces the amount of interaction between the DVB SI and MPEG Tables. However, a single mosaic service containing multiple video components can only be described by having the mosaic descriptor appearing multiple times within the PMT section. Some logical cells may have no link to SI (see figures 12 and 13).

5.2.2 Relationship between mosaic service and SI/PSI Tables

Algorithm to look for a mosaic service:

- a) check the SDT Tables (actual TS / other TSs);

- b) if a mosaic service exists:
- go to the corresponding TS;
 - process the PAT and PMT;
 - display the mosaic service;
 - look after the content of the mosaic service:
 - if you are interested by the content of one logical cell and if it is related to:
 - a bouquet: display the information of the corresponding BAT, go forward or cancel;
 - a service: display the information of the corresponding SDT, process the PAT and the PMT and display the selected service;
 - an event: display the information of the corresponding EIT, process the PAT and the PMT and display the selected event;
 - a mosaic service: display the information of the corresponding SDT, process the PAT, the PMT, display the selected mosaic service, and go to "- look after the content of the mosaic service".

0	1	2	3
4	5	6	7
8	9	10	11
12	13	14	15

0	1	2	3	4	5	6	7
8	9	10	11	12	13	14	15
16	17	18	19	20	21	22	23
24	25	26	27	28	29	30	31
32	33	34	35	36	37	38	39
40	41	42	43	44	45	46	47
48	49	50	51	52	53	54	55
56	57	58	59	60	61	62	63

Figure 12: Example elementary cell organizations

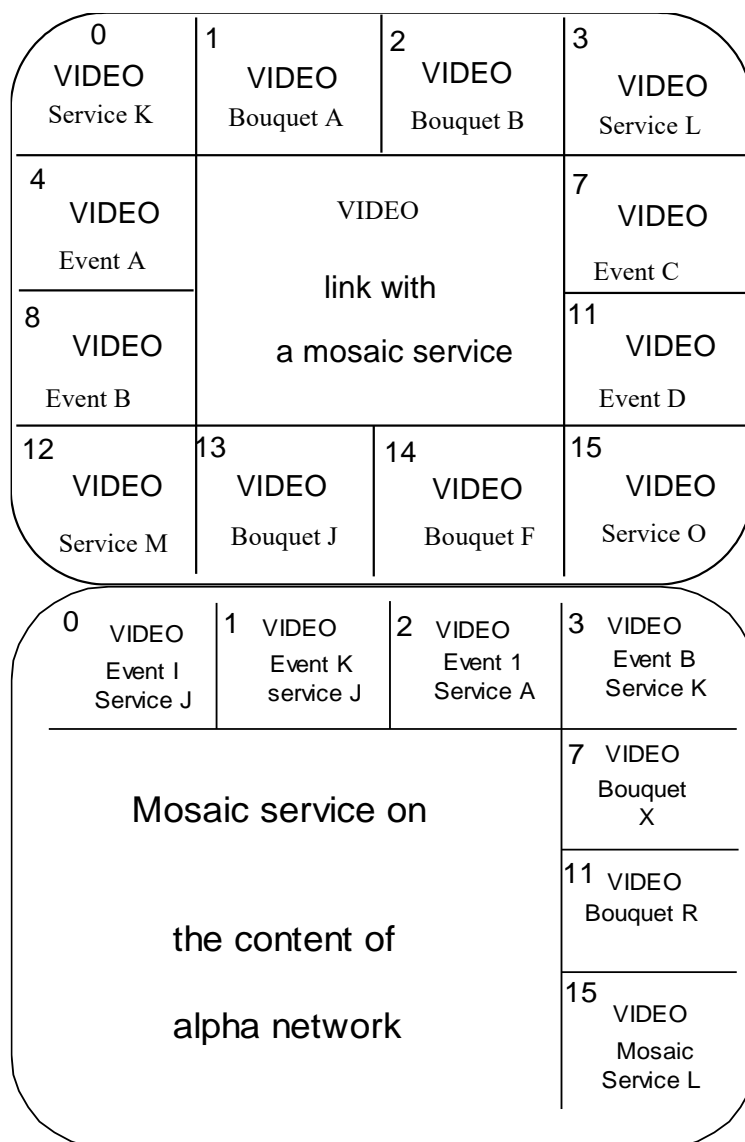

Figure 13: Examples of logical cell organization and content

5.3 Transitions at broadcast delivery system boundaries

5.3.0 Introduction

A very common broadcast delivery system infrastructure will be, that signals received from the a satellite are converted and rebroadcast on a cable network. Depending on the size of the network, various technical options exist to facilitate these transitions.

5.3.1 Seamless transitions

A simple and low-cost solution is to remove the Quadrature Phase Shift Keying (QPSK) modulation from a satellite signal and replace it with a Quadrature Amplitude Modulation (QAM) suitable for the cable system or a modulation system suitable for (Satellite) Master Access TeleVision ((S)MATV). This mode is usually called a seamless transition. The major complication in this seamless mode is that the bit stream is left unchanged, which causes the NIT to be invalid for the actual delivery system to which the IRD is connected, for example a cable or SMATV system.

Seamless transitions are supported by the SI System, with the proviso that it is readily possible for the IRD to identify whether the NIT information is valid. The rules of operation specified in clause 4.1.1 permit invalid NIT data in the case that applicable delivery system descriptors are not given for the actual delivery system.

EXAMPLE: If a satellite IRD receives a satellite delivery system descriptor for the actual delivery system, then it is valid. If a cable IRD receives a cable delivery system descriptor for the actual delivery system, then it is valid. If a cable IRD receives a satellite delivery system descriptor for the actual delivery system, then it is assumed to be invalid for the cable IRD.

The NIT is intended to simplify the set-up and installation procedure for the viewers, and to signal changes of tuning information. However, since it is impossible after a seamless transition of a broadcast delivery system boundary always to maintain valid information in the NIT, the IRD may require mechanisms in addition to reception of the NIT to obtain tuning data.

The support of seamless network transitions is based on the definition of a unique identification mechanism for a TS. The `transport_stream_id` field, as specified in the MPEG-2 standard, allows 65 536 TSs to be uniquely identified. If `transport_stream_id` values are uniquely assigned to multiplex originators in Europe, this number is considered too small. Thus, the range of unique identifications of TSs has been extended in the DVB SI by a field called `original_network_id` of 16 bits. The concatenation of these 2 fields results in 4 294 967 296 unique identifiers for TSs. This gives sufficient room to allow for a unique identification of TSs without requiring a registration procedure.

Given this unique identification of the TSs, it is then possible to build IRDs that do not require a correct NIT for correct installation purposes. In order to support seamless transitions of TSs for small cable systems and SMATV it is highly recommended that IRDs are able to initiate a frequency scan and store the unique TS identifiers with the sets of delivery system parameters. With this procedure the same information as carried in the NIT can be obtained. However, the presence of a NIT does provide certain advantages for installation set-up and network management purposes.

In a seamless mode of operation, an IRD is able to detect the permitted instances of incorrect NIT data, even though no modifications to the bit stream have been made. In general, a network transition will occur between two different types of networks, e.g. from satellite to cable. In this case, the detection of an incorrect NIT is based on the value of the `descriptor_tag` in the NIT's `delivery_system_descriptor`.

If the transition is between networks of the same type, the NIT should be replaced (see clause 5.3.2) by either a valid NIT or a NIT for another type of network. After the detection of an incorrect NIT, the IRD should be able to initialize itself correctly, e.g. by using a frequency scanning procedure.

5.3.2 Non-seamless transitions without re-multiplexing

A slightly more complex option is to restore the TS packet bit stream and to perform some selective TS packet replacements in the TS. Such a packet replacement option does not require a re-timestamp operation and is of relatively low complexity. Some error handling operations need to be implemented in order to deal with the unrecoverable errors in the satellite signal and with lost TS packets. The NIT is carried in TS packets with a unique Packet Identifier (PID) value which allow the replacement function to be based on simple PID filter logic.

If a network transition is based on a TS packet replacement function, it is desirable that the new NIT information is stored and managed at the network boundary. This is the logical location, as each network operator will demand the control over the frequency allocation in his network. For this local control to be as simple as possible, a fixed PID value is selected for TS packets carrying NIT data. A certain minimum data rate for the transmission of NIT data is specified in clause 4.1.1 to allow the replacement function to meet the minimum repetition time for the replacement NIT.

5.3.3 Transitions with re-multiplexing

The most complicated and expensive solution is to combine two or more TSs into a single one at the broadcast delivery system boundary. This re-multiplexing also involves the re-timing of the TS packets and the generation of a new SI data stream. The SI data in other TSs might in this case also be incorrect, which requires the checking and regeneration of the SI data in all TSs in the network. This option will only be feasible for very large networks.

5.4 Announcements

DVB supports spoken announcements of several types. They can dynamically occur during any event. If a certain service supports such announcements, the corresponding SDT shall indicate this by means of a `announcement_support_descriptor`. This descriptor gives information about which types of announcements may occur and where the announcements will occur. This can either be in the audio stream which is currently decoded or in other audio streams on the same or on a different transport stream.

The dynamic flags which trigger the real time announcement switching are encoded in the private data bytes of the adaptation field. The syntax of the `announcement_switching_data_field` is defined in ETSI EN 300 743 [i.13]. This data field is present only in those streams that carry announcements. Services that support announcements by means of giving a reference to announcement streams will not provide this `announcement_switching_data_field` in their streams. Thus, the demultiplexer has to monitor the adaptation field of the announcement stream if the support of announcements is realized by referencing an announcement stream. If a reference is made to an announcement stream in a different TS a copy of the announcement switching data field has to be embedded in the actual TS, namely in the audio stream of a service that uses the reference to an announcement stream in a different TS. The service and the stream that carries this duplicated trigger information is also indicated by the `announcement_support_descriptor` of the SDT.

5.5 Mosaic and picture-in-picture services using VVC subpictures

5.5.1 General considerations

The VVC specification provides a technology, called VVC subpictures, for easy merging and/or extracting of a rectangular region of an image from a VVC bitstream, without the need for decoding, reencoding or generally modifying the syntax of the slice NAL units of the bitstream. This capability is useful for applications such as personalization and accessibility. Two such applications are mosaic and picture-in-pictures as described in ETSI TS 101 154 [i.7] Annex M.

5.5.2 Mosaic services using VVC subpictures

5.5.2.1 Usage of the VVC subpictures descriptor for mosaic services

One possible personalization service consists in providing a mosaic service to a user who can select one of the programs only. The VVC subpicture corresponding to the selected program can be extracted from the bitstream, before decoding and presenting the extracted part to the user, as illustrated in Figure 14.

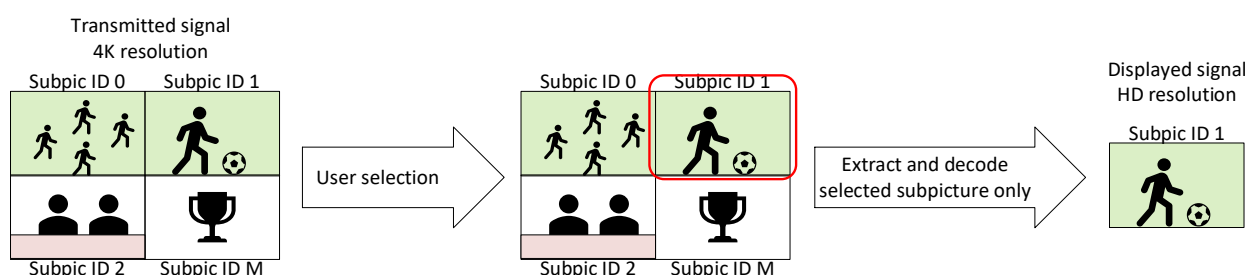

Figure 14: Example of user selection in a VVC mosaic service using VVC subpictures

The video mosaic will typically be created at the source and transmitted within a single PID. In case different audio bitstreams are associated to each image of the mosaic, each program within the mosaic may be described by a different PMT, whereby all PMTs would point to the same video PID containing the mosaic video bitstream, and each PMT would contain one VVC subpicture descriptor. If the same audio is used for all images of the mosaic, only one PMT may be necessary to signal the service, whereby that PMT would contain several VVC subpictures descriptors, one for each image of the mosaic intended to be consumed by a user.

A reason content providers might want to use multiple PMTs is if different audio bitstreams or subtitles are used for different parts of the mosaic. Another reason may be that content providers would like receivers to tune by default to a particular part of the mosaic.

Each video stream within the PMT or PMTs shall contain a stream identifier descriptor to signal a component_tag for the video stream and a VVC subpictures descriptor to signal which VVC subpicture within the video stream with the corresponding component_tag corresponds to that program. A receiver would then need to extract the correct VVC subpicture for that program, either before decoding by extracting the NAL units corresponding to the VVC subpicture, or after decoding by extracting the corresponding rectangular area.

5.5.2.2 Example signalling with several PMTs

The example below uses several PMTs: each PMT corresponds to one version of the service and contains only one default VVC subpictures descriptor.

An example signalling within the PMT for the example of Figure 14 may be:

```

stream_type           0x33 (for a VVC bitstream)
elementary_PID        (mosaic video PID value)
VVC_video_descriptor (containing the corresponding information for the VVC bitstream)
stream_identifier_descriptor:
  component_tag       1
vvc_subpictures_descriptor:
  default_service_mode 1
  service_description_present 0
  number_of_vvc_subpictures 1
  component_tag       1
  vvc_subpicture_id   1
  processing_mode     010 (extraction of VVC subpicture necessary at the receiver)

```

Another PMT for the version of the service corresponding to the mosaic image with subpicture ID 2 in Figure 14 may be:

```

stream_type           0x33 (for a VVC bitstream)
elementary_PID        (mosaic video PID value, same as in the first example PMT above)
VVC_video_descriptor (containing the corresponding information for the VVC bitstream)
stream_identifier_descriptor:
  component_tag       1
vvc_subpictures_descriptor:
  default_service_mode 1
  service_description_present 0
  number_of_vvc_subpictures 1
  component_tag       1
  vvc_subpicture_id   2
  processing_mode     010 (extraction of VVC subpicture necessary at the receiver)

```

The example of Figure 14 would typically require four such PMTs, one for each image of the mosaic.

Alternatively, the VVC subpictures descriptor for each version of the service may be signalled in the SDT or also in the EIT for a particular event in case the mosaic is applied only on an event basis.

5.5.2.3 Example signalling with only one PMT

The example below uses only one PMT for the example mosaic service of Figure 14 (whereby M means any integer number corresponding to the subpicture ID as encoded in the VVC bitstream). The example PMT contains several VVC subpictures descriptor, one for each version of the service. For the sake of completeness, the following example also contains a VVC subpictures descriptor corresponding to the whole mosaic as the default one, in case it makes sense for a user to display the whole mosaic (for example for the purpose of selecting one of the views).

```

stream_type                0x33 (for a VVC bitstream)
elementary_PID             (mosaic video PID value)
VVC_video_descriptor      (containing the corresponding information for the VVC bitstream)
stream_identifier_descriptor:
    component_tag          1
vvc_subpictures_descriptor:
    default_service_mode   1
    service_description_present 1
    number_of_vvc_subpictures 4
    component_tag          1
    vvc_subpicture_id      0
    component_tag          1
    vvc_subpicture_id      1
    component_tag          1
    vvc_subpicture_id      2
    component_tag          1
    vvc_subpicture_id      M
    processing_mode        001 (no processing necessary at the receiver)
    char                    "whole mosaic"
vvc_subpictures_descriptor:
    default_service_mode   0
    service_description_present 0
    number_of_vvc_subpictures 1
    component_tag          1
    vvc_subpicture_id      0
    processing_mode        010 (extraction of VVC subpicture necessary at the receiver)
vvc_subpictures_descriptor:
    default_service_mode   0
    service_description_present 0
    number_of_vvc_subpictures 1

```

component_tag	1
vvc_subpicture_id	1
processing_mode	010 (extraction of VVC subpicture necessary at the receiver)
vvc_subpictures_descriptor:	
default_service_mode	0
service_description_present	0
number_of_vvc_subpictures	1
component_tag	1
vvc_subpicture_id	2
processing_mode	010 (extraction of VVC subpicture necessary at the receiver)
vvc_subpictures_descriptor:	
default_service_mode	0
service_description_present	0
number_of_vvc_subpictures	1
component_tag	1
vvc_subpicture_id	M
processing_mode	010 (extraction of VVC subpicture necessary at the receiver)

5.5.3 Picture-in-picture services using VVC subpictures

5.5.3.1 Usage of the VVC subpictures descriptor for picture-in-picture services

Picture-in-picture services offer the ability to include a picture with a small resolution within a picture with a bigger resolution. The video with the bigger resolution may be called the main video, while the video with the small resolution may be called the supplementary video. One use case for a picture-in-picture service is to offer accessibility by supplementing the main video with sign language. Another use case may be to display a sport event in the main video and a related but different one in the supplementary video during a competition. VVC subpictures may also be used for a VVC picture-in-picture service by using both the extracting and merging properties of VVC subpictures. When a user wants to consume the main version of the program, no processing is necessary. When a user wants to consume the picture-in-picture version of the program, the subpicture that corresponds to the picture-in-picture area of the main video is extracted from the main bitstream and replaced by the supplementary bitstream, as illustrated in **Error!**

Reference source not found..

6 Storage media

6.0 General principles

A recording device can store a partial bitstream from the DVB TS. This partial bitstream does not carry any DVB SI data other than the Selection Information Table (SIT) described in ETSI EN 300 468 [1]. The SIT contains a summary of all SI information in the broadcast stream relevant for storage media. All relevant MPEG-2 PSI information should be coded to correctly describe the partial MPEG-2 TS.

The presence of the SIT in a bitstream flags the bitstream as a partial bitstream coming from the digital interface. This allows the IRD to ignore the absence of any mandatory SI tables and only use information coded into the SIT.

In addition to the SIT table, a second table, called Discontinuity Information Table (DIT), is defined in ETSI EN 300 468 [1]. This table is to be inserted at transition points at which SI/PSI information may be discontinuous. The IRD may use this information to recapture the SI/PSI information. Note that it is not necessary to signal normal changes to the SI/PSI information, for example an event transition, which are covered by the table version signalling mechanism.

6.1 Program Association Table (PAT)

The PAT only lists selected services. In addition, the `network_PID` reference should take the value of the `SIT_PID` instead of the `NIT_PID`. The references to non-selected programs/services should be removed. The PAT should not violate the MPEG-2 Systems rules.

6.2 Program Map Table (PMT)

The PMT should not violate the MPEG-2 Systems requirements.

For selected services, the corresponding PMT section may remain unchanged only if all elementary streams referenced from it are selected and kept unchanged. In case any of the referenced elementary streams of the service is removed or changed, the PMT section should be modified to reflect this.

For non-selected services the obsolete PMT sections may remain in the stream only if they are in the same PID as a PMT section of any selected service. In all other cases they should be removed.

6.3 SI tables (NIT, SDT, EIT, BAT, RST, TDT, TOT)

These tables should be removed after selection.

6.4 Selection Information Table (SIT)

The SIT should be packetized in TS packets starting from the beginning of the payload, i.e. in a packet with `payload_unit_start_indicator` in the TS packet header set to "1" and with the `pointer_field` set to "0x00". Furthermore, it is recommended that the SIT is packetized in a single TS packet (if possible).

The `transmission_info_loop` in SIT should contain the `partial_transport_stream_descriptor`.

The following service loop should contain all the `service_ids` of the selected services. Each instance of `service_loop` may contain descriptors from the original EIT and SDT.

6.5 Discontinuity Information Table (DIT)

At a transition, the bitstream may be discontinuous with respect to any of the SI information (including PAT and PMT). The DIT table shall be inserted at this transition point.

Whenever a partial bitstream discontinuity occurs, two transport packets belonging to PID 0x001E shall be inserted directly at the transition point, with no other packets in between. The first one shall have 184 bytes of adaptation field stuffing with `discontinuity_flag` set to "1" (in order to ensure compliance to MPEG-2 continuity counting constraints for successions of transitions introduced at independent transmission/storage stages). The second of these transport packets shall contain the "DIT" and shall not have such a flag set to "1".

Annex A (informative): Bibliography

- ATSC Document A/56: "System Information for Digital Television"

NOTE: See: <http://www.atsc.org>.

- ETSI TS 102 366: "Digital Audio Compression (AC-3, Enhanced AC-3) Standard".
- ISO/IEC 13818-2: "Information technology -- Generic coding of moving pictures and associated audio information: Video".

Annex B (informative): Change History

Date	Version	Information about changes
June 2017	1.13.1	Implemented Change Requests: <ul style="list-style-type: none"> • 1543: cross-check DVB-SI updates in EN300468 • 1719: missing subsections for PMT descriptors under 4.2.6 • 1984: update document title to remove guideline word • 2135: clarify PAT/PMT repetition rates • 969: EIT present flags contradiction • 1010: URI linkage semantics for CSS MRS • 1643: new URI linkage type for MRS identifier • 1012: clarify EITp/f mandatoryness in figure 1 • 1028: minor typo in 4.2.4.2 • 1094: update 4.2.4.6 to cover extended event linkage (and HEVC) • 1469: explain use of SDT component descriptor for HEVC • 1544: add section for Enhanced_AC-3 descriptor • 1548: add section for FTA content management descriptor • 1556: ensure that every target region has a name • 1560: disallow bouquet name descriptor in the SDT • 1592: rules for delivery system descriptors • 1593: de-duplicate terms and definitions between EN300468 and TS101211 • 1595: explain data broadcast id ranges • 1600: descriptor name typo in 4.5.3.7 • 1602: update references to ETSI TS 101 154 to TS (was TR) • 1670: add new SFC-3DTV event linkage value in 4.2.4.6 • 1673: add a revision history table at the end • 1687: add UHD-1 Phase 2 signalling • 1690: unify wording to sub_table • 1692: explain user defined range for data_service_id • 1717: fix external references for AC-3 • 2484: add new section for DTS-UHD audio PMT descriptor
November 2022	BlueBook A005r10 (Draft 1.14.1)	Added VVC mosaic and picture and picture content in section 5.5 Added AVMS-D service of general interest content in section 4.2.7.8 “Service Prominence Descriptor” Added informative reference to AVMS-D guidelines document BlueBook A183 Added DVB-S2Xv2 related content

History

Document history		
Edition 1	April 1996	Publication as ETSI ETR 211
Edition 2	August 1997	Publication as ETSI ETR 211
V1.4.1	July 2000	Publication as ETSI TR 101 211
V1.5.1	January 2003	Publication as ETSI TR 101 211
V1.6.1	May 2004	Publication as ETSI TR 101 211
V1.7.1	February 2006	Publication as ETSI TR 101 211
V1.8.1	August 2007	Publication as ETSI TR 101 211
V1.9.1	June 2009	Publication as ETSI TR 101 211
V1.10.1	December 2010	Publication
V1.11.1	April 2012	Publication
V1.11.2	May 2012	Publication
V1.12.1	December 2013	Publication
V1.13.1	May 2021	Publication
Draft V1.14.1	November 2022	DVB BlueBook A005r10 publication