



**Second Generation DVB
Interactive Satellite System
(DVB-RCS2);**

**Part 2:
Lower Layers for Satellite standard**

DVB Document A155-2 Rev.3

July 2023

DVB[®]

Contents

Intellectual Property Rights	11
Foreword.....	11
Modal verbs terminology	12
Introduction	12
1 Scope.....	14
2 References	14
2.1 Normative references	14
2.2 Informative references	15
3 Definition of terms, symbols and abbreviations.....	16
3.1 Terms	16
3.2 Symbols	19
3.3 Abbreviations.....	20
4 Two-way Satellite Interactive Satellite System models	23
4.0 Introduction.....	23
4.1 Interactive Satellite System Reference Models.....	23
4.2 System Model	23
4.3 Dynamic Connectivity	24
4.4 Reference Architectures.....	24
4.5 Protocol Stack Model.....	24
4.6 The Lower Layers.....	24
4.6.0 Introduction	24
4.6.1 Lower Layer Services.....	25
4.6.2 Lower Layer Interfaces	27
5 Forward Link and Regenerative Mesh Downlink	29
5.0 Introduction.....	29
5.1 SDU Transport in the Forward Link.....	29
5.1.0 Introduction	29
5.1.1 SDU Transport in GSE PDUs	30
5.1.1.0 Introduction	30
5.1.1.1 Implicit Integrity Protection of SDU (optional)	30
5.1.1.2 Explicit Integrity Protection of SDU	30
5.1.1.3 Maximum Transfer Unit for an SDU in the Forward Link.....	30
5.1.2 SDU Transport in TS Packets (optional).....	30
5.2 Addressing in the forward link	31
5.2.0 Introduction	31
5.2.1 Addressing of L2S.....	31
5.2.2 Addressing the Unicast Higher Layer Traffic	31
5.2.2.0 Introduction	31
5.2.2.1 Addressing Unicast Sent with GSE	31
5.2.2.2 Addressing Unicast Sent over a TS Packet stream (optional)	31
5.2.3 Addressing the Multicast Higher Layer Traffic	32
5.2.3.0 Introduction	32
5.2.3.1 Addressing Multicast over GSE	32
5.2.3.2 Addressing Multicast over TS Packet stream	32
5.3 Layer 2 FEC (optional).....	32
5.3.0 Introduction	32
5.3.1 LL-FEC Frame	33
5.3.1.0 Introduction	33
5.3.1.1 Filling of Application Data Table.....	33
5.3.1.2 Generation of the FEC Data Table	34
5.3.1.2.0 Introduction.....	34
5.3.1.2.1 Reed-Solomon Code	34

5.3.1.2.2	Raptor Code	35
5.3.2	Carriage of LL-FEC Frames	35
5.3.2.0	Introduction	35
5.3.2.1	Carriage of Application Data	36
5.3.2.1.0	Introduction	36
5.3.2.1.1	GSE-FEC application data optional header extension	36
5.3.2.1.2	NLOS Adaptation optional header extension	37
5.3.2.2	Carriage of Parity Data	38
5.3.2.3	Real-Time Parameters	40
5.4	DVB-S2(X) Physical Layer	40
5.4.0	Introduction	40
5.4.1	DVB-S2 CCM operation	41
5.4.2	DVB-S2 and DVB-S2X ACM operation	41
5.4.2.1	ACM TDM carrying TS packets (optional)	41
5.4.2.2	Single stream ACM TDM carrying GSE PDU	41
5.4.2.3	Multi-stream ACM TDM carrying GSE PDU (optional)	41
5.4.2.4	Transmission mode usage	41
5.4.2.5	PL frame usage	42
5.4.2.6	SYNC Byte Usage	42
5.4.3	FL Modulation and Coding	42
5.4.4	Symbol Scrambling	42
5.4.4.0	Introduction	42
5.4.4.1	Broadcast Type Symbol Scrambling	42
5.4.4.2	Custom Type Symbol Scrambling (optional)	42
5.4.4.3	Two-way Symbol Scrambling	43
5.4.5	Direct Sequence Spread Spectrum (optional)	43
6	Forward Link L2S	43
6.0	Introduction	43
6.1	Protocol Stack	43
6.2	Forward Link L2S Components	44
6.2.0	Introduction	44
6.2.1	Network Clock Reference Indication	44
6.2.1.0	Introduction	44
6.2.1.1	NCR in Continuous GS	44
6.2.1.2	NCR in TS Packet Stream (optional)	45
6.2.2	Broadcast Tables	46
6.2.2.0	Introduction	46
6.2.2.1	Network Information Table (NIT)	46
6.2.2.2	RCS Map Table (RMT)	46
6.2.2.3	Superframe Composition Table (SCT)	46
6.2.2.4	Frame Composition Table version 2 (FCT2)	46
6.2.2.5	Broadcast Configuration Table (BCT)	46
6.2.2.6	Satellite Position Table (SPT) and Satellite Access Tables (SAT)	47
6.2.2.7	Correction Message Table (CMT)	47
6.2.2.8	Terminal Burst Time Plan Table version 2 (TBTP2)	47
6.2.2.9	Multicast Mapping Table version 2 (MMT2)	47
6.2.2.10	Transmission Mode Support Table version 2 (TMST2)	47
6.2.2.11	Fast Access Table (FAT)	47
6.2.2.12	Supplementary Tables (optional)	48
6.2.3	Terminal Information Message (TIM)	48
6.3	Refresh and Update Intervals	48
6.4	Syntax and Coding of FL Signals for L2S	48
6.4.0	Introduction	48
6.4.1	Table and Message Identification and Placement	48
6.4.2	The NCR Packet	50
6.4.3	Transport of Configuration Tables and Messages	51
6.4.3.1	Transport in Continuous Generic Stream	51
6.4.3.1.0	Introduction	51
6.4.3.1.1	Un-addressed Lower Layer Signalling Transport in GSE Packets	51
6.4.3.1.2	Addressed Lower Layer Signalling Transport in GSE Packets	52
6.4.3.2	Transport in TS Packets (optional)	52

6.4.3.2.0	Introduction.....	52
6.4.3.2.1	Un-addressed Transport in TS Packets (optional).....	52
6.4.3.2.2	Addressed Lower Layer Signal Transport in TS Packet Stream (optional)	53
6.4.4	The SCT Content.....	55
6.4.5	The FCT2 Content.....	56
6.4.6	The BCT Content	58
6.4.6.0	Introduction	58
6.4.6.1	Format Data Block for LM Burst	59
6.4.6.2	Format Data Block for CPM Burst.....	62
6.4.6.3	Format Data Block for Continuous Transmission	64
6.4.6.4	Format Data Block for Spread-Spectrum LM Burst.....	66
6.4.7	The SPT and SAT-Content.....	69
6.4.7.0	Introduction	69
6.4.7.1	The SPT Content	69
6.4.7.2	The SAT Content.....	70
6.4.8	The CMT Content	70
6.4.9	The TBTP2 Content	71
6.4.10	The NIT Content	73
6.4.11	The RMT Content	74
6.4.12	The MMT2 Content	75
6.4.13	The TMST2 Content	76
6.4.14	The TIM Content.....	78
6.4.15	The Fast Access Table Content (optional)	79
6.4.16	Supplementary SI Tables Content (optional)	79
6.4.17	The Descriptors	80
6.4.17.0	Introduction	80
6.4.17.1	Correction Message Descriptor	80
6.4.17.2	Control Assign Descriptor	81
6.4.17.3	Echo Value Descriptor.....	82
6.4.17.4	Linkage Descriptor	82
6.4.17.5	Satellite Return Link Descriptors	83
6.4.17.5.0	Introduction.....	83
6.4.17.5.1	Satellite Return Link Descriptor	84
6.4.17.5.2	Satellite Return Link v2_Descriptor	85
6.4.17.6	Satellite Forward Link Descriptors.....	86
6.4.17.6.0	Introduction.....	86
6.4.17.6.2	Satellite Forward Link Descriptor.....	86
6.4.17.6.3	Satellite Forward Link_v2 Descriptor.....	89
6.4.17.7	Logon Contention Descriptor	90
6.4.17.8	Correction Control Descriptor	91
6.4.17.9	Mobility Control Descriptor	91
6.4.17.10	Correction Message Extension Descriptor	92
6.4.17.11	Void.....	93
6.4.17.12	Implementation Type Descriptor (optional)	93
6.4.17.13	LL FEC Identifier Descriptor (optional).....	94
6.4.17.14	Frame Payload Format Descriptor.....	96
6.4.17.15	Pointing Alignment Support Descriptor	98
6.4.17.16	Forward Link Streams Descriptor (optional).....	100
6.4.17.17	Lower Layer Service Descriptor.....	100
6.4.17.18	Logon Response Descriptor.....	103
6.4.17.19	DHCP Option Descriptor.....	104
6.4.17.20	TRANSEC Message Descriptor	105
6.4.17.21	Transmission Offset Descriptors	106
6.4.17.21.0	Introduction.....	106
6.4.17.21.1	Transmission Offset Descriptor	106
6.4.17.21.2	Transmission Offset V2 Descriptor	107
6.4.17.22	RCS Content Descriptor (optional)	108
6.4.17.23	Logon Security Descriptor (optional)	109
6.4.17.24	Random Access Load Control Descriptor	109
6.4.17.25	CLI Instruction Descriptor (optional)	110
6.4.17.26	Random Access Traffic Method Descriptor (optional).....	111
6.4.17.27	Network Layer Info descriptor	112

6.4.17.28	Higher Layers Initialization descriptor	112
6.4.17.29	Lowest Software Version descriptor	113
6.4.17.30	Mesh System descriptor (optional)	114
6.4.17.31	Extension Protocol descriptor (optional)	115
6.4.17.32	Continuous Carrier Control Descriptor (optional)	115
6.5	Transmission of Forward Link L2S Data Structures	117
7	Return Link and Mesh Uplink.....	117
7.0	Introduction.....	117
7.1	Return Link Logical Link Control	119
7.1.0	Introduction.....	119
7.1.1	SDU Transport in the Return Link	119
7.1.2	Maximum Transfer Unit for an SDU in the Return Link	119
7.2	Return Link Medium Access Control	119
7.2.0	Introduction.....	120
7.2.1	The Addressed Link PDU (ALPDU)	120
7.2.1.0	Introduction	120
7.2.1.1	Addressed Link PDU Format and Syntax.....	120
7.2.1.1.0	Introduction.....	120
7.2.1.1.1	compressed_protocol_type Field	121
7.2.1.1.2	protocol_type Field	122
7.2.1.1.3	alpdu_label_byte Field (optional).....	122
7.2.1.1.4	sdu_byte Field.....	122
7.2.1.1.5	fragmenting_alpdu	123
7.2.1.1.6	sequence_number Field	123
7.2.1.1.7	alpdu_crc Field (optional).....	123
7.2.1.2	The ALPDU Label	123
7.2.1.3	Identifying the Transmission Resources for the ALPDU	123
7.2.1.4	Mapping the ALPDU to Available Payload	124
7.2.1.4.0	Introduction.....	124
7.2.1.4.1	Forwarding the ALPDU in One Payload-adapted PDU.....	124
7.2.1.4.2	Forwarding the ALPDU Using Several Payload-adapted PDUs	124
7.2.1.4.3	Integrity Protection of a Fragmented ALPDU	124
7.2.1.4.4	Multiplexing Payload-adapted PDUs used for Different ALPDUs	124
7.2.2	The Payload-adapted PDU (PPDU)	124
7.2.2.0	Introduction	124
7.2.2.1	start_indicator and end_indicator Fields.....	126
7.2.2.2	ppdu_length Field.....	126
7.2.2.3	fragment_id Field.....	126
7.2.2.4	alpdu_label_type Field	127
7.2.2.5	protocol_type_suppressed Field	127
7.2.2.6	ppdu_label_byte Field (optional)	127
7.2.2.7	use_alpdu_crc Field.....	127
7.2.2.8	total_length Field	127
7.2.2.9	alpdu_byte Field.....	127
7.2.2.10	The PPDU Label (optional).....	128
7.2.3	The Frame PDU	128
7.2.3.1	Context Differentiation of the Frame PDU.....	128
7.2.3.2	The Frame PDU Format and Syntax	129
7.2.3.3	The Payload Label	130
7.2.4	Lower Layer Addressing by the RCST	131
7.2.4.0	Introduction	131
7.2.4.1	Addresses used for Lower Layer Signalling towards NCC	131
7.2.4.2	Lower Layer Addressing of SDUs	131
7.2.4.2.0	Introduction.....	131
7.2.4.2.1	Transparent Star.....	131
7.2.4.2.2	Transparent Mesh.....	132
7.2.4.2.3	Regenerative Mesh.....	133
7.2.4.3	Virtual Network Addressing.....	133
7.2.5	Random Access.....	133
7.2.5.0	Introduction	133

7.2.5.1	Channels for Random Access	133
7.2.5.1.1	Timeslots for Random Access Logon	133
7.2.5.1.2	Timeslots for Random Access Control (optional).....	133
7.2.5.1.3	Timeslots for Random Access User Traffic (optional)	133
7.2.5.2	Random Access Methods	134
7.2.5.2.0	Introduction.....	134
7.2.5.2.1	Slotted Aloha	134
7.2.5.2.2	CRDSA (optional)	134
7.2.5.3	Resources for contention	138
7.2.6	Dedicated access	138
7.2.6.0	Introduction	138
7.2.6.1	Channels for Dedicated access	138
7.2.6.1.1	Timeslots Dedicated to an RCST and for Logon Burst.....	138
7.2.6.1.2	Timeslots Dedicated to an RCST and for Control Burst.....	138
7.2.6.1.3	Timeslots Dedicated to an RCST and for Traffic/Control Content.....	138
7.2.6.1.4	Timeslots Dedicated to an RCST and for Traffic Content.....	139
7.2.6.1.5	Carrier Dedicated to an RCST and for Traffic/Control Content	139
7.2.6.2	Unsolicited Resources for Dedicated access	139
7.2.6.3	Solicitation for Resources for Dedicated access	139
7.2.6.3.0	Introduction.....	139
7.2.6.3.1	Volume Based Dynamic Capacity	140
7.2.6.3.2	Rate Based Dynamic Capacity (RBDC)	140
7.2.6.3.3	Requests per request class.....	141
7.2.6.3.4	Limitation of the Requested Level of Resources	141
7.2.6.3.5	Carrier for Continuous Transmission (Option)	141
7.2.7	Burst Time Plan Distribution	141
7.2.8	Assignment of a Carrier for Continuous Transmission (Option)	142
7.3	Transmission Bursts.....	142
7.3.1	Transmission Burst Content Type.....	142
7.3.2	Burst Waveform	142
7.3.3	Energy Dispersal	143
7.3.4	Payload CRC.....	143
7.3.5	Coding and Interleaving	144
7.3.5.0	Introduction	144
7.3.5.1	The Turbo FEC Encoder for Linear Modulation	144
7.3.5.1.0	Introduction.....	144
7.3.5.1.1	Turbo Code Permutation.....	145
7.3.5.1.2	Circulation of Initial State.....	146
7.3.5.1.3	Rates and Puncturing Map	146
7.3.5.2	Convolutional Encoder for CPM.....	147
7.3.5.2.0	Introduction.....	147
7.3.5.2.1	The FEC Encoder for CPM.....	148
7.3.5.2.2	Trellis Termination	149
7.3.5.2.3	The Bit-interleaver for CPM	149
7.3.6	Inclusion of Known Symbols.....	151
7.3.6.0	Introduction	151
7.3.6.1	Burst Construction for TC-LM and SS-TC-LM	151
7.3.6.2	Burst Construction for CC-CPM	152
7.3.7	Modulation	152
7.3.7.0	Introduction	152
7.3.7.1	Linear Modulation of Burst	152
7.3.7.1.0	Introduction.....	152
7.3.7.1.1	Baseband Shape and Group Delay	152
7.3.7.1.2	Preamble and Post-amble Symbols.....	153
7.3.7.1.3	Pilot Block Symbols	153
7.3.7.1.4	Payload Symbols.....	153
7.3.7.1.5	Direct-Sequence Spreading.....	157
7.3.7.2	Continuous Phase Modulation of Burst.....	157
7.3.7.2.0	Introduction.....	157
7.3.7.2.1	Continuous Phase Modulation Signal and Pulse Shaping	157
7.3.7.2.2	Continuous Phase Modulation Bit to Symbol Mapping.....	158
7.3.7.2.3	Phase Trellis Termination	159

7.3.8	Burst Transmission Power Envelope	160
7.3.9	Transmission Burst Timing	161
7.3.9.0	Introduction	161
7.3.9.1	Burst Transmission Start Accuracy	162
7.3.9.2	Symbol Clock Accuracy	162
7.3.9.3	Carrier Frequency Accuracy	162
7.4	Void	162
7.5	The Return Link Structure (MF-TDMA)	163
7.5.0	Introduction	163
7.5.1	Segmentation of the Return Link Resources	163
7.5.1.0	Introduction	163
7.5.1.1	Superframe	163
7.5.1.2	Superframe Sequence	164
7.5.1.3	Frame	164
7.5.1.4	Timeslot	166
7.5.2	Guard time	166
7.5.3	The Dynamic MF-TDMA Transmission Channel	166
7.5.4	The Frequency Range of the Dynamic Transmission Channel	168
7.6	Return Link Continuous Carrier (Option)	168
8	Return Link L2S	170
8.0	Introduction	170
8.1	Transport of the Logon PDU	170
8.2	Transport of the Control PDU	171
8.2.1	Transport of Control PDU in Control Burst	171
8.2.2	Transport of Control PDU multiplexed with higher layer PDUs	171
8.3	Syntax and Coding of RL Signals for L2S	171
8.3.0	Introduction	171
8.3.1	Logon PDU content	171
8.3.2	Control PDU Content	175
8.3.3	CSC Burst Issued by RCST	185
8.3.4	Transmission of Return Link L2S Data Structures	186
9	M&C Functions Supported by L2S	186
9.0	Introduction	186
9.1	Connecting the Forward Link	187
9.1.0	Introduction	187
9.1.1	Acquisition of the Forward Link Signalling	187
9.1.2	Acquisition of Multiple Forward Link Streams (optional)	188
9.1.3	Acquisition of Multiple Forward Link TDMs (optional)	188
9.2	Connecting the Return Link	189
9.2.0	Introduction	189
9.2.1	Return Link States and State Transitions	189
9.2.2	Initialize for Logon Procedure	192
9.2.3	Lower Layer Logon Procedure	193
9.2.3.0	Introduction	193
9.2.3.1	Basic Logon Procedure	193
9.2.3.2	Logon via Dynamically Allocated Logon Timeslots	195
9.2.3.3	Logon with Support for Large Timing Uncertainty	195
9.2.4	Acquiring the Superframe Sequence for Operation	196
9.2.5	TDMA Synchronization Procedure	196
9.2.6	Synchronization Monitoring Process	197
9.2.7	Logoff Procedures	198
9.2.8	Control of Continuous Carrier Transmission	198
9.3	Protocol Type Support	200
9.4	Interactive Network Entry	200
9.4.0	Introduction	200
9.4.1	Entry Type Indication	201
9.4.2	Alignment Status	201
9.4.3	Subscription Status	201
9.4.4	Higher Layers Initialization Status	201
9.4.5	Commissioning Status	202

9.4.6	Lower Layer Capabilities	202
9.4.7	Higher Layer Capabilities	202
9.4.8	Providing the unicast MAC Addresses for the Higher Layers	202
9.4.9	Lower Layer Service Assignment	202
9.4.10	Initialization of the Higher Layers	203
9.4.11	Initialization for Mesh Communication	203
9.5	Return Link Timeslot Grid Control	204
9.6	Timeslot Access Method Control	204
9.7	Random Access Load Control	204
9.7.1	Contention Control for Logon Timeslots	204
9.7.1.1	Stationary RA Load Control for Logon	204
9.7.1.2	Dynamic RA Load Control for Logon	205
9.7.2	Contention Control for Control Timeslots (optional)	205
9.7.2.0	Introduction	205
9.7.2.1	Stationary RA Load Control for Control Signals	205
9.7.3	Contention Control for Traffic Timeslots	205
9.7.3.0	Introduction	205
9.7.3.1	Stationary RA Load Control for Traffic	205
9.7.3.2	Dynamic RA Load Control for Traffic	206
9.8	Forward Link Feeder MODCOD Control	207
9.9	Control of RCST Transmission Characteristics	207
9.9.1	EIRP Control	207
9.9.2	Transmission Duration Control	208
9.9.3	Symbol Rate Control	208
9.9.4	Return Link MODCOD Control	208
9.9.5	Waveform Configuration Control	209
9.9.5.0	Introduction	209
9.9.5.1	Configuring the Waveform for TC-LM	209
9.9.5.2	Configuring the Waveform for CC-CPM	210
9.9.5.3	Configuring the waveform for CRDSA TC-LM (optional)	210
9.9.5.4	Configuring the waveform for SS-TC-LM (optional)	210
9.9.5.5	Configuring the waveform for the Continuous Carrier (optional)	211
9.9.6	Contention Diversity Transmission Control (optional)	212
9.10	Frame Payload Format Control	212
9.10.0	Introduction	212
9.10.1	Payload Content Type Control	213
9.10.2	Frame Payload Format Differentiation	213
9.10.3	Frame Payload Format Control	214
9.10.4	ALPDU Label Format Control	214
9.10.5	SDU Protocol Type Field Control	214
9.10.6	Essential Traffic Payload Structures	214
9.10.6.0	Introduction	214
9.10.6.1	Transparent Star	215
9.10.6.2	Transparent Mesh	215
9.10.6.3	Regenerative Mesh	215
9.10.6.4	Transparent Star Continuous Transmission	215
9.11	Return Link Status Supervision	216
9.12	Remote Control of the RCST	216
9.12.0	Introduction	216
9.12.1	Log Off	216
9.12.2	Hold Transmission	216
9.12.3	Wakeup	216
9.12.4	Remote Echo	216
9.12.5	SNMP Set to Remote (optional)	216
9.12.6	CLI Instruction to Remote (optional)	217
9.12.7	Network Failure and Recovery	217
9.12.8	Rain Fade Indications	217
9.13	Control of the MTU	217
9.14	Pointing Alignment Support	217
9.15	M&C of the CC operation (Option)	218
10	Mobile Terminal Operation (optional)	219

10.0	Introduction.....	219
10.1	Mobility Management.....	219
10.1.0	Introduction.....	219
10.1.1	Beam Handover.....	219
10.1.2	Satellite/Gateway Handover.....	221
10.2	Interference Avoidance.....	221
10.2.0	Introduction.....	221
10.2.1	Off-Axis EIRP Emission Density.....	222
10.2.2	Power Flux Density at the Surface of the Earth.....	222
10.2.3	Fault Conditions.....	222
11	Security.....	222
Annex A (normative): Reference waveforms.....		223
Annex B (normative): Interleaver Permutations for CC-CPM.....		232
Annex C (normative): CPM Phase response samples.....		252
Annex D (informative): Bibliography.....		254
History.....		255

Intellectual Property Rights

Essential patents

IPRs essential or potentially essential to normative deliverables may have been declared to ETSI. The information pertaining to these essential IPRs, if any, is publicly available for **ETSI members and non-members**, and can be found in ETSI SR 000 314: "*Intellectual Property Rights (IPRs); Essential, or potentially Essential, IPRs notified to ETSI in respect of ETSI standards*", which is available from the ETSI Secretariat. Latest updates are available on the ETSI Web server (<https://ipr.etsi.org/>).

Pursuant to the ETSI IPR Policy, no investigation, including IPR searches, has been carried out by ETSI. No guarantee can be given as to the existence of other IPRs not referenced in ETSI SR 000 314 (or the updates on the ETSI Web server) which are, or may be, or may become, essential to the present document.

Trademarks

The present document may include trademarks and/or tradenames which are asserted and/or registered by their owners. ETSI claims no ownership of these except for any which are indicated as being the property of ETSI, and conveys no right to use or reproduce any trademark and/or tradename. Mention of those trademarks in the present document does not constitute an endorsement by ETSI of products, services or organizations associated with those trademarks.

Foreword

This European Standard (EN) has been produced by Joint Technical Committee (JTC) Broadcast of the European Broadcasting Union (EBU), Comité Européen de Normalisation ELECTrotechnique (CENELEC) and the European Telecommunications Standards Institute (ETSI).

NOTE: The EBU/ETSI JTC Broadcast was established in 1990 to co-ordinate the drafting of standards in the specific field of broadcasting and related fields. Since 1995 the JTC Broadcast became a tripartite body by including in the Memorandum of Understanding also CENELEC, which is responsible for the standardization of radio and television receivers. The EBU is a professional association of broadcasting organizations whose work includes the co-ordination of its members' activities in the technical, legal, programme-making and programme-exchange domains. The EBU has active members in about 60 countries in the European broadcasting area; its headquarters is in Geneva.

European Broadcasting Union
CH-1218 GRAND SACONNEX (Geneva)
Switzerland
Tel: +41 22 717 21 11
Fax: +41 22 717 24 81

The Digital Video Broadcasting Project (DVB) is an industry-led consortium of broadcasters, manufacturers, network operators, software developers, regulatory bodies, content owners and others committed to designing global standards for the delivery of digital television and data services. DVB fosters market driven solutions that meet the needs and economic circumstances of broadcast industry stakeholders and consumers. DVB standards cover all aspects of digital television from transmission through interfacing, conditional access and interactivity for digital video, audio and data. The consortium came together in 1993 to provide global standardization, interoperability and future proof specifications.

The present document is part 2 of a multi-part deliverable covering the DVB Interactive Satellite System specification as identified below:

- ETSI TS 101 545-1: "Overview and System Level specification";
- ETSI EN 301 545-2: "Lower Layers for Satellite standard";**
- ETSI TS 101 545-3: "Higher Layers Satellite Specification";
- ETSI TR 101 545-4: "Guidelines for Implementation and Use of ETSI EN 301 545-2";
- ETSI TR 101 545-5: "Guidelines for the Implementation and Use of ETSI TS 101 545-3".

National transposition dates	
Date of adoption of this EN:	23 July 2020
Date of latest announcement of this EN (doa):	31 October 2020
Date of latest publication of new National Standard or endorsement of this EN (dop/e):	30 April 2021
Date of withdrawal of any conflicting National Standard (dow):	30 April 2021

Modal verbs terminology

In the present document "**shall**", "**shall not**", "**should**", "**should not**", "**may**", "**need not**", "**will**", "**will not**", "**can**" and "**cannot**" are to be interpreted as described in clause 3.2 of the [ETSI Drafting Rules](#) (Verbal forms for the expression of provisions).

"**must**" and "**must not**" are **NOT** allowed in ETSI deliverables except when used in direct citation.

Introduction

The present document is a specification of the lower layers and the lower layer embedded signalling for the management and control system, for two way interactive satellite networks specified by ETSI TS 101 545-3 [i.16]. It represents a new generation of ETSI EN 301 790 [1]. The following amendments have been made relative to ETSI EN 301 790 [1]:

- The modulation schemes are CPM, 8PSK and 16QAM, in addition to QPSK.
- The FEC for QPSK, 8PSK and 16QAM is a 16-state turbo code, commonly called Turbo-phi.
- The FEC for CPM is Convolutional Coding.
- The waveform characteristics are configurable to allow adaptation to different applications.
- A set of normative reference waveforms are specified, to support interoperability.
- The MF-TDMA burst constructions for the reference waveforms are differentiated with respect to the operating point, by balanced use of preamble, postamble and pilots so that the decoder synchronization sensitivity threshold corresponds with the payload decoding sensitivity threshold.
- The forward link packet encapsulation uses GSE as specified in ETSI TS 102 606 [8] with strengthened integrity control to comply with the recommendations for internet subnet-working as found in IETF RFC 3819 [9]. Alternative encapsulation over a TS Packet stream is supported for migration.
- The return link packet encapsulation is an adaptation of the generic stream encapsulation (ETSI TS 102 606 [8]), where the IP packets are fragmented just in time so that the fragments fit exactly into the remaining free space of varying size available in the transmission frame payloads of different size, without using an intermediate fixed frame size streaming layer like ATM and MPEG TS. This new encapsulation protocol for the return link was named RLE (Return Link Encapsulation).
- The link transport specification is generalized to suit a multitude of protocols, not only IP. This applies to the forward link as well as the return link and to the design of the RLE protocol. The support of transport of other protocols than IP is however considered implementation dependent.
- Support for random access user traffic is included.
- The framing structure of the return link is simplified.

- The payload size can be adapted by selecting a suitably sized burst. Bursts are a low number of multiples of a unit timeslot, and bursts of different size can be fitted to the unit grid by concatenating unit timeslots to larger timeslots that can hold larger bursts. This concatenation may be done just in time.
- The modulation and coding to be used in a timeslot can be selected independently, allowing per timeslot ACM for more granular and more flexible link adaptation. The adaptation for a timeslot may be done just in time.
- Power headroom reporting is included. The power control system supports an optional control mode aiming for constant power spectrum density over carriers of different BW as an alternative to control the EIRP.

Version 1.4.1 of this document provides support for signalling about non-geosynchronous satellites (non-GSO) and about forward links using Annex E (superframes) of DVB-S2X [16], used by multibeam satellites, for interference suppression, pre-coding and beam-hopping. Additional signalling relevant for beam-hopping systems has also been added.

The present document allows substantial configuration flexibility in that the burst constructions and FEC can be adapted to some extent to the operating environment of the RCST. In order to guide in implementation and interoperability a set of reference burst configurations are specified, and the essential configuration space for such configuration is also indicated.

Clause 2 provides the references. Clause 3 provides the definitions of terms, explains symbols and expands abbreviations. Clause 4 provides further guiding in the reading of the present document through the introduction of reference models. Clause 5 specifies the forward link. Clause 6 specifies the syntax and coding of the lower layer signalling system components used in the forward link. Clause 7 specifies the return link. Clause 8 specifies the syntax and coding of the lower layer signalling system components used in the return link. Clause 9 specifies the management and control functions supported via the network internal L2S system. Clause 10 is reserved for future specification of the operation of mobile terminals. Clause 11 addresses security. Annex A provides the normative reference burst constructions. Annex B provides the CC-CPM interleaver permutations in tabular form. Annex C provides the CPM pulse shape specification in tabular form. Annex D provides the bibliography list.

1 Scope

The present document is a specification of the lower layers and the lower layer signalling system for the two-way satellite network variants defined by ETSI TS 101 545-3 [i.16]. The present document constitutes a complete specification of the lower layers for a transparent star satellite network, a transparent mesh overlay satellite network and a regenerative re-multiplexing satellite network. Also, components required for a satellite network with a TRANSEC system are included.

The present document is normative for the consumer terminal profile in a transparent star satellite network as defined by ETSI TS 101 545-3 [i.16], and does also include normative components specific to the other terminal profiles and satellite network variants defined by ETSI TS 101 545-3 [i.16].

2 References

2.1 Normative references

References are either specific (identified by date of publication and/or edition number or version number) or non-specific. For specific references, only the cited version applies. For non-specific references, the latest version of the referenced document (including any amendments) applies.

Referenced documents which are not found to be publicly available in the expected location might be found at <https://docbox.etsi.org/Reference/>.

NOTE: While any hyperlinks included in this clause were valid at the time of publication, ETSI cannot guarantee their long term validity.

The following referenced documents are necessary for the application of the present document.

- [1] ETSI EN 301 790: "Digital Video Broadcasting (DVB); Interaction channel for satellite distribution systems".
- [2] ETSI EN 302 307-1: "Digital Video Broadcasting (DVB); Second generation framing structure, channel coding and modulation systems for Broadcasting, Interactive Services, News Gathering and other broadband satellite applications; Part 1: DVB-S2".
- [3] ETSI EN 300 468: "Digital Video Broadcasting (DVB); Specification for Service Information (SI) in DVB systems".
- [4] ETSI EN 301 192: "Digital Video Broadcasting (DVB); DVB specification for data broadcasting".
- [5] ETSI EN 301 459: "Satellite Earth Stations and Systems (SES); Harmonized EN for Satellite Interactive Terminals (SIT) and Satellite User Terminals (SUT) transmitting towards satellites in geostationary orbit in the 29,5 to 30,0 GHz frequency bands covering essential requirements under article 3.2 of the R&TTE Directive".
- [6] ISO/IEC 13818-1:2013: "Information technology -- Generic coding of moving pictures and associated audio information -- Part 1: Systems".
- [7] IEEE 802.3™: "IEEE Standard for Ethernet".
- [8] ETSI TS 102 606: "Digital Video Broadcasting (DVB); Generic Stream Encapsulation (GSE)".
- [9] IETF RFC 3819: "Advice for Internet Subnetwork Designers".
- [10] ETSI TS 101 162: "Digital Video Broadcasting (DVB); Allocation of identifiers and codes for Digital Video Broadcasting (DVB) systems".
- [11] IETF RFC 1112: "Host Extensions for IP Multicasting".
- [12] IETF RFC 791 (1981): "Internet Protocol".

- [13] IETF RFC 2464 (1998): "Transmission of IPv6 Packets over Ethernet Networks".
- [14] ANSI/IEEE 754™ (1985): "IEEE Standard for Binary Floating-Point Arithmetic".
- [15] ETSI TS 102 472: "Digital Video Broadcasting (DVB); IP Datacast over DVB-H: Content Delivery Protocols".
- [16] ETSI EN 302 307-2: "Digital Video Broadcasting (DVB); Second generation framing structure, channel coding and modulation systems for Broadcasting, Interactive Services, News Gathering and other broadband satellite applications; Part 2: DVB-S2 Extensions (DVB-S2X)".

2.2 Informative references

References are either specific (identified by date of publication and/or edition number or version number) or non-specific. For specific references, only the cited version applies. For non-specific references, the latest version of the referenced document (including any amendments) applies.

NOTE: While any hyperlinks included in this clause were valid at the time of publication, ETSI cannot guarantee their long term validity.

The following referenced documents are not necessary for the application of the present document but they assist the user with regard to a particular subject area.

- [i.1] ETSI TR 101 790 (V1.4.1): "Digital Video Broadcasting (DVB); Interaction channel for Satellite Distribution Systems; Guidelines for the use of EN 301 790".
- [i.2] ETSI TR 101 202: "Digital Video Broadcasting (DVB); Implementation guidelines for Data Broadcasting".
- [i.3] ETSI TS 102 602: "Satellite Earth Stations and Systems (SES); Broadband Satellite Multimedia; Connection Control Protocol (C2P) for DVB-RCS; Specifications".
- [i.4] ETSI ETS 300 802: "Digital Video Broadcasting (DVB); Network-independent protocols for DVB interactive services".
- [i.5] IETF RFC 5163 (2008): "Extension Formats for Unidirectional Lightweight Encapsulation (ULE) and the Generic Stream Encapsulation (GSE)".
- [i.6] IEEE 802.1Q™ (2005): "IEEE Standard for Local and Metropolitan Area Networks - Virtual Bridged Local Area Networks Revision".
- [i.7] IEEE 802.1X™ (2010): "IEEE Standard for Local and metropolitan area networks - Port-Based Network Access Control".
- [i.8] IETF RCF 4326 (2005): "Unidirectional Lightweight Encapsulation (ULE) for Transmission of IP Datagrams over an MPEG-2 Transport Stream (TS)".
- [i.9] IETF RCF 3095 (2005): "RObust Header Compression (ROHC): Framework and four profiles: RTP, UDP, ESP, and uncompressed".
- [i.10] IETF RCF 826 (1982): "Ethernet Address Resolution Protocol: Or Converting Network Protocol Addresses to 48.bit Ethernet Address for Transmission on Ethernet Hardware".
- [i.11] IETF RCF 3643 (2003): "Fibre Channel (FC) Frame Encapsulation".
- [i.12] IETF RCF 2516 (1999): "A Method for Transmitting PPP Over Ethernet (PPPoE)".
- [i.13] IETF RCF 3032 (2001): "MPLS Label Stack Encoding".
- [i.14] IEEE 802.1ad-2005™: "IEEE Standard for Local and Metropolitan Area Networks - Virtual Bridged Local Area Networks - Revision - Amendment 4: Provider Bridges".
- [i.15] ETSI TS 101 545-1: "Digital Video Broadcasting (DVB); Second Generation DVB Interactive Satellite System (DVB-RCS2); Part 1: Overview and System Level specification".

- [i.16] ETSI TS 101 545-3: "Digital Video Broadcasting (DVB); Second Generation DVB Interactive Satellite System (DVB-RCS2); Part 3: Higher Layers Satellite Specification".
 - [i.17] ETSI TR 101 154: "Digital Video Broadcasting (DVB); Implementation guidelines for the use of MPEG-2 Systems, Video and Audio in satellite, cable and terrestrial broadcasting applications".
 - [i.18] National Imagery and Mapping Agency (NIMA) Technical Report TR8350.2: "Department of Defense World Geodetic System 1984".
 - [i.19] Directive 1999/5/EC of the European Parliament and of the Council of 9 March 1999 on radio equipment and telecommunications terminal equipment and the mutual recognition of their conformity (R&TTE Directive).
 - [i.20] Recommendation ITU-R M.1643: "Technical and operational requirements for aircraft earth stations of aeronautical mobile-satellite service including those using fixed-satellite service network transponders in the band 14-14.5 GHz (Earth-to-space)".
 - [i.21] IANA: "Unidirectional Lightweight Encapsulation (ULE) Next-Header Registry".
- NOTE: Available at <http://www.iana.org/assignments/ule-next-headers/>.
- [i.22] ETSI EN 302 186: "Satellite Earth Stations and Systems (SES); Harmonised Standard for satellite mobile Aircraft Earth Stations (AESs) operating in the 11/12/14 GHz frequency bands covering the essential requirements of article 3.2 of the Directive 2014/53/EU".
 - [i.23] ETSI EN 302 340: "Satellite Earth Stations and Systems (SES); Harmonized EN for satellite Earth Stations on board Vessels (ESVs) operating in the 11/12/14 GHz frequency bands allocated to the Fixed Satellite Service (FSS) covering essential requirements under article 3.2 of the R&TTE Directive".
 - [i.24] ETSI EN 302 448: "Satellite Earth Stations and Systems (SES); Harmonised Standard for tracking Earth Stations on Trains (ESTs) operating in the 14/12 GHz frequency bands covering the essential requirements of article 3.2 of the Directive 2014/53/EU".
 - [i.25] ETSI EN 302 977: "Satellite Earth Stations and Systems (SES); Harmonised Standard for Vehicle-Mounted Earth Stations (VMES) operating in the 14/12 GHz frequency bands covering the essential requirements of article 3.2 of the Directive 2014/53/EU".
 - [i.26] FCC Part 25-Satellite Communications, § 25.222: "Blanket Licensing provisions for Earth Stations on Vessels (ESVs) receiving in the 10.95-11.2 GHz (space-to-Earth), 11.45-11.7 GHz (space-to-Earth), 11.7-12.2 GHz (space-to-Earth) frequency bands and transmitting in the 14.0-14.5 GHz (Earth-to-space) frequency band, operating with Geostationary Satellites in the Fixed-Satellite Service".
 - [i.27] ETSI TR 101 545-4: "Digital Video Broadcasting (DVB); Second Generation DVB Interactive Satellite System (DVB-RCS2); Part 4: Guidelines for Implementation and Use of EN 301 545-2".
 - [i.28] ETSI EN 303 978: "Satellite Earth Stations and Systems (SES); Harmonized EN for Earth Stations on Mobile Platforms (ESOMP) transmitting towards satellites in geostationary orbit in the 27,5 GHz to 30,0 GHz frequency bands covering the essential requirements of article 3.2 of the R&TTE Directive".
 - [i.29] ITU Radio Regulations.

3 Definition of terms, symbols and abbreviations

3.1 Terms

For the purposes of the present document, the following terms apply:

addressed link protocol data unit: MAC PDU that transports one link PDU

allocation channel: specific transmission channel association of a timeslot as assigned by the NCC, may be used for dedicated access and random access

assignment identifier: identifier used to indicate the association of a timeslot to the access method and possibly a specific RCST as well as a specific channel for that RCST

cell fragment: areas on earth that are associated with none, one or multiple satellite delivery systems. Cell fragments can be static or have a slowly varying location.

connection control protocol: layer 1-4 connection control protocol specified in ETSI TS 102 602 [i.3] supporting regenerative networking and mesh overlay networking based on ETSI EN 301 790 [1]

contention access: See random access.

continuous phase modulation: non-linear modulation in which the carrier phase is modulated in a continuous manner

NOTE: CPM is typically implemented as a constant-envelope waveform, i.e. the transmitted carrier power is constant.

dedicated access: media access method by which each RCST is assigned dedicated resources for transmission

DVB-S2(X): DVB-S2 or DVB-S2X

dynamic RA load control: random access load control scheme operated by the RCST according to dynamic load controlling feedback received from the NCC

feeder: transmits the forward link signal, which is a standard satellite digital video broadcast (DVB-S, DVB-S2 or DVB-S2X) uplink, onto which are multiplexed the user data and/or the control and timing signals needed for the operation of the Satellite Interactive Network

forward link: satellite link from the NCC and feeder to the RCSTs

frame protocol data unit: MAC PDU that fills the payload of one frame and contains one or more payload adapted PDUs

gateway: entity that receives the RCST return link signals, and provides the next-hop bi-directional network-layer interface for traffic sent using a star connection

higher layer: set of protocols that are defined in the Higher Layer Specification, ETSI TR 101 154 [i.17]

hybrid transparent satellite network: network implemented partly as a transparent star satellite network and partly as a mesh overlay transparent satellite network

implementation dependent: feature or data field which implementation or significance depends on the implemented support

interactive network: segment of a network that supports two-way communication and is a single administrative entity

least margin transmission mode: transmission mode (as given by modulation, coding, pilots and frame size) providing the lowest link margin without violating the loss probability requirements and the required system specific margins to the loss probability sensitivity threshold of the transmission mode

left bit first: bit ordering concept for a bit sequence referring to the textual representation of the binary value in a field of contiguous bits

linear modulation: modulation in which the amplitude of the modulation envelope (or the deviation from the resting frequency) is directly proportional to the amplitude of the intelligence signal at all modulation frequencies

link protocol data unit: LLC PDU that transports one SDU

lower layer: layer 1 and layer 2 of the OSI stack

Lower Layer Signalling (L2S): internal M&C signalling that does not use standard intermediate layer protocols

medium access control address: address used to identify one or more terminations of a physical medium with more than one possible termination or origination of a transmission

medium access control service: set of supported request classes and other resource provisioning constituting the layer 2 service provided to the RCST

mesh link: satellite link from an RCST to another RCST, possibly connecting an RCST with the NCC in a system operated without a feeder

mesh overlay network: RCS network not involving a Gateway and Feeder in the user plane signal transport, but using single hop satellite connections between RCSTs

mobile terminal: RCST implementing the mobile terminal profile

multicast: communication capability, which denotes unidirectional distribution from a single source access point to one or more destinations without replication of the content on the link

NCR count value: parameter comprising a base field of up to 33 bits and a 9 bit extension field. Where the number of bits is less than the full 42 bit NCR format, the least significant 9 bits corresponds to the extension field and the remaining bits corresponds to the least significant bits of the base field

network: entity that supports communication and is a single administrative entity

network control centre: centralized entity terminating the internal management and control in a part of the satellite network

packet stream: sequence of packets

payload-adapted protocol data unit: MAC PDU that fits into a portion of the payload of the physical layer frame payload and contains either part of the information for one link PDU or all information for a link PDU

random access: media access method by which several transmitters may concurrently access the same portion of the resources

RCS-MAC: layer 2 address used to address packets to a specific entity at an RCST or to multicast traffic to a group of entities connected to the link

RCST Hardware Identifier: 48 bit address uniquely identifying an RCST, based on the vendor OUI in the same way as an IEEE 802.3 [7]

regenerative satellite network: network implemented by a satellite that intercepts and re-broadcasts the signal, processing at burst or packet level including demodulation and re-modulation of the signal

request class: capacity requests representing a specific traffic aggregate in the resource control signalling from the RCST to the NCC

resource controller: entity in the NCC that controls the distribution of the transmission resources

return link: satellite link from the RCSTs to the gateway

satellite delivery system: satellite physical medium by which one or more DVB transport streams are transmitted

satellite interactive network: interactive network that supports two-way satellite communication

satellite network: network that supports satellite communication

satellite virtual network: segment of the satellite network appearing as the total satellite network for the higher layer protocols

satellite virtual network number: number that identifies one of the satellite virtual networks

service aggregate: higher layer traffic aggregate that is mapped to and serviced by a lower layer service

service data unit: PDU offered to the lower layer for transport to the peer

single precision floating-point: 32-bit value representation format in accordance with IEEE 754 [14]

stationary RA load control: random access load control scheme operated autonomously by the RCST, i.e. without dynamic feedback from the NCC

superframe sequence: portion of frequency bandwidth of the return link, not necessarily contiguous, constituted by a consecutive sequence of superframes of a dedicated superframe type

system dependent: feature or data field which implementation or significance depends on the actual system implementation

transmission format class: transmission formats that share some distinguishing characteristics separating transmission formats of a class from all other transmission formats

transparent mesh overlay satellite network: network using a satellite that forwards the received signals transparently by a frequency shift (virtually no processing at burst or link level such as demodulation and decoding), with a mesh overlay network forwarding user plane satellite traffic in one satellite hop from one termination to another without passing the feeder/gateway, in addition to the communication supported by the transparent star satellite network

transparent star satellite network: network using a satellite that forwards the received signals transparently by a frequency shift (virtually no processing at burst or packet level such as demodulation and decoding), with all satellite traffic forwarded between a feeder/gateway and other terminations and no traffic directly between the other terminations

TS Packet Stream: generalization of the Transport Stream defined by ISO/IEC 13818-1 [6] including as well TS packets carried by a DVB-S2(X) packetized generic stream as defined by ETSI EN 302 307-1 [2]

unicast: communication capability, which denotes unidirectional distribution from a single source access point to a single specified destination access points (RCST or Gateway) (from HLS doc)

user defined: feature or data field which implementation or interpretation is chosen by the user

Virtual LAN (VLAN): defines a method of differentiating and separating traffic on a LAN by tagging the Ethernet frames (from HLS doc)

NOTE: Term specified by IEEE 802.1Q [i.6].

3.2 Symbols

For the purposes of the present document, the following symbols apply:

α	Roll-off factor
A, B	Input sequences to the turbo encoder
C_1	Circulation state of the turbo encoder in the natural order
C_2	Circulation state of the turbo encoder in the interleaved order
E_b/N_0	Ratio between the energy per information bit and single sided noise power spectral density
E_s/N_0	Ratio between the energy per transmitted symbol and single sided noise power spectral density
f_0	Carrier frequency
f_N	Nyquist frequency
H(f)	Raised Cosine filters frequency transfer function
I, Q	In-phase, Quadrature phase components of the modulated signal
K/N	GSPC code rate
N_b	GSPC sub-blocks number
$N_{R,max}$	Number of replicas in a frame
Nrand	12-bit random number used as a random seed value during CRDSA frame decoding
N_{slots}	Number of the slots in the frame
$P_1, P_2, \dots, P_{N_{R,max}}$	Vector that contains the $N_{R,max}$ indices of the slots containing the burst replicas
$P_{d_{j-1}}, \dots, P_0$	GSPC code parity bits
R, k/n	Burst code rate
R_s	Symbol rate corresponding to the bilateral Nyquist bandwidth of the modulated signal
S	State of the turbo encoder
S_x	Symbol
T_s	Symbol period
u_x	Bits

X	GSPC code information word
X(D)	GSPC code information polynomial
x_{K-1}, \dots, x_0	GSPC code information bits
Z ₁	Output sequence of the puncturing for the encoder in the natural order
Z ₂	Output sequence of the puncturing for the encoder in the interleaved order

3.3 Abbreviations

For the purposes of the present document, the following abbreviations apply:

16QAM	16-ary QAM
8PSK	8-ary PSK
ACI	Adjacent Channel Interference
ACM	Adaptive Coding and Modulation
ACQ	ACQuisition burst
ADT	Application Data Table
AF	Assured Forwarding
ALPDU	Addressed Link PDU
ARP	Address Resolution Protocol
ASCII	American Standard Code for Information Interchange
ATM	Asynchronous Transfer Mode
AVBDC	Absolute VBDC
BBFRAME	BaseBand FRAME
BCD	Binary Coded Decimal
BCT	RL Broadcast Configuration Table
BPSK	Binary PSK
bslbf	bit string, left bit first
BTP	Burst Time Plan
BTU	Bandwidth-Time Unit
BW	Bandwidth
CB	Control Burst
CC	Convolutional Coding or Continuous Carrier
CCM	Constant Coding and Modulation
CLI	Command Line Interface
CMD	Correction Message Descriptor
CMF	Control and Monitoring Functions
CMT	Correction Message Table
CNI	Carrier to Noise plus Interference ratio
CPM	Continuous Phase Modulation (or Modulator)
CRA	Constant Rate Assignment
CRC	Cyclic Redundancy Check
CRDSA	Contention Resolution DSA
CRSC	Circular Recursive Systematic Convolutional (code)
CSC	Common Signalling Channel
CW	Continuous Wave
DA	Dedicated Access
DCP	Dynamic Connectivity Protocol
DFL	Data Field Length
DHCP	Dynamic Host Control Protocol
DNS	Domain Name Server
DSA	Diversity Slotted Aloha
DSCP	Differentiated Services Code Point
DVB	Digital Video Broadcasting
EAP	Extensible Authentication Protocol
EIRP	Effective Isotropic Radiated Power
EPD	Extension Protocol Descriptor
ESI	Encoding Symbol Id
FAT	Fast Access Table
FCA	Free Capacity Assignment

FCT2	Frame Configuration Table 2
FDT	FEC Data Table
FEC	Forward Error Correction
FL	Forward Link
flagmsf	flag-field, most significant first
FLS	Forward Link Signalling
FPDU	Frame PDU
FS	Fixed Service
FSS	Fixed Satellite Service
GID	Group ID
GS	Generic Stream
GSE	Generic Stream Encapsulation
GSO	Geo- Synchronous Orbit
GSPC	Generic Sub-block Polynomial Code
GW	Gateway
HID	Hardware Identifier
HL	Higher Layer
HLS	Higher Layer Specifications
HW	HardWare
ID	Identifier
IDU	InDoor Unit
INID	Interactive Network ID
IP	Internet Protocol
ISI	Input Stream Identifier
ISS	Interactive Satellite System
L2S	Lower Layer Signalling
LAN	Local Area Network
LB	Logon Burst
LFSR	Linear Feedback Shift Register
LID	Logon ID
LL	Link Layer
LLC	Logical Link Control
LM	Linear Modulation (or Modulator)
LMMR	Least Margin Modcod Request
LPDU	Link PDU
LSB	Least Significant Bit
LT	Label Type
M&C	Management and Control
MAC	Media Access Control
MAC24	A 24 bit MAC address
MAC48	A 48 bit MAC address
MATYPE	Mode Adaptation TYPE
MF-TDMA	Multi-Frequency TDMA
MMT2	Multicast Mapping Table 2
MPE	Multi-Protocol Encapsulation
MPEG	Moving Pictures Expert Group
MPLS	Multi-Protocol Label Switching
MSB	Most Significant Bit
MSD	Mesh System Descriptor
MTU	Maximum Transmission Unit
NCC	Network Control Centre
NCR	Network Clock Reference
ncvmsbf	NCR count value, most significant bit first
NG	New Generation
NIT	Network Information Table
NLOS	Non Line Of Sight
NOC	Network Operations Center
ONID	Original Network ID
OSI	Open Systems for Interconnection
OUI	Organizationally Unique Identifier
PAM	Pulse Amplitude Modulation
PAT	Program Association Table

PCR	Program Clock Reference
PDU	Protocol Data Unit
PEP	Performance Enhancing Proxy
PHY	Physical Layer
PID	Packet Identifier
PL	Physical Layer
PLR	Packet Loss Ratio
PMT	Program Map Table
POPID	POPulation ID
PPDU	Payload-adapted PDU
PPPoE	Point-to-Point Protocol over Ethernet
PRBS	Pseudo Random Binary Sequence
PRO	PROtection
PSI	Program Specific Information
PSK	Phase Shift Keying
QAM	Quadrature Amplitude Modulation
QoS	Quality of Service
QPSK	Quadrature Phase Shift Keying
R&TTE	Radio and Telecommunication Terminal Equipment
RA	Random Access
RAS	Radio Astronomy Service
RBDC	Rate Based Dynamic Capacity
RCS	Return Channel over Satellite
RCST	RCS Terminal
REC	RECTangular
RF	Radio Frequency
RL	Return Link
RLE	Return Link Encapsulation
RMT	RCS Map Table
ROHC	RObust Header Compression
rpchof	remainder polynomial coefficients, highest order first
RS	Reed-Solomon
RSDT	Reed-Solomon Data Table
RX	Receive
SA	Slotted Aloha
SATID	SATellite ID
SBN	Source Block Number
SC	Solicited Capacity
SCT	Superframe Composition Table
SDT	Service Description Table
SDU	Service Data Unit
SE	Start-flag End-flag
SF	Spreading Factor
SFS	SuperFrame Sequence
SHA	Secure Hash Algorithm
SI	Service Information
SNDU	SubNetwork Data Unit
SNMP	Simple Network Management Protocol
SNO	Satellite Network Operator
SNR	Signal to Noise Ratio
SOF	Start Of Frame
spfmsbf	single precision floating-point, most significant bit first
SPT	Satellite Position Table
SRS	Space Research Service
SVN	Satellite Virtual Network
SVNO	SVN Operator
SW	SoftWare
SYNC	SYNChronization
SYNCD	SYNC Distance
TBTP2	Terminal Burst Time Plan 2
TC	Turbo Coding
tcimsbf	two's complement integer, msb (sign) bit first

TDM	Time Division Multiplex
TDMA	Time Division Multiple Access
TDT	Time and Date Table
TIM	Terminal Information Message
TIM-B	Terminal Information Message Broadcast
TIM-U	Terminal Information Message Unicast
TMST2	Transmission Mode Support Table 2
TRANSEC	TRANSMission SECurity
TRF	TRAFic burst
TS	Transport Stream
TX	Transmit
UDP	User Datagram Protocol
uimsbf	unsigned integer most significant bit first
UPL	User Packet Length
UW	Unique Word
VBDC	Volume Based Dynamic Capacity
VCM	Variable Coding and Modulation
VLAN	Virtual Local Area Network
VL-SNR	Very Low - Signal to Noise Ratio

4 Two-way Satellite Interactive Satellite System models

4.0 Introduction

The present document specifies the implementation of the lower layers for Interactive Satellite Systems (ISS) as defined by ETSI TS 101 545-1 [i.15] as well as the Lower Layer Signalling (L2S) system implemented over dedicated lower layer channels.

4.1 Interactive Satellite System Reference Models

Interactive Satellite System reference models are found in ETSI TS 101 545-1 [i.15].

4.2 System Model

The system model is found in ETSI TS 101 545-1 [i.15]. The entities used throughout the present document are for convenience explained here as well.

The present document emphasizes the *transparent star satellite network* where all satellite traffic to and from the *Return Channel Satellite Terminals (RCSTs)* passes through a shared *feeder/gateway* and a *transparent satellite*. Two more satellite network topologies are supported by the present document - a *mesh overlay transparent satellite network* and a *regenerative re-multiplexing satellite network*.

A transparent star satellite network is typically constituted by one broadband *forward link* that carries a single TDM carrying user traffic, control traffic and management traffic, and a *return link* that is implemented over a number of carriers each used either for TDMA or TDM, carrying the same type of traffic as the forward link. Each forward link TDM is supported by a *feeder* and a large number of RCSTs may connect to the TDM provided by the feeder. All satellite traffic to the RCSTs is provided via the feeder and the forward link TDM. The return link is supported by a *gateway* closely connected with the feeder. All satellite transported traffic from the RCSTs are terminated by this gateway and forwarded to the appropriate feeder/gateway side entities.

The *Network Control Centre (NCC)* terminates the L2S management plane and the L2S control plane at the feeder/gateway side and the RCSTs terminate these planes for L2S at the remote side. The user plane is typically interconnected with external infrastructure via suitable equipment connected at the feeder/gateway side. One essential application of an Interactive Satellite System (ISS) is as an IP sub-network, and the user plane equipment is then IP routers and link equipment for transport of IP traffic.

4.3 Dynamic Connectivity

Refer to ETSI TS 101 545-1 [i.15] for a description of dynamic connectivity.

4.4 Reference Architectures

Refer to ETSI TS 101 545-1 [i.15] for a description of reference network architectures and reference terminal architectures.

4.5 Protocol Stack Model

For the interactive services supporting broadcast to the end user with return channel, a simple protocol stack model is used, consisting of the following layers:

Physical layer: part of the lower layers where the transmission parameters and transmission frame constructions are defined.

Data link layer: part of the lower layers that defines the logical link control and the medium access control protocols.

Intermediate layers: the higher layer protocols connecting to the lower layers.

Applications layer: the interactive application software and runtime environment (e.g. home shopping application, script interpreter, etc.).

Figure 4-1 separates the lower layers from the higher layers in this simplified model, and identifies some of the key elements for the lower two layers.

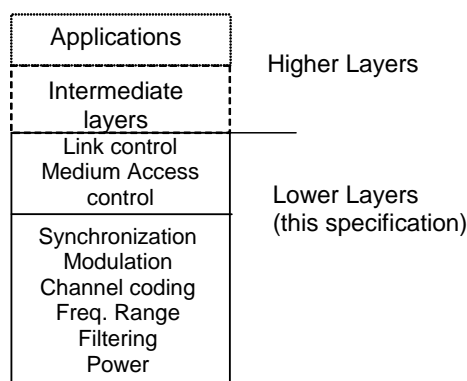

Figure 4-1: Identification of the Lower Layers

The present document addresses the lower layers. The present document covers also internal M&C functions that are not using intermediate layer protocols but are provided with exclusive channels in the lower layer protocol stack through L2S.

The generic intermediate and application layers are specified in ETSI TS 101 545-3 [i.16].

4.6 The Lower Layers

4.6.0 Introduction

Figure 4-2 illustrates, as seen from the RCST how the lower layers are structured with respect to L2S and with respect to higher layer traffic. Three types of layer 1 payload formats are defined for the return link - logon, control and traffic. The traffic payload format may carry both higher layer traffic and L2S. The logon payload format and the control payload format carry only L2S. Two types of layer 1 payload formats are defined for the forward link, one type for carrying L2S and another type for carrying higher layer traffic.

Four layer 1 content types are defined for the return link: logon, control, traffic and traffic/control. The logon and control content types are for L2S, the traffic content type is for higher layer traffic, and the traffic/control content type is for higher layer traffic and L2S, at RCST discretion.

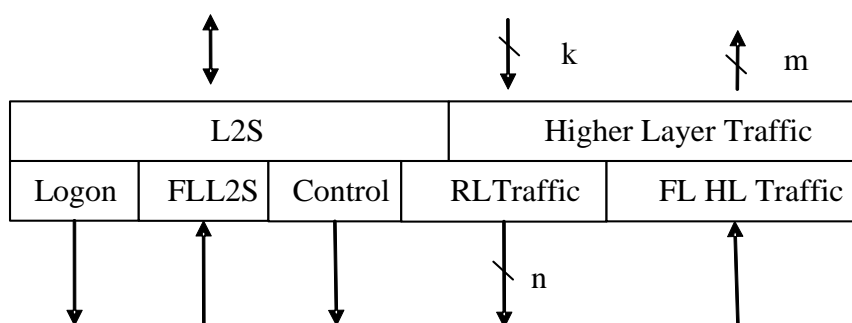

Figure 4-2: Segmentation of the Lower Layers at an RCST in a transparent star network

A higher layer PDU is considered a Service Data Unit (SDU) by the lower layers.

The transport used to reach the RCST from the feeder is specified in clause 5. The RCST lower layers may be configured to separate the received unicast satellite traffic into 'm' layer-2 virtual interfaces as described in clause 5.2.2. Received satellite multicast traffic may be separated similarly, as specified in clause 5.2.3. This lower layer separation into virtual interfaces may be used to separate the higher layer traffic into domains, allowing independent use of a higher layer protocol within each domain.

With reference to figure 4-2, the RCST may be assigned satellite transmission resources for 'n' layer-1 allocation channels useful for transmission of the traffic frames, as described in clauses 7.2.5, 7.2.6 and 7.2.7, specifying random access, dedicated access, and burst time plan, respectively. The resources may be utilized by any of the virtual interfaces. The lower layers may support transmission of 'k' layer-2 service aggregates mapped into the 'n' layer-1 allocation channels. There is a default mapping of the higher layer traffic. Non-default mapping is system dependent and has to be managed. Support for this management is specified in ETSI TS 101 545-3 [i.16].

4.6.1 Lower Layer Services

The mapping of an aggregate of SDUs into the satellite return link is illustrated in figure 4-3. The SDUs are reorganised as internal lower layer PDUs that fit precisely into the provisioned transmission frames (as frame PDUs), fragmenting the SDUs and possibly combining traffic from different service aggregates if allowed. The lower layers use out-of-band signalling to implement the return link lower layer services, using request classes and allocation channels. The configuration of the lower layer service associated to a service aggregate and its corresponding lower layer stream determines the allowed mapping of the associated lower layer PDUs to request classes for dynamically requesting for resource allocation, the allowed mapping to allocation channels for dedicated access and the allowed mapping to allocation channels for random access. Each lower layer service is at least configured with a nominal mapping to one allocation channel and may be allowed mapping to other allocation channels in addition. Each allocation channel is associated to a connectivity channel, which is associated with one or more receivers. The implicit connectivity channel is associated to a gateway receiver and the NCC. Other connectivity channels may be administratively configured and dedicated to other types of connectivity, but this is out of scope for the present document. The sequence of frames transmitted by the RCST constitutes the transmission channel.

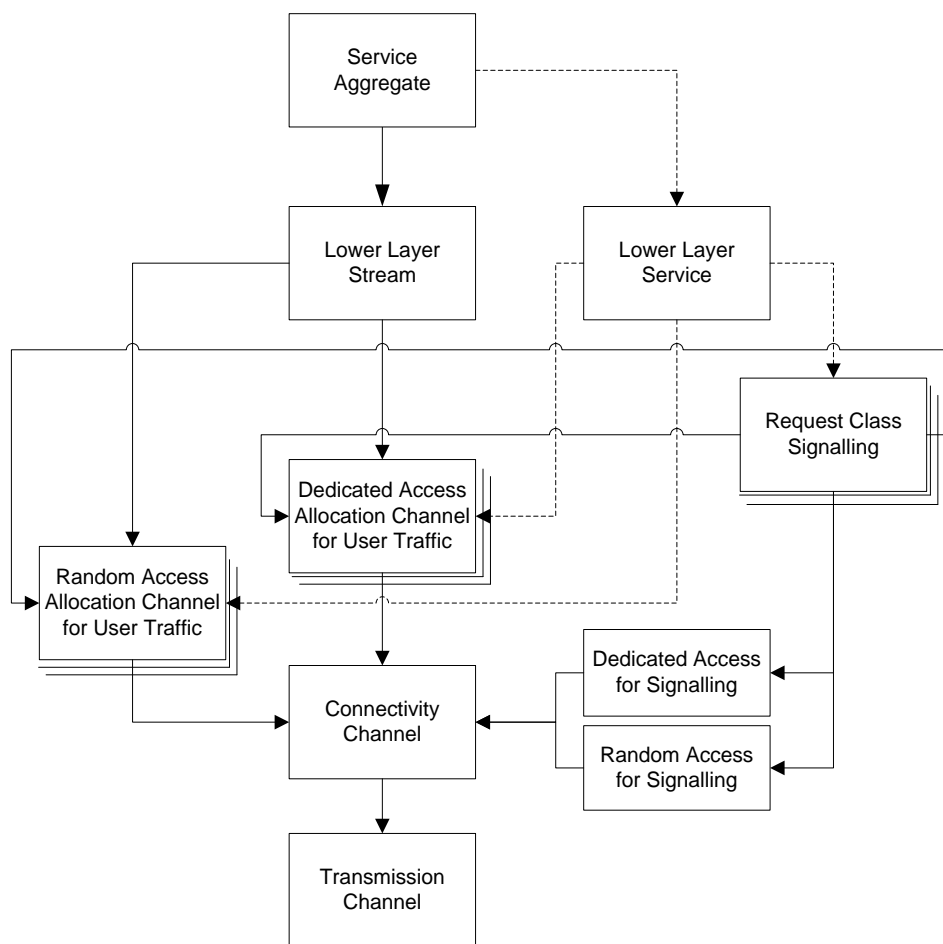

Figure 4-3: Mapping of a Service Aggregate in the Lower Layers

The interface for SDU transport for the return link is specified in clause 7.1.1. The higher layer PDUs are mapped into the transmission frames of the return link and addressed to the targeted receivers as specified in clauses 7.2.1 through 7.2.6. The discontinuous burst transmission of traffic frames is specified in clauses 7.3 through 7.5. An example of how a sequence of SDUs is mapped into a sequence of PDUs fitting into a sequence of transmission frame payloads is shown in figure 4-4.

Higher layers	SDU1	SDU2	SDU3
LLC	Link PDU 1	Link PDU 2	Link PDU 3
MAC	Addressed LPDU 1	Addressed LPDU 2	Addressed LPDU 3
	Payload adapted PDU 1	Payload adapted PDU 2	Payload adapted PDU 3
	Frame PDU 1	Frame PDU 2	
PHY	Transmission Frame 1	Transmission Frame 2	

Figure 4-4: An example of the mapping of a sequence of SDUs into transmission frames

The burst waveforms are specified in clause 7.3. Waveforms for continuous phase modulation are supported as specified in clauses 7.3.6.2 and 7.3.7.2. Waveforms for linear modulation are supported as specified in clauses 7.3.6.1 and 7.3.7.1. The set of burst waveforms is programmable as specified in clause 9.8. A set of reference waveforms is provided in annex A. Annex B provides interleaver permutations for CPM reference waveforms in tabular form, and annex C provides the CPM pulse shape in tabular form.

The RCST communicates with the NCC via L2S and sends configuration requests, receives configuration data, communicates control information, exchanges status information and requests for transmission resources. The management and control functions supported by L2S are specified in clause 9. The L2S are specified in clauses 6 and 8, respectively for the forward link and the return link. Clause 5 specifies the inclusion of L2S in the forward link multiplex. The transmission of L2S in the return link is specified in clause 7.

4.6.2 Lower Layer Interfaces

Figure 4-5 shows the forward link interfaces for an RCST that is configured with one layer 2 interface for user traffic. The present document allows an RCST to be implemented with several such layer 2 interfaces for user traffic, each interface capable of supporting a Satellite Virtual Network (SVN), in addition to the administrative layer 2 interface for the Satellite Network Operator (SNO). Each SVN is operated by an SVN Operator (SVNO). The feeder segregates between these domains by the mapping to layer 2 addresses.

The L2S is designed to take up the layer 1 and layer 2 interfaces and to initialize the IPv4 M&C interfaces to enable communication between the RCST, SNO and SVNO over IPv4. The RCST takes up the forward link L2S interface autonomously. The RCST shall have the necessary configuration for this in advance.

Specific configuration of the generic higher layer interface is out of scope for the present document, and is addressed by ETSI TS 101 545-3 [i.16].

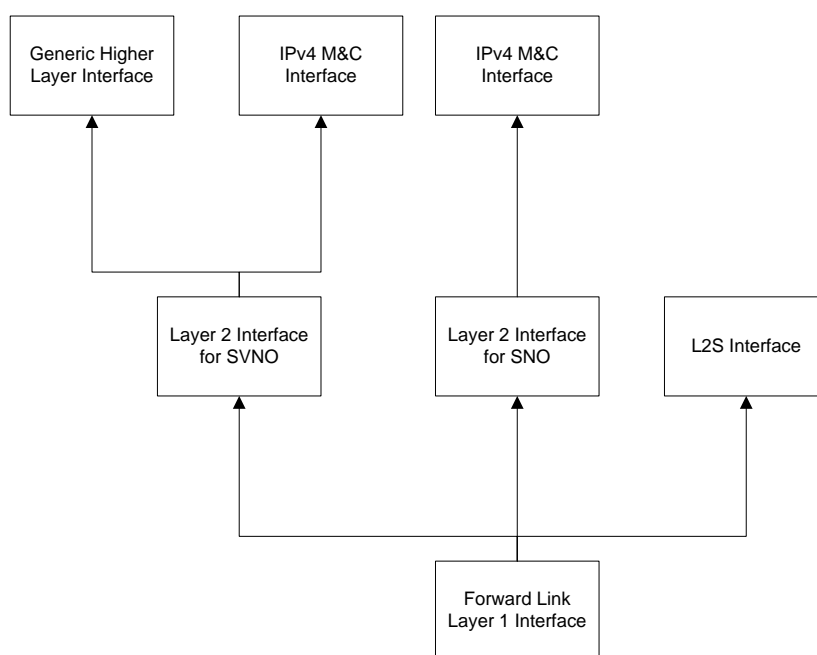

Figure 4-5: Forward Link Interfaces at an RCST

Figure 4-6 shows an example of return link interfaces for an RCST that is equipped as shown in figure 4-5 for the forward link. The L2S is designed to take up these return link interfaces. The NCC determines which of the allocation channels that are relevant and accessible for the different lower layer services and associated service aggregates. Each service aggregate as shown in figure 4-3 originates from a single layer 2 interface. A lower layer service as shown in figure 4-3 may however be shared by several service aggregates, possibly originating from different layer 2 interfaces.

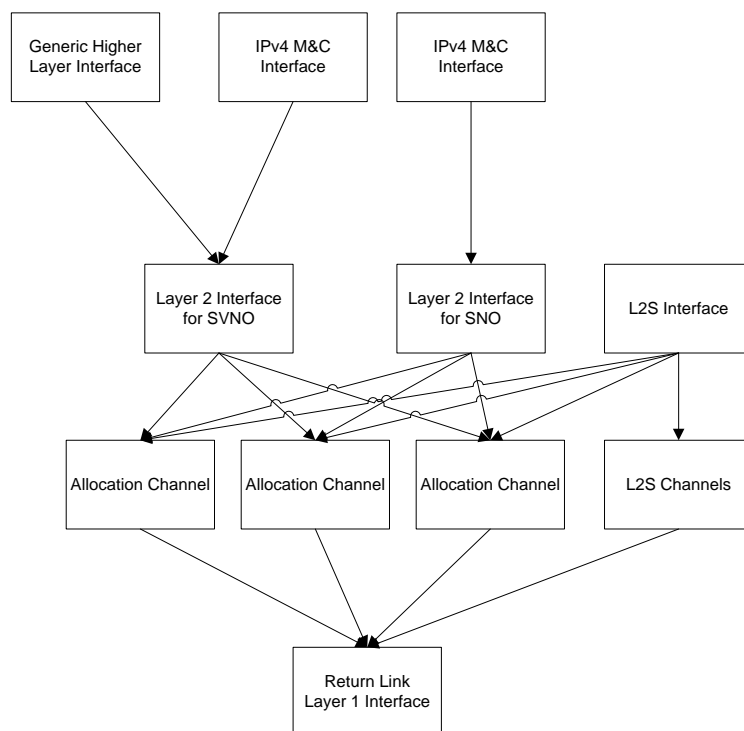

Figure 4-6: Return Link Interfaces at an RCST

The RCST needs to be connected to the feeder/gateway and NCC in order to have available the interfaces shown in figures 4-5 and 4-6. An RCST shall use the following sequence to establish these interfaces:

- a) At boot time, the RCST shall take up the L2S interface for the forward link autonomously, and acquire the broadcast L2S information necessary to access the gateway and the NCC. This is specified in clause 9.1.
- b) The RCST accesses the NCC via the gateway and requests the NCC to take up its layer 2 interfaces for two way communication, and also to initialize the IPv4 M&C interfaces, if required. This is specified in clause 9.2.
- c) The NCC assigns layer 2 addresses to the layer 2 interfaces, assigns and specifies return link services, assigns allocation channels to the services, and by this specifies the allowed mapping of the different services into the different allocation channels.
- d) The RCST is ready for forwarding user plane traffic when also the generic higher layer interface is properly configured. This may have been done in advance or may follow in sequence. The RCST indicates to the NCC at logon if it is fully commissioned.

L2S supports in taking up the interfaces as follows:

- a) A Logon Request, optionally indicating the MTU for the return link, and optionally indicating higher layer capabilities, specified in clause 8.2, used as specified in clause 9.2 and clauses 9.4.1 through 9.4.7.
- b) A Logon Response descriptor sent in TIM-U, specified in clause 6.4.17.18, used as specified in clause 9.4.8.
- c) A Lower Layer Service descriptor sent in TIM-U, specified in clause 6.4.17.17, used as specified in clause 9.4.9.
- d) Conditionally, a Higher Layers Initialization descriptor sent in TIM-U, specified in clause 6.4.17.28, used as specified in clause 9.4.10.
- e) Optionally, a DHCP Option descriptor with the MTU for the return link, sent in TIM-U or in TIM-B, specified in clause 6.4.17.19, used as specified in clause 9.13.

5 Forward Link and Regenerative Mesh Downlink

5.0 Introduction

The Forward Link supports uni-directional connection-less transport and multiplexing of different packet-based protocols. The lower layers specified in this clause receive SDUs from the higher layers for transport over the forward link and delivery to the corresponding higher layer entity at the peer.

The regenerated mesh downlink shares the lower layer specifications in this clause. RCST support of regenerated mesh downlink is an option.

NOTE: The "regenerated mesh downlink" is a downlink for regenerated mesh links, whereas the "forward link" is a downlink from the hub/NCC as seen by the RCST. A "forward link" is defined as the link from the hub/NCC feeder, which is part of the transparent ground system per definition. "Regenerative mesh downlink" refers specifically to the downlink part of mesh links in a regenerative system. "Forward link" refers specifically to the combination of uplink and downlink in a transparent system. Even if the downlink physical layer specification for a regenerative mesh RCST and a transparent star RCST is the same, control and management planes differ for these RCSTs.

5.1 SDU Transport in the Forward Link

5.1.0 Introduction

The SDU transport concerns essentially IP in addition to the internal lower layer signalling SDU and NCR SDU. Transport of PDUs for other protocols is feasible but not mandated by the present document. The present document recognizes the protocol types listed in table 5-1. Generally, the protocol type values above 0x600 reflect standard ethertypes used on wired connections and the lower values are used by header extension protocols. Some values from the lower range are as shown in the table overtaken by the present document to support indication of the RCS specific and system specific protocol types.

Table 5-1: Some Recognized SDU protocol types

Protocol Type value	Protocol description	Reference
0x0000	Test SNDU header extension	[i.8]
0x0001	Bridged-SNDU header extension	[i.8]
0x0002	TS-Concat header extension	[i.5]
0x0003	PDU-Concat header extension	[i.5]
0x00C8	LL_RCS_FEC_FDT header extension	[1]
0x0100	Extension-Padding	[i.8]
0x0200	Extension-Padding	[i.8]
0x0300	Extension-Padding	[i.8]
0x0301	Time-Stamp header extension	[i.5]
0x03C3	LL_CRC32 header extension	[1]
0x0400	Extension-Padding	[i.8]
0x04C2	LL_RCS_FEC_ADT header extension	[1]
0x0500	Extension-Padding	[i.8]
0x0800	IPv4	[12]
0x0806	ARP	[i.10]
0x8100	VLAN tagged frame	[i.6]
0x22F1	ROHC	[i.9]
0x86DD	IPv6	[13]
0x8809	Slow Protocols (IEEE 802.3)	[7]
0x8847	MPLS unicast	[i.13]
0x8848	MPLS multicast	[i.13]
0x8863	PPPoE Discovery Stage	[i.12]
0x8864	PPPoE Session Stage	[i.12]
0x888E	EAP over LAN	[i.7]
0x88A8	Q-in-Q (IEEE 802.1ad)	[i.14]
0x8906	Fibre Channel over Ethernet	[i.11]
0x9100	Q-in-Q	Legacy

Protocol Type value	Protocol description	Reference
0x0081	NCR	The present document
0x0082	Internal M&C signalling (L2S)	The present document
0x0083	Dynamic Connectivity Protocol	[i.16]
0x0084	Reserved	The present document
0x0085	TRANSEC system protocol	ref security in [i.15]
0x0086	Encrypted layer 2 payload	ref security in [i.15]
0x0087	Reserved	The present document
0x0088	Reserved	The present document

The TDM feeder should avoid or sufficiently limit use of a PDU of other protocol type than explicitly known to be supported by the addressed RCSTs. The SDU may be discarded by the RCSTs if the SDU is of a protocol type that the RCST does not support. The supported set of protocols may be an extended subset of the recognized set listed in table 5-1.

5.1.1 SDU Transport in GSE PDUs

5.1.1.0 Introduction

The SDUs shall be transported in GSE PDUs that comply with the GSE PDU specification in ETSI TS 102 606 [8] using a continuous generic stream as specified in ETSI EN 302 307-1 [2]. The SYNC byte of the BBFRAME header specified in ETSI EN 302 307-1 [2] is by ETSI TS 101 162 [10] reserved to identify the format and syntax used in the BBFRAME of a continuous generic stream. Thus, the SYNC byte value shall be used to indicate the specific BBFRAME format used for transport of the GSE PDUs.

The RCST shall support mixed use of GSE packet label suppression, 3 byte GSE packet label and 6 byte GSE packet label. GSE packet label re-use shall not be used.

5.1.1.1 Implicit Integrity Protection of SDU (optional)

ETSI TS 101 162 [10] reserves SYNC value 0x00 to indicate a BBFRAME carrying GSE PDUs in the way specified in ETSI TS 102 606 [8]. The RCST may support this method for transport of the GSE PDUs.

5.1.1.2 Explicit Integrity Protection of SDU

In order to satisfy the SDU transport integrity recommendations when transporting IP, as given in BCP89 (IETF RFC 3819 [9]), the RCST shall support a modified format and syntax of the BBFRAME data field for transport of the GSE PDUs. In this format a CRC is inserted within the data field of the BBFRAME. This shall be a CRC32 carried in the last four bytes of the data field, i.e. within the BBFRAME payload volume limited by the value of the DFL indicated for the BBFRAME. The CRC32 algorithm to be used is the same CRC32 calculation as specified for the SDU fragmentation protection used for GSE and specified in ETSI TS 102 606 [8]. The input to the CRC32 calculation is all the content of the data field (i.e. exclusive of the BBHEADER) except for the CRC32 field.

The SYNC value 0x01 shall be inserted in the BBFRAME header to indicate that the BBFRAME contains both GSE PDUs and the specified CRC at the end of the data field with a value calculated as specified in this clause.

5.1.1.3 Maximum Transfer Unit for an SDU in the Forward Link

The RCST support for forward link MTU shall be:

- a) 4 095 bytes for the internal lower layer signalling.
- b) 1 500 for the internal IPv4 M&C traffic.
- c) For other traffic either 1 500 bytes or as indicated by administrative means, if larger than 1 500 bytes.

5.1.2 SDU Transport in TS Packets (optional)

Refer to ETSI EN 301 790 [1] for the transport of SDUs over a TS packet stream.

5.2 Addressing in the forward link

5.2.0 Introduction

On the Forward Link, each layer 2 interface of each RCST, as well as single or multiple multicast groups are identified by unique MAC addresses. The MAC addresses for higher layer traffic are assigned by the NCC. The principle that a specific system employs to construct a consistent MAC address space is out of scope for the present document, except for the principles used for separation between SVNs.

5.2.1 Addressing of L2S

GSE packets for L2S broadcast signals shall omit the packet label, using LT="10" or 2 decimal. The packets are to be forwarded to the signalling entity of each RCST according to the implicit understanding of the destination and use of a protocol type indicating L2S.

GSE packets for L2S unicast signals shall use the 6 byte packet label (LT="00" or 0 decimal). This MAC48 address shall be the unique RCST HID stored in the non-volatile memory of the RCST. The RCST HID shall be constructed according to the specification for IEEE 802.3 [7] and shall thus consist of 48 bits, and is expected to include a registered Organizational Unit Identifier (OUI). The RCST HID shall be used to address L2S messages specific to one RCST. These packets are to be processed according to the protocol type indication.

When signalling via a TS Packet Stream, the unicast destination used by the lower layer control and management signalling protocol shall be the unique RCST HID. The value 0xFFFFFFFFFFFF shall be used as destination when broadcasting messages over TS targeting all RCSTs when using the same format as for individually addressed messages, as specified in ETSI EN 301 790 [1].

5.2.2 Addressing the Unicast Higher Layer Traffic

5.2.2.0 Introduction

Unicast SDU traffic is mapped to a unicast MAC address to reach one specific RCST.

The unicast MAC address differs for a continuous generic stream and a TS Packet Stream. The method for mapping a unicast SDU packet to a MAC address is out of scope for the present document, except for the option of providing the higher layer address for system internal M&C in the logon response as specified in clause 9.4.4. The mapping may be remotely managed as specified in ETSI TS 101 545-3 [i.16].

5.2.2.1 Addressing Unicast Sent with GSE

The RCST shall when connected to a continuous generic stream support addressing of unicast SDUs in the forward link by using the 3 byte GSE label (LT="01" or 1 decimal). An RCST shall accept unicast traffic addressed to the unicast MAC24 assigned to each of its layer 2 interfaces. The RCST shall support at least two layer 2 interfaces for higher layer traffic, where one shall be dedicated to internal M&C via higher layers, and this has SVN number '0'. The NCC will at logon provide the RCST with a unicast MAC24 address for each SVN that the RCST shall connect to, each MAC24 address made up of an SVN number prefix part and an SVN unique part for the RCST within the specific SVN. The RCST is assumed to support independent SDU processing for each of the supported SVNs as specified in ETSI TS 101 545-3 [i.16].

5.2.2.2 Addressing Unicast Sent over a TS Packet stream (optional)

The MAC48 address used for transporting a unicast SDU in MPE in a TS Packet stream shall be the 48 bit RCST HID as used in ETSI EN 301 790 [1]. This addressing scheme does not support SVN separation at the RCST side. When operating on a single TS Packet Stream the RCST shall implicitly assume this MAC48 address and shall thus accept user traffic and M&C traffic destined to its RCST HID.

5.2.3 Addressing the Multicast Higher Layer Traffic

5.2.3.0 Introduction

Multicast SDU traffic may be mapped to a unicast RCS-MAC or a multicast RCS-MAC to reach either one RCST or a group of RCSTs, respectively.

A multicast RCS-MAC is different for a continuous generic stream and a TS Packet Stream.

5.2.3.1 Addressing Multicast over GSE

There are two different schemes that may be used to support mapping of multicast addresses to RCS-MAC addresses for traffic over a continuous generic stream using GSE.

The NCC indicates to the RCST in the Logon Response Descriptor in TIM-U the multicast mapping scheme that the RCST shall use, for each user traffic SVN. The M&C SVN is not required to support multicast address mapping indicated via MMT2, but this shall be supported for each user traffic SVN.

The network layer multicast mapping to MAC24 is synthesized autonomously by the RCST as instructed in the Logon Response descriptor. This method uses the content of the 'unicast_mac24' as basis for the mcast MAC24. The n least significant bits (bits 0,...,(n-1)) of the MAC24 are replaced by the corresponding bits from the MAC address synthesis specified in IETF RFC 1112 [11] (or IETF RFC 2464 [13] for IPv6). The value of n is indicated in the Logon Response descriptor as 'mcast_synthesis_field_size'. Bit n is set to '1'. Bit n+1 is optionally used to distinguish between IPv4 multicast and IPv6 multicast, as indicated in the Logon Response descriptor. When bit n+1 is used this way, the value '1' indicates IPv6 and the value '0' indicates IPv4.

Alternatively, the multicast mapping may be managed via the MMT2. The MMT2 supports mapping also of other protocol types than IPv4 and IPv6. It supports synthesis in limited ranges and it supports exclusive mapping of a network layer multicast address to a MAC24. An MMT2 applies for all the SVNs that have the prefix in the SVN number as specified for this MMT2. Several MMT2s specified with different prefix sizes may apply for a given RCST.

5.2.3.2 Addressing Multicast over TS Packet stream

Reference ETSI EN 301 790 [1] specifies the address mapping to MAC48 used for multicast sent via a TS Packet stream. The mapping to optional supplemental elementary streams may be resolved as specified by ETSI TR 101 790 [i.1].

5.3 Layer 2 FEC (optional)

5.3.0 Introduction

Upper layer FEC mechanisms and/or lower layer FEC mechanisms can be applied for protection against channel impairments. Upper layer FEC mechanisms exist and are out of scope for the present document. Layer 2 FEC mechanisms can be implemented as specified in this clause.

Transmissions of multicast and unicast traffic data can be protected against channel impairments such as short interruptions and shadowing by the inclusion and processing of additional coding in accordance with the provisions of this clause. The technique employed is called Link Layer Forward Error Correction (LL-FEC). RCSTs that declare support for Non-Line-Of-Sight (NLOS) countermeasures shall be able to receive and process a forward link signal transmitted in accordance with these provisions. This technique may also be applied to the optional continuous return link carrier transmissions defined in clause 7.6.

LL-FEC is introduced to support reception in situations of high Packet Loss Ratio (PLR). Such high PLR may occur for example on mobile channels when the speed is too high and/or the signal-to-noise ratio is too low. It may also occur due to obstruction, blockage, or other situations in which the line of sight is interrupted. With the LL-FEC, a variable amount of capacity is allocated to parity overhead.

Transmissions employing LL-FEC use the same basic data structures as other transmissions. LL-FEC can use the Raptor code as specified in annex C of ETSI TS 102 472 [15] for LL-FEC frame ADT sizes up to 12 Mbytes or the MPE-FEC Reed-Solomon code as specified in clause 9.5.1 of ETSI EN 301 192 [4] with any LL-FEC frame ADT size up to 191 Kbytes. The chosen code is identified in the forward link signalling.

For the purpose of the present clause, the following definitions shall apply.

Datagram: A network layer (OSI-layer 3) data frame. In the case of Internet Protocol, a datagram is an IP datagram.

GSE-FEC Stream: A sequence of GSE packets with the same `gse_fec_id` identifier.

LL-FEC: Method to deliver parity data codes for datagrams delivered on GSE packets.

LL-FEC Frame: The collection of data and parity packets of one GSE-FEC stream with identical `fec_frame_number`.

LL-FEC Frame Application Data Table: The collection of data packets of one GSE-FEC stream with identical `fec_frame_number`. It also defines the mapping of the respective datagrams to the LL-FEC Frame.

LL-FEC Frame FEC Data Table: The collection of parity packets of one GSE-FEC stream with identical `fec_frame_number`. It also defines the generation of parity symbols for the LL-FEC Frame.

Receiver: The receiver is an entity within an RCST, consisting of Radio Frequency front-end, channel decoding and demultiplexing. Input to a Receiver is an RF signal, and the output is Network layer datagrams.

5.3.1 LL-FEC Frame

5.3.1.0 Introduction

The LL-FEC frame is a conceptual construction used to generate LL-FEC parity sections from a sequence of layer 3 datagrams. It is composed of the ADT and the FDT. The LL-FEC frame shall conceptually be arranged as a matrix with a flexible number of columns for both the ADT and the FDT. The maximum number for `no_adt_columns` and `no_fdt_columns` depend on the type of code used. The `no_adt_columns` is signalled in each parity section/packet transmitted along with this LL-FEC frame. The `no_fdt_columns` is not explicitly signalled for Raptor, but is signalled for the Reed-Solomon code. The matrix has a flexible number of rows with a maximum that depends on the type of code used. Figure 5-1 shows the conceptual organization of the frame.

The number of rows is signalled in the LL-FEC identifier descriptor (clause 6.4.17.13). Each position in the matrix can hold an information byte. The left part of the LL-FEC Frame is used for OSI layer 3 (Network layer) datagrams (e.g. IP datagrams) and possible padding, and is called the Application Data Table (ADT). The right part of the LL-FEC Frame is dedicated for the parity information of the FEC code and is called the FEC Data Table (FDT). The number of columns in the ADT and FDT can vary frame-by-frame.

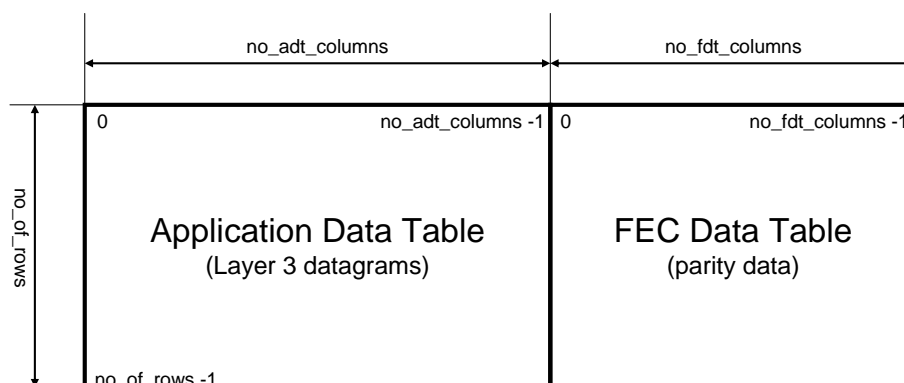

Figure 5-1: LL-FEC frame

5.3.1.1 Filling of Application Data Table

Layer 3 datagrams shall be inserted consecutively, starting with the first byte of the first datagram in the upper left corner of the ADT matrix; going downwards in the first column and wrapping to the next column when the last row in a column has been filled. The length of the datagrams may vary.

Insertion of the datagrams depends on the addressing granularity, which is signalled implicitly through the `frame_size` parameter in the LL-FEC identifier descriptor (see clause 6.4.17.13). The process is illustrated in figure 5-2.

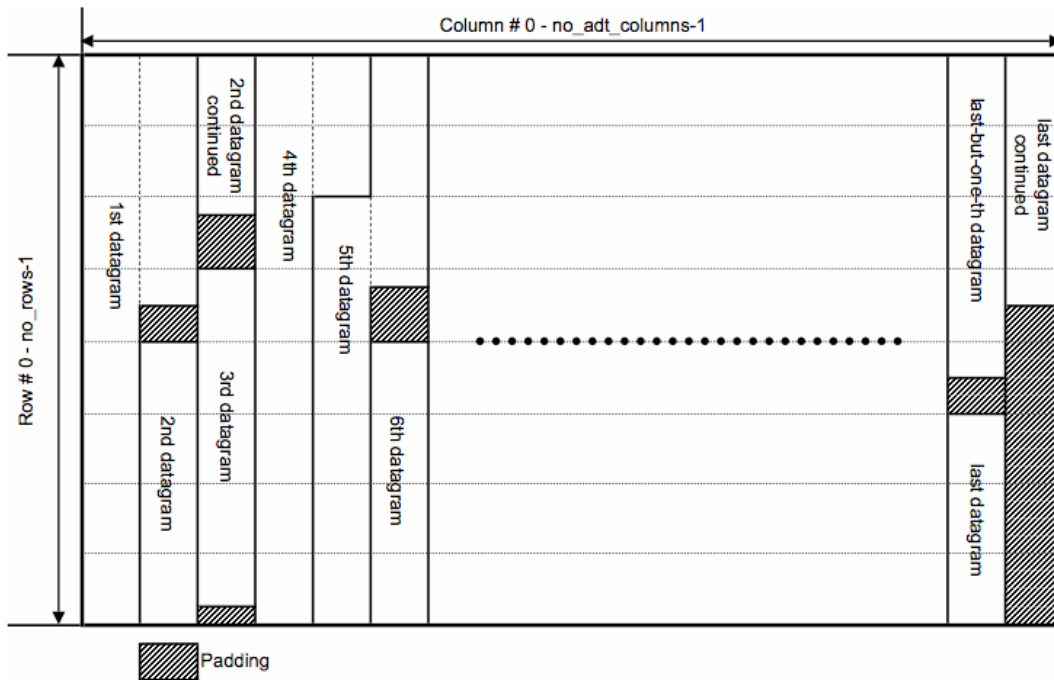

Figure 5-2: Application data table

Each layer 3 datagram shall be assigned a unique address within the LL-FEC ADT table. Zero-padding bytes are inserted, if necessary, in the last column of the ADT to fill the column completely. The last column shall contain at least one byte of a layer 3 datagram.

For addressing granularity equal to 1, datagrams are inserted in the ADT consecutively and without any padding.

When the addressing granularity is greater than 1, each layer 3 datagram is inserted in the ADT as follows: its first byte shall be inserted at the next ADT address which is an integer multiple of the address granularity. Any bytes between the last byte of the previous layer 3 datagram and the first byte of the new layer 3 datagram in the ADT shall be filled with zeros. Each layer 3 datagram gets assigned a unique address within the LL-FEC ADT table such that the address is an integer multiple of the address granularity.

Signalling of parameters associated with each individual datagram is defined in clause 5.3.2.3.

5.3.1.2 Generation of the FEC Data Table

5.3.1.2.0 Introduction

Once the ADT is filled, parity data columns for the FDT can be computed by applying the selected coding technique. The decision on the completeness of an ADT table is implementation and/or system specific and not within the scope of the present document. It may depend on latency consideration, the LL-FEC code rate and other parameters. However, the transmitter shall ensure that the difference in time between the transmission of the first and last packets within a given LL-FEC frame does not exceed the `buffer_timeout` signalled in the LL-FEC identifier descriptor.

5.3.1.2.1 Reed-Solomon Code

The Reed-Solomon code shall be that specified in clause 9.5.1 of ETSI EN 301 192 [4]. The maximum `no_adt_columns` in this case is 191 and the maximum `no_fdt_columns` is 64. In case `no_adt_columns` is less than 191, the ADT shall be extended with `191-adt_columns` zero columns and code shortening as specified in clause 9.3.3.1 of ETSI EN 301 192 [4] shall be applied. In case `no_fdt_columns` is less than 64, the last `64-no_fdt_columns` shall be punctured as specified in clause 9.3.3.2 of ETSI EN 301 192 [4].

The LL-FEC frame shall be constructed in the same manner as the MPE-FEC frame defined in clause 9.3.1 of ETSI EN 301 192 [4]. The correspondence between the MPE-FEC frame elements of ETSI EN 301 192 [4] and the LL-FEC Frame elements is the following:

- The FDT is equivalent to Reed-Solomon Data Table (RSDT) defined in ETSI EN 301 192 [4].
- Time-slicing as defined in ETSI EN 301 192 [4] shall not be used.

For the purpose of carriage of Reed-Solomon code parity data in GSE packets, the real-time parameters defined in clause 9.10 of ETSI EN 301 192 [4] shall be mapped to the RCS real-time parameter block used for LL-FEC as defined in table 5-2. The RCS real-time parameter block is defined in clause 5.3.2.3.

Table 5-2: Mapping of real time parameters between MPE-FEC and LL-FEC

MPE-FEC (clause 9.10 of ETSI EN 301 192 [4])	LL-FEC (clause 5.3.2.3)	Comments
delta_t (5 lsb)	fec_frame_number	Only 5 lsb carried in LL-FEC
delta_t (7 msb)	-	7 msb not carried in LL-FEC
table_boundary	table_boundary	
frame_boundary	-	Not carried in LL-FEC
address	dt_position (18 lsb)	18 bits mapped into the dt_position lsb's
-	dt_position (2 msb)	Bits set to "00"

5.3.1.2.2 Raptor Code

The systematic Raptor encoding procedure in ETSI TS 102 472 [15], clause C.4 shall be applied. The maximum no_adt_columns in this case is 8 192 and the maximum no_fdt_columns is 65 536-no_adt_columns. The encoding procedure shall be applied in such a way that the ADT with no_adt_columns corresponds to the source block with no_adt_columns source symbols and each column of the ADT corresponds to a source symbol. In case no_adt_columns is less than 4, the ADT column shall be extended with 4-adt_columns zero columns and code shortening as specified in clause 9.3.3.1 of ETSI EN 301 192 [4] shall be applied.

The FDT is defined as the consecutive encoding symbols of the Raptor codes, whereby the first FDT column corresponds to the encoding symbol ID (ESI) no_adt_columns. Each row of the FDT thus contains exactly one Raptor symbol. The sub-blocking option specified in ETSI TS 102 472 [15] shall not be applied.

The number of FDT columns shall be at most 65 536 minus the number of ADT columns.

NOTE 1: Raptor symbols that are not transmitted need not be generated; therefore, puncturing is generally not necessary. The no_fdt_columns is not signalled to the receiver.

NOTE 2: For each LL-FEC frame at the receiver, the decoder needs:

- The number of ADT columns, no_adt_columns for this FEC frame which corresponds to the Raptor source block size as long as no_adt_columns \geq 4. Note that no_adt_columns may change for every LL-FEC frame.
- The Source Block Number (SBN), equivalent to the fec_frame_number.
- In addition, the decoder needs for each received encoding symbol the encoding symbol id (ESI). The mapping of the ESI signalling to the Raptor parity data is specified in clause 5.3.2.2.

5.3.2 Carriage of LL-FEC Frames

5.3.2.0 Introduction

This clause defines provisions for carriage of Layer 3 datagrams and the LL-FEC frame FDT columns in Generic Streams. The GSE packets carrying the Layer 3 datagrams and the FDT columns from the same LL-FEC Frame shall be carried in one GSE-FEC stream. Each GSE packet carried within this GSE-FEC stream shall be marked with the same gse_fec_id identifier as specified in the corresponding LL-FEC identifier descriptor. The gse_fec_id shall be carried in the LL-FEC extension header specified in clause 5.3.2.1.1.

The `ll_fec_identifier_descriptor` (clause 6.4.17.13) shall be used to signal information about LL-FEC for GSE streams. The `encapsulation_type` flag in the `ll_fec_identifier_descriptor` shall be set to "1". Encapsulation of applications data and parity data into GSE PDUs shall be in accordance with ETSI TS 102 606 [8].

5.3.2.1 Carriage of Application Data

5.3.2.1.0 Introduction

The following provisions apply to each GSE-FEC stream for which the `ll_fec_identifier_descriptor` indicates that LL-FEC is used:

- The application data packets shall be encapsulated in accordance with ETSI TS 102 606 [8]. There shall be no padding between applications data; i.e. any padding inserted for the purpose of computation of parity data shall be removed prior to transmission. datagrams shall not overlap in the Application Data Table.
- Real-time parameters and identification of the LL-FEC process shall be carried in an optional extension header as defined in clause 5.3.2.1.1.
- Each LL-FEC Frame shall only contain complete datagrams (i.e. datagrams shall not be fragmented between LL-FEC Frames).
- For each LL-FEC Frame, at least one GSE packet carrying application data shall be delivered.
- The first packet carrying data of a given LL-FEC Frame shall be the GSE packet carrying the Application data datagram at address "0".
- All packets carrying Application data datagrams of a given LL-FEC Frame shall be transmitted prior to the first packet carrying parity data of the LL-FEC Frame (i.e. packets carrying Application data datagrams shall not be interleaved with packets carrying parity data within a single LL-FEC frame).
- Within a GSE-FEC stream, all packets carried between the first and the last packet of an LL-FEC Frame shall carry the data belonging to the LL-FEC Frame (i.e. only GSE packets carrying datagrams and LL-FEC packets carrying parity data are allowed).
- Within a GSE-FEC stream, packets delivering data of different LL-FEC Frames shall not be interleaved.
- When the layer 3 datagram needs to be divided over multiple GSE packets, the optional extension header as defined in clause 5.3.2.1.1 shall be carried only in the GSE packet carrying the first datagram fragment and shall indicate the `dt_position` in the Application data table of the first byte of the datagram.
- Additional reliability information for the reception process may be obtained by applying the NLOS adaptation optional extension header defined in clause 5.3.2.1.2.

5.3.2.1.1 GSE-FEC application data optional header extension

The GSE optional extension header for carrying application data shall be referred to as `LL_RCS_FEC_ADT` and is defined in table 5-3.

Table 5-3: GSE optional header extension for carrying application data

Syntax	No. of bits	Identifier
<code>LL_RCS_FEC_ADT () {</code>		
Reserved	2	bslbf
gse_fec_id	14	uimsbf
reserved_for_future_use	6	bslbf
rcs_real_time_parameters ()	26	See semantics
<code>}</code>		

Semantics for `LL_RCS_FEC_ADT`:

- reserved: Shall be set to "11";

- `gse_fec_id`: This 14-bit field shall refer to a LL-FEC Frame that has been defined with a LL-FEC identifier descriptor using the same `gse_fec_id` value, assuming that `stream_type` field in the descriptor has been set to '1'. This field shall be used to differentiate the GSE-FEC streams by their corresponding LL-FEC Frame. It can also be used for filtering;
- `reserved_for_future_use`: This 6-bit field shall be set to "111111";
- `rce_real_time_parameters`: This 26-bit field carries real-time parameters for the application data. The details are specified in clause 5.3.2.3.

The presence of an optional extension header is defined by using an invalid `protocol_type` with a value lower than 0x600. The `protocol_type` field can either be in the main GSE header or after an optional header as specified in ETSI TS 102 606 [8]. The 16-bit optional header type field carried in the `protocol_type` field is formed as defined in table 5-4.

Table 5-4: GSE optional header extension type definition

Syntax	No. of bits	Identifier
<code>optional_extension_header_type () {</code>		
<code>start_indicator</code>	5	bslbf
<code>header_length</code>	3	bslbf
<code>optional_header_type</code>	8	uimsbf
<code>}</code>		

Semantics for `optional_extension_header_type`:

- `start_indicator`: This 5-bit field shall be set to a value of '00000';
- `header_length`: This 3-bit field specifies the length of the optional header, which allows receivers ignorant of certain optional header type to skip the header and still be able to decode the GSE payload. This shall be set to '100', indicating a 6-byte header length as defined in ETSI TS 102 606 [8];
- `optional_header_type`: This 8-bit field uniquely identifies this optional extension header; its value shall be as defined in IANA [i.21].

5.3.2.1.2 NLOS Adaptation optional header extension

The optional extension header defined in this clause may be used for LL-FEC frames carried over GSE-FEC streams. Its purpose is to improve performance. This extension header shall be referred to as `LL_CRC32` and is described in table 5-5. This extension header may be used only in GSE packets carrying a non-fragmented layer 3 datagram.

Table 5-5: GSE CRC-32 optional header extension

Syntax	No. of bits	Identifier
<code>LL_CRC32 () {</code>		
<code>CRC_32</code>	32	rpchof
<code>}</code>		

The `CRC_32` field shall be computed over all bytes starting from the GSE Length field (included) to the end of the GSE packet, but not including the CRC extension header fields. The computation method shall otherwise be equivalent to that defined in clause 4.2.2 of ETSI TS 102 606 [8].

The header type definition for the `LL_CRC32` shall use the syntax defined in table 5-4, with the following semantics:

- `start_indicator`: This 5-bit field shall be set to a value of '00000';
- `header_length`: This 3-bit field specifies the length of the optional header, which allows receivers ignorant of certain optional header type to skip the header and still be able to decode the GSE payload. This shall be set to '011', indicating a 4-byte header length as defined in ETSI TS 102 606 [8];
- `optional_header_type`: This 8-bit field uniquely identifies this optional extension header; its value shall be as defined in IANA [i.21].

5.3.2.2 Carriage of Parity Data

Parity data and associated real-time parameters shall be carried in GSE packets as defined in this clause. This packet format defines a mandatory extension header. This header shall be referred to as LL_RCS_FEC_FDT.

NOTE 1: The use of a mandatory extension header ensures that receivers that do not support LL-FEC will discard the entire packet, in accordance with ETSI TS 102 606 [8].

Padding shall not exist between delivered parity data in the parity data table.

When carrying raptor Code parity data, each PDU shall carry exactly one repair symbol or group of repair symbols, i.e. one FDT column or a group of several consecutive FDT columns.

When carrying Reed-Solomon parity data, each PDU shall carry one FDT column.

The packet format shall be in accordance with table 5-6.

NOTE 2: The ll_fec meta-variable is not carried explicitly in this packet. The pertinent value is defined in the LL_FEC_identifier_descriptor entry (clause 6.4.17.13) that applies to the LL-FEC data being transported.

Table 5-6: GSE GSE packet format for parity data

Syntax	No. of bits		Information Mnemonic
	Reserved	Information	
GSE_packet () {			
start_indicator		1	bslbf
end_indicator		1	bslbf
label_type_indicator		2	bslbf
gse_length		12	uimsbf
if ((start_indicator == '0') OR (end_indicator == '0')) {			
frag_id		8	uimsbf
}			
if ((start_indicator == '1') AND (end_indicator == '0')) {			
total_length		16	uimsbf
}			
if (start_indicator == '1') {			
protocol_type		16	uimsbf
gse_fec_id	2	14	uimsbf
reserved_for_future_use	6		bslbf
if (ll_fec == '01') {			
padding_columns		8	uimsbf
column_number		8	uimsbf
last_column_number		8	uimsbf
rcs_real_time_parameters()		26	See semantics
}			
else {			
no_adt_columns	3	13	uimsbf
encoding_symbol_id		16	uimsbf
fec_frame_number	13	5	uimsbf
}			
}			
for (i=0; i<N; i++) {			
parity_data_byte		8	bslbf
}			
if ((start_indicator == '1') AND (end_indicator == '1')) {			
parity_data_crc_32		32	rpchof
}			
if ((start_indicator == '0') AND (end_indicator == '1')) {			
crc_32			
}			
}			

Semantics for LL_RCS_FEC_FDT:

- start_indicator: This field shall be interpreted as defined in ETSI TS 102 606 [8];

- end_indicator: This field shall be interpreted as defined in ETSI TS 102 606 [8];
- label_type_indicator: This is a 2-bit field. It shall be set to "10" to indicate that no label field is present;
- gse_length: This field shall be interpreted as defined in ETSI TS 102 606 [8];
- frag_id: This field shall be interpreted as defined in ETSI TS 102 606 [8];
- total_length: This field shall be interpreted as defined in ETSI TS 102 606 [8];
- protocol_type: This 16-bit field shall indicate the presence of a LL_RCS_FEC_FDT mandatory extension. As defined in ETSI TR 101 790 [i.1], the 8 MSB shall be set to '0000 0000' and the 8 LSB, corresponding to the header type field, shall uniquely identify this mandatory extension header. The value of this field shall be as defined in IANA [i.21];
- gse_fec_id: This 14-bit field shall refer to a LL-FEC Frame that has been defined with a LL-FEC identifier descriptor using the same gse_fec_id value, assuming that encapsulation_type field in the descriptor has been set to '1'. This field shall be used to differentiate the GSE-FEC streams by their corresponding LL-FEC Frame. It can also be used for filtering;
- reserved_for_future_use: These six bits shall be set to '111111';
- padding_columns: This 8-bit field indicates the number of full columns of the Application data table of the actual LL-FEC Frame filled with padding bytes only; i.e. it is equal to 191 minus the number of columns that contain Application data. The value indicated shall be from 0 to 190. The value may vary frame by frame;
- column_number: This 8-bit field gives the number of the FDT column containing the RS data. The column_number of the first column carrying RS data of an LL-FEC Frame shall be 0x00. The column_number shall be incremented by 1 with each additional column containing RS data of the concerned LL-FEC Frame;
- last_column_number: This 8-bit field shall indicate the number of the last FDT column that contains RS data of the current LL-FEC Frame;
- rcs_real_time_parameters: This 26-bit field carries RCS Real-time parameters for the FEC parity data. The details are specified in clause 5.3.2.3;
- no_adt_columns: This 13-bit field indicates the number of columns of the Application data table of the actual FEC Frame. The value indicated shall be from 0 to 8191. The value may vary frame by frame;
- encoding_symbol_id: This 16-bit field specifies the ESI of the first encoding symbol of this section. The ESI shall be greater than or equal to no_adt_columns for the LL-FEC Frame;
- fec_frame_number: This field shall be interpreted as defined in clause 5.3.2.3;
- parity_data_byte: These bytes contain the parity data;
- parity_data_crc_32: This 32-bit field shall be computed over all bytes starting from the GSE length field (included) to the end of the GSE packet, but not including the CRC field. The computation method shall be equivalent to that defined in clause 4.2.2 of ETSI TS 102 606 [8];
- crc_32: This field shall be interpreted as defined in ETSI TS 102 606 [8].

5.3.2.3 Real-Time Parameters

Real-time parameters describing the properties of LL-FEC tables shall be formatted in accordance with table 5-7.

Table 5-7: Real-time parameters

Syntax	No. of bits	Identifier
rsc_real_time_parameters () {		
table_boundary	1	bslbf
fec_frame_number	5	bslbf
dt_position	20	bslbf
}		

Semantics for rcs_real_time_parameters:

- **table_boundary:** This 1-bit flag, when set to "1", indicates that the current packet is the last packet of a table within the current LL-FEC Frame.

NOTE: A decoder not supporting MPE-FEC may ignore all subsequent packets until the end of the LL-FEC Frame. The **table_boundary** may also be used to ignore any upcoming LL-FEC parity data in case no loss has been detected in the LL-FEC Frame ADT. Finally, the **table-boundary** can be used by receivers to insert padding in the last column of the LL-FEC Frame ADT.

- **fec_frame_number:** The field supports a cyclic LL-FEC Frame index within the elementary stream. The value of the field increases by one for each subsequent LL-FEC Frame. After value "11111", the field restarts from "00000". This field can be used to resolve ambiguities resulting from long sequences of lost data.
- **dt_position:** This 20-bit field specifies the position in the corresponding LL-FEC Frame table of the first byte of the payload carried within the packet. In case the layer 3 datagram is fragmented over multiple packets, each packet indicates the **dt_position** in the Application data table of the first byte of the datagram fragment carried within the packet. All packets delivering data for any LL-FEC Frame table shall be delivered in ascending order according to the value of this field. The **dt_position** is derived by dividing the address by the address granularity.

The byte position is a zero-based linear address within an LL-FEC Frame ADT, starting from the first row of the first column, and increasing towards the end of the column. At the end of the column, the next byte position is at the first row of the next column.

For each LL-FEC Frame, exactly one packet shall be transmitted with **dt_position** field set to value "0".

For each LL-FEC Frame for which RS parity data is transmitted as specified in clause 5.3.1.2.1, exactly one LL-FEC section shall be transmitted with **dt_position** field set to value "0".

For each LL-FEC Frame for which Raptor parity data is transmitted as specified in clause 5.3.1.2.2, the **dt_position** field shall be a reserved field and shall be set to "0xFFFFF".

5.4 DVB-S2(X) Physical Layer

5.4.0 Introduction

The RCST shall be able to receive digital signals conforming to ETSI EN 302 307-1 [2], ETSI EN 302 307-2 [16], ETSI TR 101 202 [i.2], ETSI ETS 300 802 [i.4], ETSI EN 300 468 [3], ETSI EN 301 192 [4] and ETSI TR 101 154 [i.17], as applicable.

With reference to DVB-S2 specified profiles, one of the two profiles defined in ETSI EN 302 307-1 [2] may be used, the broadcast profile using Constant Coding and Modulation (CCM) or the interactive profile using Adaptive Coding and Modulation (ACM).

With reference to the DVB-S2X specified profiles, one of the following profiles defined in ETSI EN 302 307-2 [16] may be used: Interactive services or VL-SNR.

The RCST shall support the RCS specific DVB-S2 profile defined in ETSI TS 101 545-1 [i.15].

5.4.1 DVB-S2 CCM operation

Concerning the use of continuous generic stream for transport, a CCM TDM is utilized the same way as an ACM TDM operating on a single MODCOD. The use of MODCOD requests and the declaration of supported transmission modes in TMST2 are both optional in the CCM case.

Refer to ETSI EN 301 790 [1] with respect to the use of TS Packets for transport.

5.4.2 DVB-S2 and DVB-S2X ACM operation

5.4.2.1 ACM TDM carrying TS packets (optional)

Refer to ETSI EN 301 790 [1] for transport of TS packets over a DVB-S2(X) TDM using ACM.

5.4.2.2 Single stream ACM TDM carrying GSE PDU

A TDM with a single continuous generic stream may be set up as shown in table 5-8.

Table 5-8: BBFRAME header parameters for a single continuous generic stream

Application area/ Configuration	MATYPE-1	MATYPE-2	UPL	DFL	SYNC	SYNCD	CRC-8	Slicing policy
RCS service; VCM/ACM; Continuous GS	01-1-0-0-0-YY	X	-	K_{bch}	0x01	-	-	-
YY => Roll-off, according to configuration/computation; X => do not care; K_{bch} => according to PL frame type.								

5.4.2.3 Multi-stream ACM TDM carrying GSE PDU (optional)

A TDM with multiple continuous generic streams may be set up as shown in table 5-9.

Table 5-9: BBFRAME header parameters for multiple continuous generic streams

Application area/ Configuration	MATYPE-1	MATYPE-2	UPL	DFL	SYNC	SYNCD	CRC-8	Slicing policy
RCS service; VCM/ACM; Continuous GS	01-0-0-0-0-YY	X1	-	K_{bch}	0x01	-	-	-
RCS service; VCM/ACM; Continuous GS	01-0-0-0-0-YY	Xn	-	K_{bch}	0x01	-	-	-
YY => Roll-off, according to configuration/computation; X => do not care; K_{bch} => according to PL frame type; ISI in X1, Xn in accordance with ISI values assigned to the different RCSTs.								

5.4.2.4 Transmission mode usage

An RCST can only be expected to receive the transmission modes indicated in the TMST2 and at the transmission modes for each stream as indicated in the TMST2. Thus, traffic to an RCST shall not be issued using other transmission modes than those indicated being used for each specific stream.

A TDM using ACM should not contain traffic to an RCST issued at a higher transmission mode than requested by the RCST, given that the provided a transmission mode request signal has been received by the NCC. The feeder shall stop using a specific transmission mode towards an RCST 400 ms after indication has been received from the RCST that it cannot receive transmissions in this mode. The TDM may contain traffic to the RCST at any of the transmission modes currently indicated supported by the RCST, i.e. limited by the intersection of the TMST2 specification and the TDM signal quality report received or the least margin transmission mode request.

5.4.2.5 PL frame usage

An RCST shall support these variants of PL frame usage in a TDM, within the span of supported transmission modes:

- Short PL frames alone.
- Short PL frames mixed with dummy PL frames.
- Normal (also known as Long) PL frames alone.
- Normal (also known as Long) PL frames mixed with dummy PL frames.
- A mix of short, medium and normal PL frames and dummy PL frames, if the RCST is supporting the DVB-S2X VL-SNR profile.

Any of the above transmission modes embedded within superframes, as described in Annex E of [16] if the RCST supports a Superframe format option.

An RCST should be capable of receiving any mix of normal PL frames, short PL frames and dummy PL frames without dropping packets.

5.4.2.6 SYNC Byte Usage

When operating a continuous generic stream the SYNC byte in the BBFRAME header is reserved by ETSI TS 101 162 [10] to indicate the content of the BBFRAME payload. ETSI TS 101 162 [10] allows a range of the values for private use. The present document reserves a portion of the private use range for internal use, as specified in table 5-10.

Table 5-10: Utilization of SYNC Values

Value	Utilization
0x00 to 0xB8	Reserved by ETSI TS 101 162 [10]
0xB9	User private TRANSEC encrypted BBFRAME content
0xBA	User private TRANSEC encrypted BBFRAME content with NCR header
0xBB-0xCF	Reserved for future use by the present document
0xD0 to 0xFF	User Private

5.4.3 FL Modulation and Coding

The support of FL modulation and coding may vary between different types of RCST implementations as specified in ETSI TS 101 545-1 [i.15].

5.4.4 Symbol Scrambling

5.4.4.0 Introduction

A DVB-S2(X) forward link may according to ETSI EN 302 307-1 [2] and ETSI EN 302 307-2 [16] be implemented with use of one out of a set of symbol scrambling sequences.

5.4.4.1 Broadcast Type Symbol Scrambling

An RCST shall support connection to a forward link using the symbol scrambling sequence '0' as mandated for broadcasting by ETSI EN 302 307-1 [2] and ETSI EN 302 307-2 [16].

5.4.4.2 Custom Type Symbol Scrambling (optional)

An RCST may support connection to a forward link using other symbol scrambling sequences than '0' as specified by ETSI EN 302 307-1 [2] and ETSI EN 302 307-2 [16]. This is implementation dependent.

5.4.4.3 Two-way Symbol Scrambling

If the RCST supports an option of the list below, it shall support connection to a forward link using two-way scrambling composed of payload symbol scrambling and reference symbol scrambling sequences as specified by ETSI EN 302 307-2 [16] Annex E:

- Fixed Size Super-frame
- Beam Hopping Periodic BH, VLSNR(Superframe Format 5)
- Traffic driven BH VLSNR (Superframe Format 6)
- Traffic driven BH, no VL-SNR (Superframe Format 7)

5.4.5 Direct Sequence Spread Spectrum (optional)

A number of techniques that can be used for spread-spectrum operation of the forward link are described in ETSI TR 101 545-4 [i.27].

6 Forward Link L2S

6.0 Introduction

The forward link reserves some of the protocol types for the L2S. DVB defines a set of tables built upon the MPEG PSI tables to provide detailed information regarding the broadcast network over TS Packet stream. Such DVB tables are referred to as the Service Information (SI) tables. In a two-way satellite Interactive Network, consisting of a forward link via satellite and a return link via satellite, medium access control information and other signalling are communicated through the forward link and shall be transmitted in a DVB compliant manner when sent over a TS. Thus, the specifications for Service Information (SI) in DVB systems shall apply as specified in ETSI EN 300 468 [3]. The TS based forward link signalling consists of general SI tables, carrying information about the structure of the satellite interactive network, and RCST specific messages sent to individual RCSTs, private data fields defined for standard DVB-SI tables, special Transport Stream packets (PCR Insertion) and descriptors, including private descriptors for standard DVB-SI tables.

The present document provides the means to transport the content of these SI tables over one or more continuous generic streams as well as means to transport the RCS specific signalling over such a stream. As this type of stream does not adhere to the TS concept, TS specific identifiers used in the standard tables are replaced by more generic identifiers. The encapsulation protocol used on the continuous generic stream is defined in [8].

The signalling system may as an alternative to transport over a TS compliant with ISO/IEC 13818-1 [6] be transported over a packetized continuous stream configured to transport the equally sized TS packets as specified in ETSI EN 302 307-1 [2].

6.1 Protocol Stack

Figure 6-1 gives an overview of the protocol stack for the lower layer signalling in a continuous generic stream based forward link.

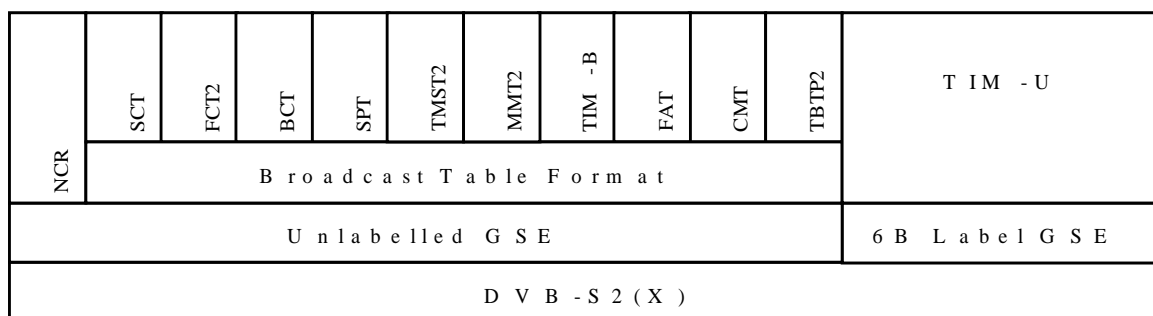

Figure 6-1: Protocol Stack for Lower Layer Signalling over a Continuous Generic Stream Forward Link

The protocol stack for the lower layer signalling in a TS Packet based forward link is as specified in ETSI EN 301 790 [1]. The signalling tables specified in the present document and required signalled on the TS Packet based forward link are using table format variants that makes the table structure compliant with ETSI EN 301 790 [1] through the methods specified in the present document.

6.2 Forward Link L2S Components

6.2.0 Introduction

The PDUs carrying L2S signals are identified by dedicated protocol types.

6.2.1 Network Clock Reference Indication

6.2.1.0 Introduction

Constraints are imposed on the RCST to allow the NCC to maintain an efficient MF-TDMA system with minimum interference between users and maximum throughput. For this reason, the synchronization scheme is based on information contained within the Forward Link Signalling as follows:

- broadcast NCR (Network Clock Reference);
- regular adjustments in the RCST transmission timing to maintain sufficient alignment with the MF-TDMA structure.

NCR broadcast is supported over a continuous generic stream as well as over a TS Packet stream by use of different transport format.

6.2.1.1 NCR in Continuous GS

The first method (NCRv1) specified in this clause shall be used when broadcasting NCR over a continuous generic stream, for DVB-S2 ACM TDM, DVB-S2 CCM TDM as well as DVB-S2X TDM (when NCRv1 is selected in the Satellite Forward Link Descriptor). The second method (NCRv2) shall be used when broadcasting NCR over a continuous generic stream for DVB-S2X TDM when NCRv2 is selected in the Satellite Forward Link Descriptor.

The NCR is distributed within the stream (identified by ISI) that carries the Forward Link Signalling.

To construct a local reference NCR the RCST shall associate the received NCR value with the submission time of a forward link timing reference symbol as issued at the return link satellite position. The first symbol of the Start-Of-Frame field of the Nth DVB-S2(X) physical layer frame serves as the reference symbol for an NCR packet where the most significant bit of the NCR packet is carried in the (N+2)th DVB-S2(X) physical layer frame.

The offset of 2 frames accommodates the encoding time in the forward link equipment.

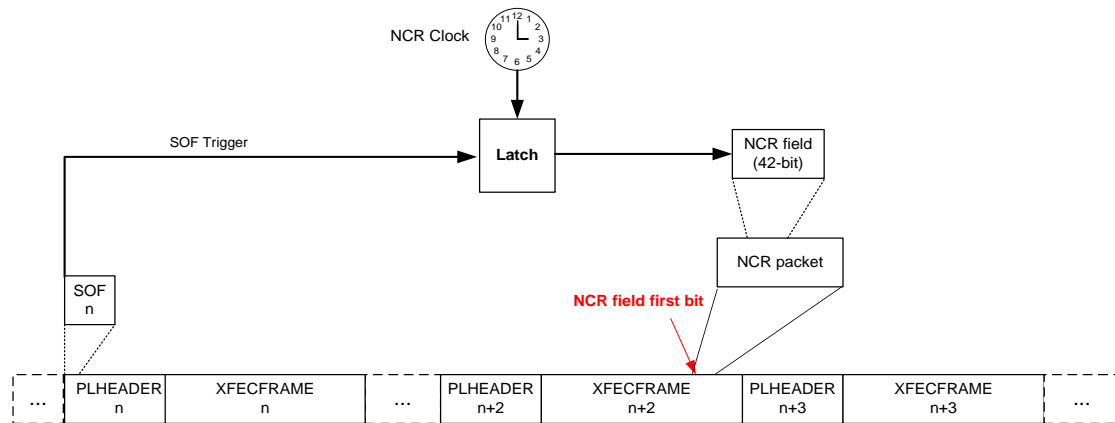

Figure 6-2: Association of NCR Value to SOF

Figure 6-2 illustrates an NCR packet sent in a DVB-S2(X) frame (PLHEADER + XFECFRAME). Each NCR packet shall be kept in one DVB-S2(X) frame. A DVB-S2(X) TDM may contain multiple streams. The timing resolution is unambiguous as the location of the reference SOF relates at the DVB-S2(X) frame multiplex level to the DVB-S2(X) frame with the NCR packet, equally for multi-stream and single stream configurations.

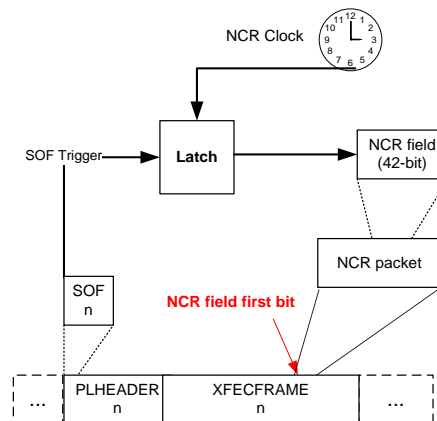

Figure 6-3: Association of NCR Value to SOF for NCRv2

Figure 6-3 illustrates the optional NCRv2 method. The difference is that the offset is 0 instead of 2:

- To construct a local reference NCR the RCST shall associate the received NCR value with the submission time of a forward link timing reference symbol as issued at the return link satellite position. The first symbol of the Start-Of-Frame field of the Nth DVB-S2(X) physical layer frame serves as the reference symbol for an NCR packet where the most significant bit of the NCR packet is carried in the Nth DVB-S2(X) physical layer frame.

6.2.1.2 NCR in TS Packet Stream (optional)

For DVB-S2X without NCRv2, DVB-S, and DVB-S2 refer to ETSI EN 301 790 [1] for NCR broadcast in TS packets.

For DVB-S2X with NCRv2 the following mechanism shall be applied.

The NCR is distributed with a specific PID within the MPEG2 Transport Stream that carries the Forward Link Signalling.

To be able to construct a reference time axis for TDMA transmissions in case of a DVB-S2X with NCRv2, the RCST will associate a successfully received NCR field value with the arrival time at a system dependent reference point of a forward link reference_symbol.

The reference_symbol shall be the first symbol of the Start-Of-Frame field of the N-th DVB-S2X physical layer frame for an NCR field the most significant bit of which is carried in the (N)th DVB-S2X physical layer frame.

No ambiguity arises if an NCR field is split over two physical layer frames since the most significant NCR bit is always transmitted in the first physical layer frame.

6.2.2 Broadcast Tables

6.2.2.0 Introduction

The tables in this clause shall be sent by un-addressed transport.

6.2.2.1 Network Information Table (NIT)

The RCST tunes to an entry stream in a TDM and finds from the NIT the location of the RMT for the two-way service. Other streams may have a NIT for informational purpose.

The NIT provides the RCST with the following administratively scoped identifier:

- a) Original Network ID.

6.2.2.2 RCS Map Table (RMT)

The RMT is used to map the two-way service to specific satellite transport and also to provide the reference to the superframe sequence where a specific RCST shall issue the logon bursts. An RCST selects transport references and configuration data from the RMT associated with the Population ID value that the RCST has been given in advance.

The RMT provides the RCST with the following administratively scoped identifiers:

- a) Interactive Network ID.
- b) NCC ID.
- c) Satellite IDs for forward link and return link.
- d) Beam IDs for forward link and return link.
- e) GW ID.
- f) Local link ID for each forward link.

6.2.2.3 Superframe Composition Table (SCT)

The SCT specifies the sub-division of the resources in a superframe into frames. The table specifies superframe types each associated with one superframe sequence. The table contains for each superframe type identification of the superframe sequence, a centre frequency, an absolute start time expressed as an NCR value and a superframe count. Each superframe is further divided into frames, each frame of a specific frame type. The frames are positioned relative to the centre frequency and start time of the associated superframe.

6.2.2.4 Frame Composition Table version 2 (FCT2)

The Frame Composition Table version 2 defines the timeslot organization of the frame types used to implement the different superframe types. Each frame type is structured into a number of timeslots and this decides the timeslot numbering for a frame of that type. Each frame type is constructed using a single bandwidth-time-unit type and each timeslot in the frame type is built by one or more of these BTUs. The BTU determines the symbol rate of the frame as well as the occupied BW. A timeslot in the frame type may refer to a specific default transmission type (default_tx_type), and the specification of the transmission type is found in the BCT. A timeslot may alternatively not be bound to a transmission type by the FCT2. The binding is then provided by the TBTP2 by a dynamic_tx_type referring to the BCT. The default transmission type may be associated to a timeslot that is not assigned to an allocation channel. The TBTP2 may then, when assigning this timeslot to a specific RCST change to a transmission type with another modulation, another coding and another burst construction as long as using a transmission type with the same timeslot size and the same content type.

6.2.2.5 Broadcast Configuration Table (BCT)

This table defines the transmission parameters for each transmission type. The transmission type to be used is indicated in advance of transmission by explicit reference to the associated transmission type. The BCT provides information about the transmission properties such as relative start of transmission, relative end of transmission, modulation, code rate, preamble, postamble, pilot usage, payload size, payload content and others, depending on the transmission format class of the MF-TDMA frame where the transmission shall take place and the specifics of the transmission type. The BCT may be used to specify transmission formats for continuous transmission from the RCST.

6.2.2.6 Satellite Position Table (SPT) and Satellite Access Tables (SAT)

The SPT contains the satellite ephemeris data. It may be updated at regular intervals to compensate for changes in the satellite ephemeris. The table shall contain ephemeris data for those satellites that constitute a part of a particular network. The SAT contain ephemeris data for non-GSO satellites and additional information about the system deployment, including cell fragment definition, and beam-hopping time plan description.

6.2.2.7 Correction Message Table (CMT)

The NCC sends the CMT to groups of RCSTs. The purpose of the CMT is to advise the logged-on RCSTs what corrections shall be made to their transmitted bursts. The CMT provides correction values for burst frequency, timing and amplitude to individual RCSTs identified by Logon ID and Group ID. The CMT contains the corrections for the RCSTs with the most recently measured Control bursts.

6.2.2.8 Terminal Burst Time Plan Table version 2 (TBTP2)

The TBTP2 may be used to:

- assign dedicated access timeslots to RCSTs;
- assign to RCSTs carriers and formats for continuous transmission;
- assign the transmission type to be used in the specific timeslots or series of timeslots by reference to the BCT;
- allocate timeslots for random access and indicate the random access channel for a timeslot.

Each TBTP2 instance is scoped for the intersection of a logon group ID, a superframe sequence and a superframe within this sequence. It may also be scoped for a specific transmission context. Several TBTP2 instances may be used to assign all the timeslots of a superframe.

6.2.2.9 Multicast Mapping Table version 2 (MMT2)

The MMT2 may be used by the NCC to indicate the mapping from a higher layer multicast address to a MAC24 address, to be used within each SVN.

The multicast mapping method to use is indicated to the RCST in the Logon Response descriptor.

6.2.2.10 Transmission Mode Support Table version 2 (TMST2)

The TMST2 may be used to:

- Indicate the system margin required in the ACM feedback when deciding the least margin MODCOD.
- Indicate per MODCOD the additional margin to be applied when deciding the least margin MODCOD.
- Indicate ISI to MODCOD mapping, allowing receivers to locate the streams with the wanted MODCODs when using a multiple-stream TDM.

6.2.2.11 Fast Access Table (FAT)

The FAT may be used to:

- Indicate the additional transmission timing offset to be added when sending the logon burst.
- Indicate the random access back pressure level to be applied, per random access allocation channel.

6.2.2.12 Supplementary Tables (optional)

A forward link may provide supplementary DVB tables e.g. like the Service Description Table (SDT) and the Time and Date Table (TDT), as specified by ETSI EN 300 468 [3].

Utilization of these supplementary tables is implementation dependent.

6.2.3 Terminal Information Message (TIM)

The TIM is either a unicast (TIM-U) by the NCC to a specific RCST addressed by its MAC48 address or broadcast (TIM-B) from the NCC to all RCSTs connected to the forward link. It contains information in the form of control/status flags and descriptors. The RCST shall silently discard descriptors individually, concerning other descriptors than those specified in the present document and recognized as critical, and shall commence operation with the recognized descriptors unless specified otherwise.

The NCC shall respond with a TIM-U to the RCST when receiving a legitimate logon request from the RCST. The TIM-U is also sent as required to instruct the RCST. When a TIM-U contains multiple descriptors, the terminal shall process all the recognized descriptors before changing its configuration. This is intended to avoid transient inconsistencies.

The TIM-B will need to be transmitted sufficiently often that newly powered terminals can acquire necessary information within a reasonable time window. This matches a similar requirement for the SCT, FCT2 and BCT signals, suggesting the same repeat interval.

6.3 Refresh and Update Intervals

The SCT, FCT2, BCT, SPT, SAT, TMST2 and TIM-B shall be transmitted at least every 10 s to allow newly activated RCSTs to rapidly acquire the necessary start-up state. In addition, the TIM-B shall be updated as required to reflect system status changes requiring immediate notification of the RCSTs.

The TBTP2 shall be updated every superframe.

The CMT will nominally be sent at least once each dedicated control burst transmission interval.

The update rate of the NCR shall be at least 10 times per second. The refresh rate of the Transmission Offset descriptor transmitted in the FAT shall be at least once per second, if this descriptor is used.

The update rate of the FAT is dependent on the use of the optional random access load control and on the change rate of the optional transmission offset.

The TIM-U will be updated as needed to reflect changes affecting a given RCST.

6.4 Syntax and Coding of FL Signals for L2S

6.4.0 Introduction

The present document mandates operation with a single continuous generic stream using GSE packets (ETSI TS 102 606 [8]). The lower-layer signals to be sent over GSE is specified here. These lower layer signals may alternatively be sent over a TS Packet stream. The signals are structured to allow integration of the present signalling system with the signalling system specified for ETSI EN 301 790 [1] on a shared TS.

6.4.1 Table and Message Identification and Placement

Table 6-1 shows the usage of the different table identifiers. This usage is aligned with ETSI EN 301 790 [1].

Table 6-1: Table_id usage

Table and Message	Table_id
Reserved by ETSI EN 301 790 [1]	0x00 to 0x3F
NIT	0x40

Table and Message	Table_id
RMT	0x41
Reserved by ETSI EN 301 790 [1]	0x42 to 0x4C
SAT	0x4D
Reserved by ETSI EN 301 790 [1]	0x4E to 0x69
TDT	0x70
Reserved by ETSI EN 301 790 [1]	0x71 to 0x9F
SCT	0xA0
Reserved	0xA1
Reserved	0xA2
SPT	0xA3
CMT	0xA4
Reserved by ETSI EN 301 790 [1]	0xA5
Reserved by ETSI EN 301 790 [1]	0xA6
Reserved by ETSI EN 301 790 [1]	0xA7 to 0xAA
FCT2 (new)	0xAB
BCT (new)	0xAC
TBTP2 (new)	0xAD
TMST2 (new)	0xAE
FAT (new)	0xAF
TIM-B and TIM-U	0xB0
LL_FEC_parity_data_table	0xB1
MMT2 (new)	0xB2
Reserved for use by ETSI TS 102 606 [8]	0xB3 to 0xB5
Reserved for future use	0xB6 to 0xBF
User defined	0xC0 to 0xFE
Reserved for TS sync	0xFF
NOTE: The tables and messages not specifically tagged as (new) are inherited from ETSI EN 301 790 [1].	

The PID values identifying the different elementary streams in the TS packet stream carrying the different tables and messages in the stream shall be found in the PMT using the principle specified in ETSI EN 301 790 [1].

Table 6-2 lists the descriptors defined within the present document and also values occupied by other DVB specifications including (ETSI EN 301 790 [1]), giving the descriptor-tag values and the intended placement within the tables.

Table 6-2: Descriptor Type Identification and Location

Descriptor type	Identifier (Tag value)	PMT	NIT	RMT	TIM		FAT
					TIM-B	TIM-U	
Reserved	0x00 - 0x49						
Linkage_descriptor	0x4A		X	X			
Reserved	0x4B - 0x9F						
Network_layer_info_descriptor	0xA0					X	
Correction_message_descriptor	0xA1					X	
Reserved for ETSI EN 301 790 [1]	0xA2						
Reserved for ETSI EN 301 790 [1]	0xA3						
Control_assign_descriptor	0xA4					X	
Reserved for ETSI EN 301 790 [1]	0xA5						
Echo_value_descriptor	0xA6				X	X	
RCS_content_descriptor	0xA7	X					

Descriptor type	Identifier (Tag value)	PMT	NIT	RMT	TIM		FAT
					TIM-B	TIM-U	
Satellite_forward_link_descriptor	0xA8			X		X	
Satellite_return_link_descriptor	0xA9			X		X	
Reserved for ETSI EN 301 790 [1]	0xAA						
Logon_Contention_descriptor	0xAB				X		
Correction_control_descriptor	0xAC				X		
Reserved for ETSI EN 301 790 [1]	0xAD						
Reserved for ETSI EN 301 790 [1]	0xAE						
Reserved for ETSI EN 301 790 [1]	0xAF					X	
Mobility_control_descriptor	0xB0					X	
Correction_message_extension_descriptor	0xB1					X	
Return_Transmission_Modes_descriptor	0xB2				X	X	
Reserved for ETSI EN 301 790 [1]	0xB3						
Reserved by ETSI EN 301 790 [1]	0xB4						
Implementation_type_descriptor	0xB5				X		
LL_FEC_identifier_descriptor	0xB6				X	X	
Frame_payload_format_descriptor (new)	0xB7				X		
Pointing_alignment_support_descriptor (new)	0xB8				X		
Logon_response_descriptor (new)	0xB9					X	
DHCP_option_descriptor (new)	0xBA				X	X	
lower_layer_service_descriptor (new)	0xBB					X	
TRANSEC_message_descriptor (new)	0xBC				X	X	
Forward_link_streams_descriptor (new)	0xBD				X	X	
Logon_Security_descriptor (new)	0xBE				X	X	
Transmission_offset_descriptor (new)	0xBF						X
Random_assess_load_control_descriptor (new)	0xC0						X
CLI_instruction_descriptor (new)	0xC1				X	X	
random_access_traffic_method_descriptor (new)	0xC2				X		
Reserved	0xC3						
higher_layers_initialize_descriptor (new)	0xC4					X	
lowest_sw_version_descriptor (new)	0xC5				X		
Mesh_system_descriptor (new)	0xC6						
Extension_protocol_descriptor (new)	0xC7						
Continuous_carrier_control_descriptor (new)	0xC8					X	
Satellite_forward_link_v2_descriptor (new)	0xC9			X		X	
Satellite_return_link_v2_descriptor (new)	0xCA			X		X	
Transmission offset V2 descriptor (new)	0xCB						X
Reserved by the present document	0xCC to 0xDF						
User defined	0xE0 to 0xFE						

The RCST shall silently discard each descriptor that it does not support and shall receive those it does support. The descriptors are generically designed as type-length-value constructs to support discarding only those that are not recognized.

6.4.2 The NCR Packet

Table 6-3 specifies the format and syntax of the content of the GSE PDU with an NCR packet. The NCR shall be sent in an unfragmented and unlabelled (LT="10" binary or 2 decimal) GSE packet identified by a protocol type value dedicated to NCR.

Table 6-3: Syntax of the NCR Packet Content

Syntax	No. of bits		Mnemonic
	Reserved	Information	
ncr_packet_content {			
ncr_base		33	uimsbf
ncr_extension	6	9	uimsbf
}			

The semantics of the ncr_packet_content is as follows:

- `ncr_base`: 33 bits holding the NCR div 300 as specified in ETSI EN 301 790 [1] and ISO/IEC 13818-1 [6].
- `ncr_extension`: 9 bits holding the NCR modulo 300 as specified in ETSI EN 301 790 [1] and ISO/IEC 13818-1 [6].

NOTE: The format with the separation of base and extension by 6 reserved bits equals the MPEG TS PCR format as specified in ISO/IEC 13818-1 [6] and used in ETSI EN 301 790 [1].

6.4.3 Transport of Configuration Tables and Messages

6.4.3.1 Transport in Continuous Generic Stream

6.4.3.1.0 Introduction

The configuration tables and messages shall in a DVB-S2(X) continuous generic stream be transported in GSE packets as specified in ETSI TS 102 606 [8] and frame payload that may be implemented with the amendments specified in the present document.

6.4.3.1.1 Un-addressed Lower Layer Signalling Transport in GSE Packets

The SE=11 and SE=10 GSE packets used to transport an un-addressed table shall omit the packet label (LT="10" or 2 decimal) and shall use the protocol type associated to LL signalling. The table content shall be inserted in the structure specified in table 6-4 before mapping to GSE PDUs, fragmenting as necessary. The version number is incremented by 1 when a change in the information carried with the table occurs.

Table 6-4: Syntax of Table Structure used in GSE Packets

Syntax	No. of bits		Mnemonic
	Reserved	Information	
<code>gse_table_structure () {</code>			
<code>table_id</code>		8	uimsbf
<code>interactive_network_id</code>		16	uimsbf
<code>reserved</code>		2	bslbf
<code>version_number</code>		5	uimsbf
<code>current_next_indicator</code>		1	bslbf
<code>for (i=0; i < N; i++) {</code>			
<code>table_content_byte</code>		8	bslbf
<code>}</code>			
<code>}</code>			

Semantics for the `gse_table_structure`:

- `table_id`: This 8 bit field identifies the specific table;
- `interactive_network_id`: This is a 16-bit field which serves as a label to identify the Satellite Interactive Network, to which the table applies;
- `version_number`: This 5-bit field is the version number of the table. When it reaches value 31, it wraps around to 0;
- `current_next_indicator`: This 1-bit indicator, when set to "1" indicates that this table version is the currently applicable. When the bit is set to "0", it indicates that this table version is not yet applicable and shall be the next table to be valid;
- `table_content_byte`: This 8 bit field holds one byte of the chronological sequence of bytes of the respective GSE packet for the table content for the specific table. A following GSE packet starts with the table content byte following the last table content byte in the preceding GSE packet, and so forth.

6.4.3.1.2 Addressed Lower Layer Signalling Transport in GSE Packets

The table content shall be inserted in the structure specified in table 6-4 before mapping to GSE PDUs, fragmenting as necessary. Both the SE=11 GSE packets and the SE=10 GSE packets transporting the addressed table shall use 6 byte packet label (LT="00" or 0 decimal) with content applicable for lower layer signalling and shall indicate the protocol type value associated to the internal lower layer signalling.

6.4.3.2 Transport in TS Packets (optional)

6.4.3.2.0 Introduction

A TS packet stream carrying the signalling elements shall be identified by a TS ID as specified in ISO/IEC 13818-1 [6] and shall contain PAT and PMT for identifying and locating the elements of the stream.

6.4.3.2.1 Un-addressed Transport in TS Packets (optional)

The table section construction aligns with the section construction used in ETSI EN 300 468 [3].

Table 6-5: Syntax of Un-addressed Table Section in TS Packets

Syntax	No. of bits		Mnemonic
	Reserved	Information	
unaddressed_table_section() {			
table_id		8	uimsbf
section_syntax_indicator		1	bslbf
reserved_for_future_use		1	bslbf
reserved		2	bslbf
section_length		12	uimsbf
interactive_network_id		16	uimsbf
reserved		2	bslbf
version_number		5	uimsbf
current_next_indicator		1	bslbf
section_number		8	uimsbf
last_section_number		8	uimsbf
for (i=0; i < section_length - 9; i++) {			
table_section_content_byte		8	bslbf
}			
CRC_32		32	rpchof
}			

Semantics for the unaddressed_table_section:

- table_id: This 8 bit field identifies the specific table;
- section_syntax_indicator: This is a 1-bit field which shall be set to "1";
- section_length: This is a 12-bit field, the first two bits of which shall be "00". It specifies the number of bytes of the section, starting immediately following the section_length field and including the CRC_32. The section_length shall not exceed 1 021 so that the entire table_section has a maximum length of 1 024 bytes;
- interactive_network_id: This is a 16-bit field which serves as a label to identify the Satellite Interactive Network, to which the table applies;
- version_number: This 5-bit field is the version number of the table. The version_number shall be incremented by 1 when a change in the information carried with the table occurs. When it reaches value 31, it wraps around to 0;
- current_next_indicator: This 1-bit indicator, when set to "1" indicates that this table version is the currently applicable. When the bit is set to "0", it indicates that this table version is not yet applicable and shall be the next table to be valid;

- **section_number:** This 8-bit field gives the number of this section. The **section_number** of the first section of the table shall be "0x00". The **section_number** shall be incremented by 1 for each section carrying a consecutive adjacent section of the table content;
- **last_section_number:** This 8-bit field specifies the number of the last section (that is, the section with the highest **section_number**) of the table content that this section is a part of;
- **table_section_content_byte:** This 8 bit field holds one byte of the chronological sequence of bytes of the respective section of the table content for the specific table. The second section starts with the table content byte following the last table content byte in the first section, and so forth. Table content may e.g. be sectioned as follows.

Table 6-6: Capacity of Table Sections in TS Packets

Table section	Table section content when maximizing the size of each section
0x00	Table content byte 1 - 1 020
0x01	Table content byte 1 021 - 2 041
0x02	Table content byte 2 042 - n (n < 3 062)

- **CRC_32:** This is a 32-bit field that contains the CRC value that gives a zero output of the registers in the decoder defined in annex B of ETSI EN 300 468 [3] after processing the entire clause.

6.4.3.2.2 Addressed Lower Layer Signal Transport in TS Packet Stream (optional)

Table 6-7 specifies the syntax of the lower layer signalling transported in a TS Packet stream.

Table 6-7: Syntax of Addressed Table Section in TS Packet Stream

Syntax	No. of bits	Mnemonic
addressed_table_section () {		
table_id	'0xB0'	uimsbf
section_syntax_indicator	1	bslbf
private_indicator	1	bslbf
reserved	2	bslbf
section_length	12	uimsbf
MAC_address_6	8	uimsbf
MAC_address_5	8	uimsbf
reserved	2	bslbf
payload_scrambling_control	2	bslbf
address_scrambling_control	2	bslbf
LLC_SNAP_flag	1	bslbf
current_next_indicator	1	bslbf
section_number	8	uimsbf
last_section_number	8	uimsbf
for (i=0; i < section_length - 9; i++) {		
table_section_content_byte	8	bslbf
}		
CRC_32	32	rpchof
}		

The addressed section construction aligns with the section constructions for [DSM-CC] and [DVB-SI].

Semantics for the **addressed_table_section**:

- **table_id:** This 8 bit field identifies the table;
- **section_syntax_indicator:** The **section_syntax_indicator** is a 1-bit field which shall be set to "1" to denote that a CRC32 check field is used at the end of the section;
- **private_indicator:** The **private_indicator** is a 1 bit field that shall be set to the complement of the **section_syntax_indicator** (i.e. to "0");

- **section_length:** This is a 12-bit field, the first two bits of which shall be "00". It specifies the number of bytes of the section, starting immediately following the section_length field and including the CRC. The section_length shall not exceed 1 023 so that the entire section has a maximum length of 1 026 bytes;
- **MAC_address_[5 and 6]:** This 16 bit field contains the 2 least significant byte of the MAC address of the destination. The MAC_address_6 contains the least significant byte;

NOTE: The order of the bits in the byte is not reversed, and the MSB of each byte is still transmitted first.

- **payload_scrambling_control:** this 2 bit field defines the scrambling mode of the payload section. This includes the payload starting after the MAC_address_1 but excludes the CRC32 field. The scrambling method applied is user private;

Table 6-8: Coding of the Payload Scrambling Control Field

Value	Payload scrambling control
00	unscrambled
01	defined by service
10	defined by service
11	defined by service

- **address_scrambling_control:** this 2 bit field identifies the scrambling mode of the MAC address section. The scrambling method applied is user private;

Table 6-9: Coding of the Address Scrambling Control Field

Value	Address scrambling control
00	unscrambled
01	defined by service
10	defined by service
11	defined by service

- **LLC_SNAP_flag:** This 1 bit flag shall be set to "0" to indicate that the payload does not use LLC/SNAP encapsulation;
- **current_next_indicator:** This 1-bit field shall be set to "1";
- **section_number:** This 8-bit field gives the number of the section. The section_number of the first section in the message shall be "0x00". The section_number shall be incremented by 1 with each additional section for the same message;
- **last_section_number:** This 8-bit field specifies the number of the last section (that is, the section with the highest section_number) of the message of which this section is part;
- **table_section_content_byte:** This 8 bit field holds one byte of the chronological sequence of bytes of the respective section of the addressed table content for the specific table. The second section starts with the table content byte following the last addressed table content byte in the first section, and so forth;

the addressed table content may e.g. be sectioned as shown in table 6-10;

Table 6-10: Maximum Table Section Sizes

Table section	Table section content when maximizing the size of each section
0x00	Addressed table content byte 1 - 1 020
0x01	Addressed table content byte 1 021 - 2 041
0x02	Addressed table content byte 2 042 - n (n < 3 062)

when using multiple sections, the 4 most significant bytes of the MAC address do only appear in the first section. The table content in the first section is thus never less than 4 bytes. The 2 least significant bytes of the MAC address appear in the header of every section. The content to be sectioned is constructed by concatenating the table content with the 4 most significant bytes of the address as shown in table 6-11;

Table 6-11: Concatenation of 4 MSB MAC Address Bytes with Table Content

Data block	Information	Mnemonic
addressed_content () {		
MAC_address_4	8	uimsbf
MAC_address_3	8	uimsbf
MAC_address_2	8	uimsbf
MAC_address_1	8	uimsbf
for (i=0; i < n; i++) {		
table_content_byte	8	bslbf
}		
}		

- MAC_address_[1 to 4]: This 32 bit field contains the 4 most significant byte of the MAC address of the destination. The MAC_address_1 field contains the most significant byte of the MAC address;
- table_content_byte: This 8 bit field holds one byte of the contiguous sequence of n bytes of the content for the specific table;
- CRC_32: This is a 32-bit field that contains the CRC value that gives a zero output of the registers in the decoder defined in annex B of ETSI EN 300 468 [3] after processing the entire section.

6.4.4 The SCT Content

The SCT specified in table 6-12 provides the organization of the RCST transmission resources of the satellite interactive network, in particular the sub-division of the superframe structure into frames. The combination of the interactive_network_id and the superframe_sequence allows each superframe sequence to be uniquely identified within the interactive network. Solely a coordinated change of the reference superframe_count and the superframe_start_time value that does not offset the alignment between the superframe sequence and the broadcast NCR is not considered a new version of the SCT since the structure and alignment is unchanged, even if the contents of these fields change.

Table 6-12: Syntax of the Superframe Composition Table Content

Syntax	No. of bits		Mnemonic
	Reserved	Information	
superframe_composition_content(){			
superframe_loop_count		8	uimsbf
for(i=0;i<=superframe_loop_count;i++){			
superframe_sequence		8	uimsbf
large_timing_uncertainty_flag		1	bslbf
uplink_polarization	5	2	bslbf
superframe_start_time_base		33	uimsbf
superframe_start_time_ext	6	9	uimsbf
superframe_duration		32	ncvmsbf
superframe_centre_frequency		32	uimsbf
superframe_count		16	uimsbf
frame_loop_count	3	5	uimsbf
for(j=0;j<=frame_loop_count;j++){			
frame_type		8	uimsbf
frame_start_time		32	ncvmsbf
frame_centre_frequency_offset		24	tcimsbf
}			
}			
}			

Semantics for the `superframe_composition_content`:

- `superframe_loop_count`: This is an 8-bit field which identifies one less than the number of superframe types that are specified, i.e. the number of iterations of the following loop;
- `superframe_sequence`: This is an 8-bit field which serves as a label for identification of the superframe sequence within the satellite interactive network;
- `large_timing_uncertainty_flag`: This flag when set to "0" indicates that the large timing uncertainty logon procedure is supported in the superframe sequence and that the Correction Message Extension Descriptor will be sent together with the Correction Message Descriptor as required;
- `uplink_polarization`: This is a 2-bit field specifying the polarization of the transmitted signal (see table 6-13);

Table 6-13: Polarization definition

Polarization	Value
linear - horizontal	00
linear - vertical	01
circular - left	10
circular - right	11

- `superframe_start_time_base` and `superframe_start_time_ext`: These two fields give the absolute time of the beginning of the superframe numbered `superframe_count` in the superframe sequence, with reference to NCR, referring to the NCR value occurrence closest in time relative to the current value of the received NCR. The coding of the fields is identical to the coding of the NCR, with the two fields corresponding to the base and extension parts of the NCR respectively;
- `superframe_duration`: This 32-bit field gives the duration of each superframe of the superframe sequence, in terms of NCR counts. The 32 bits correspond to a maximum duration of 93,2 s;
- `superframe_centre_frequency`: This 32-bit field gives the absolute centre frequency of the superframe sequence. The frequency is given in multiples of 100 Hz;
- `superframe_count`: This 16 bit field gives the `superframe_count` value for the reference superframe for the start time;
- `frame_loop_count`: This 5 bit field indicates one less than the number of iterations in the loop that follows. A zero count indicates one loop. The frame numbers follow the numbering convention defined in clause 7.5.1;
- `frame_type` gives the frame type identifier for the j^{th} frame, corresponding to a frame type defined in the FCT2;
- `frame_start_time`: This 32 bit field gives the start time of the j^{th} frame relative to the superframe start time, in terms of NCR count intervals. The 32 bits correspond to a maximum duration of 93,2 s;
- `frame_centre_frequency_offset`: This 24-bit field gives the signed offset of the centre frequency of the j^{th} frame relative to the `superframe_centre_frequency` parameter (SCT). The frequency is given in multiples of 100 Hz.

6.4.5 The FCT2 Content

The FCT2 specified in table 6-14 provides the specification of the different frame types.

Table 6-14: Syntax of the Frame Composition Table 2 Content

Syntax	No. of bits		Mnemonic
	Reserved	Information	
frame_composition_table_2_content {			
frame_type_loop_count		8	uimsbf
for (i=0;i<=frame_type_loop_count;i++) {			
frame_type		8	uimsbf
frame_duration		32	uimsbf
tx_format_class		8	uimsbf
btu_duration		24	uimsbf
btu_carrier_bw		24	uimsbf
btu_symbol_rate		24	uimsbf
time_unit_count		16	uimsbf
grid_repeat_count		8	uimsbf
for (j=0;j<grid_repeat_count;j++) {			
grid_frequency_offset		24	tcimsbf
}			
section_loop_count		8	uimsbf
for (k=0; k<= section_loop_count; k++) {			
default_tx_type		8	uimsbf
fixed_access_method	4	4	uimsbf
repeat_count		16	uimsbf
}			
}			

Semantics for the frame_composition_table_2_content:

- frame_type_loop_count: This is an 8-bit field indicating one less than the number of iterations of the frame type loop that follows. A zero count indicates one loop;
- frame_type: This 8-bit field serves as a label for identification of the frame type;
- frame_duration: This 32-bit field gives the time duration of the 'ith' frame type identified by the frame_id, in terms of NCR ticks. For continuous carrier operation this parameter is only used as timing reference for carrier assignment control, it does not represent a property of the carrier;
- tx_format_class: This field indicates the transmission format class of all transmission types used in the frame type. The values are assigned in table 6-15;

Table 6-15: Coding of Transmission Format Classes

Value	tx_format_class
0	Reserved
1	Linear Modulation Burst Transmission
2	Continuous Phase Modulation Burst Transmission
3	Continuous Transmission
4	Spread-Spectrum Linear Modulation Burst Transmission
5 to 127	Reserved
128 to 255	User defined

- btu_duration: This field indicates the duration of one BTU in NCR ticks;
- btu_carrier_bw: This field indicates the bandwidth occupied by one BTU in multiples of 10 Hz;
- btu_symbol_rate: This field indicates the symbol rate used in one BTU in multiples of 10 symbols/s;
- time_unit_count: This field indicates the number of BTUs along the time axis for this frame;
- grid_repeat_count: This as an 8-bit field indicating the exact number of iterations of the loop that follows, defining additional unit bandwidth BTU grids. A zero count value indicates no iterations as one unit bandwidth grid is placed at the frame centre frequency with zero frequency offset;

- `grid_frequency_offset`: This field indicates the offset along the frequency axis for the respective unit bandwidth BTU grid with reference to the frame centre frequency as given in the SCT, in units of 100 Hz. Appropriate offset(s) are given when using two or more grids in the frame type;
- `section_loop_count`: This is an 8-bit field indicating one less than the number of iterations of the frame section loop that follows. A zero count indicates one loop. The ordering of the iterations follows a scheme where the frame sections are addressed incrementally according to ascending time and coarsely according to ascending frequency. The first iteration addresses the section that starts at the time offset specified for the frame and resides at the lowest frequency defined for the frame as given by the `grid_frequency_offsets`;
- `default_tx_type`: This 8 bit field may identify the specific `tx_type` to be used for the k^{th} section of the frame as a non-zero value correspond to a `tx_type` definitions in the BCT. The number of BTUs for the timeslot is then given by the specification of the `tx_type`. The value 0 refers to a single BTU that is intended to be allocated to a timeslot and a specific `tx_type` by the TBTP2. The indicated `tx_type` may be changed by the TBTP2 if `fixed_access_method=0`;
- `fixed_access_method`: This 4 bit field indicates the access method to be used for the timeslots in frame section when `default_tx_type > 0`. Then it allocates the timeslots to `RA-AC-index = (15 - fixed_access_method)`. The value 0 indicates that the access method is determined by other means. The field is reserved when `default_tx_type = 0`;
- `repeat_count`: This 16 bit field value is the number of repeats of the associated `tx_type`. The value is one less than the total number of successive frame sections for the given type. E.g. a value of 0 indicates no repeats (1 occurrence only), while a value of 2 indicates 2 further repeats for a total of 3.

6.4.6 The BCT Content

6.4.6.0 Introduction

The BCT as shown in table 6-16 specifies the different transmission types.

Table 6-16: Syntax of the Broadcast Configuration Table Content

Syntax	No. of bits		Mnemonic
	Reserved	Information	
<code>broadcast_configuration_table_content() {</code>			
<code>tx_type_loop_count</code>		8	uimsbf
<code>for (i=0; i < tx_type_loop_count; i++) {</code>			
<code>tx_type</code>		8	uimsbf
<code>tx_content_type</code>		8	uimsbf
<code>tx_format_class</code>		8	uimsbf
<code>tx_format_data_length</code>		8	uimsbf
<code>for (n=0; n < tx_format_data_length; n++) {</code>			
<code>tx_format_data_byte</code>		8	bsb1f
<code>}</code>			
<code>}</code>			
<code>}</code>			

Semantics for the `broadcast_configuration_table_content`:

- `tx_type_loop_count`: This is an 8-bit field indicating the number of iterations of the `tx_type` loop that follows. A count of one indicates one loop;
- `tx_type`: This 8-bit variable identifies a specific broadcast transmission format specification. The value zero is reserved and cannot be used to refer to a broadcast configuration;
- `tx_content_type`: This 8 bit field identifies the payload content type to be carried by the `tx_type` and is encoded as specified in table 6-17;

Table 6-17: Coding of Transmission Content Type

Value	<code>tx_content_type</code>
-------	------------------------------

0	Reserved
1	Logon Payload
2	Control Payload
3	Traffic and Control Payload
4	Traffic Payload
5 to 127	Reserved
128 to 255	User defined content

- `tx_format_class`: The class of the TX format indicating the structure variant of the `tx_format_descriptor` data. The values are as specified for table FCT2;
- `tx_format_data_length`: The size of the format data block in bytes;
- `tx_format_data_byte`: This one byte field holds one byte in the contiguous sequence of bytes constituting the format specification data block specifying the format. The syntax depends on the `tx_format_class`.

NOTE: Three alternative methods may be used to control the selection of `tx_type` for a timeslot. The `default_tx_type` can be statically given through SCT/FCT2/BCT and determine the `tx_type`, or the TBTP2 may override the default `tx_type`, or the SCT/FCT2 may define a generic BTU grid that is exploited via TBTP2 by controlling transmission content type, modulation, coding and size by reference to the `tx_type` from the TBTP2.

6.4.6.1 Format Data Block for LM Burst

The syntax of the data block providing the configuration for linear modulation is specified in table 6-18.

Table 6-18: Syntax of the Data Block for the TC-LM Transmission Format Class

Syntax	No. of bits		Mnemonic
	Reserved	Information	
lm_data_block {			
tx_block_size		8	uimsbf
threshold_es_n0		8	uimsbf
tx_start_offset_part1		8	uimsbf
tx_start_offset_part2	4	20	uimsbf
if (tx_type > 127) {			
payload_size		16	uimsbf
modulation_scheme		8	uimsbf
P		8	uimsbf
Q0	4	4	uimsbf
Q1	4	4	uimsbf
Q2	4	4	uimsbf
Q3	4	4	uimsbf
Y_period	3	5	uimsbf
W_period	3	5	uimsbf
for (j=0; j<Y_period; j++) {			
Y_pattern_bit		1	bslbf
while (!byte_aligned) {			
stuffing_bit		1	bslbf
}			
}			
for (j=0; j<W_period; j++) {			
W_pattern_bit		1	bslbf
while (!byte_aligned) {			
stuffing_bit		1	bslbf
}			
}			
preamble_len		8	uimsbf
postamble_len		8	uimsbf
pilot_period	4	12	uimsbf
pilot_block_len		8	uimsbf
pilot_sum		8	uimsbf
for (j=0; j<UW_length; j++) {			
UW symbol		<i>m</i>	uimsbf
while (!byte_aligned) {			
stuffing_bit		1	bslbf
}			
}			
else {			
waveform_id		8	uimsbf
}			
}			

Semantics for the lm_data_block:

- tx_block_size: The number of consecutive BTUs required for transmission of the physical layer block used by the specific TX type. This indicates the size of the timeslot required for the burst;
- threshold_es_n0: This is the nominal sensitivity for the transmission type encoded as $(5 * \text{threshold}) + 120$ with the threshold given in dB, and serves as a reference for ACI control as specified in clause 7.3.8;
- tx_start_offset_part1: An 8 bit field that gives one of the two parts of nominal offset for burst start from the start of the timeslot, given in units of 1/4 of the symbol/chip period at the respective carrier. When used, the value of this field is converted to NCR ticks by multiplying by $N/4$, where N is the number of NCR ticks in a symbol period. The result is rounded up to the nearest integer. A value of 255 is interpreted as zero;
- tx_start_offset_part2: A 20 bit field that gives the nominal offset for burst start from the start of the timeslot in units of NCR ticks;

- **tx_type:** This 8 bit field refers to the identifier of the transmission type. Values in the range 1 to 127 are reserved to refer to the reference bursts specified annex A. Values in the range 128 to 255 are used by the NCC to specify waveforms;
- **payload_size:** This 16 bit field indicates the burst payload size in bytes. The value is the channel coding input block size;
- **modulation:** This is an 8-bit field which serves as an identifier of the modulation scheme as defined in table 6-19;

Table 6-19: Modulation Scheme Code Values

Modulation Scheme	Value
Reserved (BPSK)	0x00
QPSK	0x01
8PSK	0x02
16QAM	0x03
Reserved	0x04
$\pi/2$ -BPSK	0x05
Reserved for future use	0x06 to 0x0f
Reserved [spreading]	0x10 to 0x1f
Reserved for future use	0x20 to 0x7f
User defined	0x80 to 0xff

- **P:** This 8 bit field defines the permutation parameter P to be used for the specific burst type;
- **Q0, Q1, Q2 and Q3:** These 4-bit fields define the set of permutation parameters Q0-Q3 to be used for the specific burst type;
- **Y_period, W_Period:** These 5-bit fields specify the puncturing period for each of the parity bits Y and W, respectively;
- **Y pattern, W_pattern:** These 1-bit fields specify 1 bit in the contiguous sequence of bits specifying the puncturing pattern for each of the parity bits Y and W, respectively. A 1 indicates that the corresponding parity bit is to be kept, a 0 indicates that the bit is to be deleted (punctured);
- **stuffing_bit:** 0-7 stuffing bits that are used to align the preceding section with a byte boundary. The bits may take any value. These bits shall be discarded by the RCST;
- **preamble_length:** This 8 bit field specifies the preamble length in symbols;
- **postamble_length:** This 8 bit field specifies the postamble length in symbols;
- **pilot_period:** This 12 bit field specifies the insertion period of pilot blocks in symbols. The last pilot symbol of the first pilot block is positioned as the symbol occurring a pilot period after the last preamble symbol. The pilot period is also the distance between the first symbol of two consecutive pilot blocks. A value of 0 indicates that no pilot symbols are inserted;
- **pilot_block_length:** This 8 bit field indicates the number of symbols in each block of pilot symbols. If pilot_period=0, this field is reserved;
- **pilot_sum:** This 8 bit field specifies the total number of pilot symbols to be inserted. If pilot_period=0 this field is reserved. If pilot_sum equals pilot_block then the construction represents a single midamble sequence. If pilot_sum is a multiple of pilot_block, then the construction represents multiple midamble sequences;
- **UW_length:** This is the length of the UW in symbols. The UW length is implicitly given by the sum of preamble_length, pilot_block_len and postamble_length;

- **UW_symbol:** This m bit field specifies one symbol in the concatenated sequence of preamble symbols, pilot block symbols for one pilot block and postamble symbols. The number of bits m required to specify a symbol is determined by the modulation type ($m=2$ for QPSK, $m=3$ for 8PSK, and $m=4$ for 16QAM). The m bit specifies a symbol to be transmitted, as defined in clauses 7.3.7.1.2 and 7.3.7.1.3. E.g. if the modulation type is QPSK and the combined length of preamble, pilot block and postamble is 82 symbols, the loop will specify 164 bits;
- **waveform_id:** This 8 bit field refers to a reference waveform where some are specified in the present document in annex A.

6.4.6.2 Format Data Block for CPM Burst

The syntax of the data block providing the configuration of Convolutional Coded Continuous Phase Modulation is specified in table 6-20. Algebraic computation of interleaver permutations refers to the algorithm specified in clause 7.3.5.2.1.

Table 6-20: Syntax of the Data Block for the CC-CPM Transmission Format Class

Syntax	No. of bits		Mnemonic
	Reserved	Information	
cpm_data_block {			
tx_block_size		8	uimsbf
threshold_es_n0		8	uimsbf
tx_start_offset	12	20	uimsbf
if (tx_type > 127) {			
modulation_mh		3	uimsbf
modulation_ph		3	uimsbf
modulation_type	1	1	uimsbf
α_{RC}		8	uimsbf
code_rate	3	3	uimsbf
constraint_length_K	1	1	uimsbf
uw_length		8	uimsbf
for (i=0;i<uw_length;i++) {			
uw_symbol		2	uimsbf
}			
while (!bytealigned) {			
stuffing_bit		1	uimsbf
}			
nbr_uw_segments		8	
for (i=0;i<nbr_uw_segments;i++) {			
uw_segment_start		16	uimsbf
uw_segment_length		8	uimsbf
}			
parameterized_interleaver	7	1	uimsbf
if (parameterized_interleaver ==1) {			
N		12	uimsbf
s		6	uimsbf
p		10	uimsbf
$N_1/12$		9	uimsbf
$K_1/12$		9	uimsbf
$K_2/12$		9	uimsbf
$K_3/12$		9	uimsbf
}			
Else {			
for (i=0;i<N-1;i++) {			
$\pi(i)$		12	uimsbf
}		1	uimsbf
}			
While (!bytealigned) {			
stuffing_bit		1	uimsbf
}			
}			

Syntax	No. of bits		Mnemonic
	Reserved	Information	
else {			
waveform_id		8	uimsbf
}			
}			

Semantics for the cpm_data_block:

- tx_block_size: The number of consecutive BTUs required for transmission of the physical layer block used by the specific tx_type. This indicates the size of the timeslot required for the burst.
- threshold_es_n0: This is the nominal sensitivity for the transmission type encoded as $(5 * \text{threshold}) + 120$ with the threshold given in dB, and serves as a reference for ACI control as specified in clause 7.3.8.
- tx_start_offset: A 20 bit field that gives the nominal offset for burst start from the start of the timeslot in units of NCR ticks.
- tx_type: This refers to the identifier of the transmission type. Values in the range 1-127 are reserved to refer to the reference bursts specified in annex A. Values in the range 128-255 are used by the NCC to specify waveforms.
- modulation_m_h: This 3 bit field specifies the numerator in a fraction representing the modulation index. The numerator m_h equals the value of this field +1.
- modulation_p_h: This 3 bit field specifies the denominator in a fraction representing the modulation index. The denominator p_h equals the value of this field +1.
- modulation_type: This 1 bit field specifies the modulation type and the symbol mapping option, as defined in table 6-21.

Table 6-21: Modulation type value

modulation_type value	Modulation	Symbol mapping
1	Quaternary	Gray mapping
0	Quaternary	Linear mapping

- α_{RC} : This is an 8 bit field indicating the value for the pulse shape factor α_{RC} specified in clause 7.3.7.2.1 in units of 1/256.
- code rate: This 3-bit field specifies the code rate as defined in table 6-22.

Table 6-22: Code rate value

Code rate value	Code rate
000	1/2
001	2/3
010	4/5
011	6/7
All other values	reserved

- constraint_length_K: This is a 1-bit field coded as specified in table 6-23.

Table 6-23: Constraint length value

Constraint length code value	Constraint length
0	3
1	4

- **uw_length:** This is an 8 bit field specifying the UW length in symbols. The loop which follows is aligned however on byte boundaries. This means that for example if the UW length is 14 symbols, the loop over the UW_symbol will produce 28 bits.
- **uw_symbol:** This 2 bit field specifies one symbol in the UW. As the UW is not scrambled, a proper sequence shall be selected in order to comply with requirements concerning off-axis EIRP. The symbols are listed in transmission order (first symbol listed = first symbol to send on air interface).
- **stuffing_bit:** This is a 1 bit field of a 0-7 bit stuffing field. Since after the UW specification sequence, the interleaver specification field is byte aligned, stuffing bits are present until the next byte boundary. The stuffing bits may take any value and shall be discarded by the terminal.
- **nbr_UW_segments:** This 8 bit field specifies one less than the number of UW segments to be inserted in the burst. The specified UW is sequentially segmented into this number of segments.
- **uw_segment_start:** This 16 bit field provides the position (expressed in number of bits) of the first bit of the respective UW segment within the burst. A value of zero means the first bit of the burst.
- **uw_segment_length:** This 8 bit field specifies the number of symbols in the respective UW segment.
- **parameterized_interleaver:** This is a 1 bit field. When set to 1, it stipulates that the CPM bit-interleaver permutations be computed algebraically using the parameters N , s , p , $N_1/12$, $K_1/12$, $K_2/12$, $K_3/12$ and the sub-permutation blocks as specified in clause 7.3.5.2.3. When set to 0, the interleaver π is specified by its precomputed permutations $\pi(i)$, $i = 0, 1, \dots, N - 1$.
- **N:** This specifies interleaver length in bits.
- **s:** This 6 bit field represents a constant used in generating the interleaver permutations algebraically.
- **p:** This 10 bit field is an integer co-prime with N and is used in generating the interleaver permutations algebraically.
- **$N_1/12$:** This 9 bit field is an integer used in generating the interleaver permutations algebraically.
- **$K_1/12$:** This 9 bit field is an integer used in generating the interleaver permutations algebraically.
- **$K_2/12$:** This 9 bit field is an integer used in generating the interleaver permutations algebraically.
- **$K_3/12$:** This 9 bit field is an integer used in generating the interleaver permutations algebraically.
- **$\pi(i)$:** This is a 12 bit field holding one interleaver permutation value from the contiguous sequence of N interleaver permutation values for the i th code bit at the convolutional encoder output, such that the sequence number goes from $i = 0, 1, \dots, N-1$.
- **stuffing_bit:** One bit in the sequence of 0 or 4 stuffing bits. Since the interleaver $\pi(i)$ field is not bound to byte alignment, stuffing bits are present until the next byte boundary. The stuffing bits may take any value and shall be discarded by the terminal.
- **waveform_id:** This 8 bit field identifies the waveform to be used for the tx_type.

6.4.6.3 Format Data Block for Continuous Transmission

The syntax of the data block providing the configuration for continuous transmission is specified in table 6-24.

Table 6-24: Syntax of the Data Block for the CC-LM Transmission Format Class

Syntax	No. of bits		Mnemonic
	Reserved	Information	
cclm_data_block {			
threshold_ec_n0		8	uimsbf
if (tx_type > 127) {			
payload_size		16	uimsbf
scrambling		1	bslbf
UW_format		1	bslbf
num_blocks		6	uimsbf
modulation_scheme		8	uimsbf
P		8	uimsbf
Q0	4	4	uimsbf
Q1	4	4	uimsbf
Q2	4	4	uimsbf
Q3	4	4	uimsbf
Y_period	3	5	uimsbf
W_period	3	5	uimsbf
for (j=0; j<Y_period; j++) {			
Y_pattern_bit		1	bslbf
while (!byte_aligned) {			
stuffing_bit		1	bslbf
}			
for (j=0; j<W_period; j++) {			
W_pattern_bit		1	bslbf
while (!byte_aligned) {			
stuffing_bit		1	bslbf
}			
}			
if (scrambling == 1) {			
scrambling_poly		16	uimsbf
scrambling_init		16	uimsbf
}			
preamble_len		8	uimsbf
padding_len		8	uimsbf
pilot_period	4	12	uimsbf
pilot_block_len		8	uimsbf
pilot_sum		16	uimsbf
if (UW_format == 1) {			
for (j=0; j<UW_length; j++) {			
UW_chip		1	uimsbf
}			
while (!byte_aligned) {			
stuffing_bit		1	bslbf
}			
}			
else {			
for (j=0; j<UW_length; j++) {			
UW symbol		<i>m</i>	uimsbf
while (!byte_aligned) {			
stuffing_bit		1	bslbf
}			
}			
}			
else {			
waveform_id		8	uimsbf
}			
}			

Semantics for `cclm_data_block`:

- `threshold_ec_n0`, `tx_type`, `payload_size`: As per clause 6.4.6.4;
- `scrambling`: A value of '1' indicates that long-sequence scrambling shall be performed. A value of 0 indicates that this shall not be performed;
- `UW_format`: A value of '1' indicates that the UW is defined in terms of chips; a value of 0 indicates that it is defined in terms of symbols;
- `num_blocks`: This 6-bit field indicates one less than the number of FEC blocks used in the carrier frame;
- `modulation_scheme`: This is an 8-bit field which serves as an identifier of the modulation scheme as defined in table 6-25. When spread-spectrum transmission is employed, the three LSB of the field indicate the spreading factor as defined in table 6-28;

Table 6-25: Modulation Scheme Code Values

Modulation Scheme	Value
Reserved	0x00
QPSK	0x01
8PSK	0x02
16QAM	0x03
Reserved	0x04
$\pi/2$ -BPSK (No Spreading)	0x05
Reserved for future use	0x06 to 0x1f
$\pi/2$ -BPSK with direct-sequence spreading	0x20 to 0x27
Reserved for future use	0x28 to 0x7f
User defined	0x80 to 0xff

- `P`, `Q0`, `Q1`, `Q2`, `Q3`, `Y_period`, `W_period`, `Y_pattern_bit`, `W_pattern_bit`, `scrambling_poly`: As per clause 6.4.6.4;
- `scrambling_init`: This 16-bit field defines the initial state of the shift register used to generate the scrambling sequence. The MSB corresponds to the initial value of the x^{16} bit; the LSB to the initial value of the x bit. When `scrambling_poly==0x0000`, this field is reserved;
- `preamble_len`: As per clause 6.4.6.4;
- `padding_len`: This 8-bit field specifies the number of pseudo-random padding chips inserted after the chips of the last block in the carrier frame. A value of 0 indicates no padding;
- `pilot_period`, `pilot_block_len`, `pilot_sum`: As per clause 6.4.6.4;
- `UW_length`: This is the length of the UW in chips or symbols. The UW length is implicitly given by the sum of `preamble_length`, `pilot_sum` and `postamble_length`;
- `UW_chip`: As per clause 6.4.6.4;
- `UW_symbol`: As per clause 6.4.6.1;
- `waveform_id`: As per clause 6.4.6.1.

6.4.6.4 Format Data Block for Spread-Spectrum LM Burst

The syntax of the data block providing the configuration for spread-spectrum linear modulation is specified in table 6-26.

Table 6-26: Syntax of the Data Block for the SS-TC-LM Transmission Format Class

Syntax	No. of bits		Mnemonic
	Reserved	Information	
ss_lm_data_block {			
tx_block_size		8	uimbsbf
threshold_ec_n0		8	uimbsbf
tx_start_offset	12	20	uimbsbf
if (tx_type > 127) {			
payload_size		16	uimbsbf
modulation_scheme		8	uimbsbf
P		8	uimbsbf
Q0	4	4	uimbsbf
Q1	4	4	uimbsbf
Q2	4	4	uimbsbf
Q3	4	4	uimbsbf
Y_period	3	5	uimbsbf
W_period	3	5	uimbsbf
for (j=0; j<Y_period; j++) {			
Y_pattern_bit		1	bslbf
while (!byte_aligned) {			
stuffing_bit		1	bslbf
}			
}			
for (j=0; j<W_period; j++) {			
W_pattern_bit		1	bslbf
while (!byte_aligned) {			
stuffing_bit		1	bslbf
}			
}			
scrambling_poly		16	uimbsbf
scrambling_init		16	uimbsbf
preamble_len		8	uimbsbf
postamble_len		8	uimbsbf
pilot_period	4	12	uimbsbf
pilot_block_len		8	uimbsbf
pilot_sum		16	uimbsbf
for (j=0; j<UW_length; j++) {			
UW chip		1	uimbsbf
}			
while (!byte_aligned) {			
stuffing_bit		1	bslbf
}			
else {			
waveform_id		8	uimbsbf
}			
}			

Semantics for the ss_lm_data_block:

- tx_block_size: The number of consecutive BTUs required for transmission of the physical layer block used by the specific TX type. This indicates the size of the timeslot required for the burst;
- threshold_ec_n0: This is the nominal sensitivity for the transmission type encoded as $(5 * \text{threshold}) + 120$ with the threshold given in dB and referred to a chip rate bandwidth. It serves as a reference for ACI control as specified in clause 7.3.8;
- tx_start_offset: A 20 bit field that gives the nominal offset for burst start from the start of the timeslot in units of NCR ticks. The maximum possible offset is approximately 22,7 ms;
- tx_type: This 8 bit field refers to the identifier of the transmission type. Values in the range 1-127 are reserved to refer to the reference bursts specified in annex A. Values in the range 128-255 are used by the NCC to specify waveforms;

- **payload_size:** This 16 bit field indicates the burst payload size in bytes. The value is the channel coding input block size;
- **modulation_scheme:** This is an 8-bit field which serves as an identifier of the modulation scheme as defined in table 6-27. When spread-spectrum transmission is employed, the three LSB of the field indicate the spreading factor as defined in table 6-28;

Table 6-27: Modulation Scheme Code Values

Modulation Scheme	Value
Reserved	0x00 to 0x04
$\pi/2$ -BPSK (No Spreading)	0x05
Reserved	0x06 to 0x1f
$\pi/2$ -BPSK with direct-sequence spreading	0x20 to 0x27
Reserved	0x28 to 0x7f
User defined	0x80 to 0xff

Table 6-28: Return link spreading factors

Spreading factor	Modulation Scheme LSB's
2	000
3	001
4	010
6	011
8	100
10	101
13	110
16	111

- **P:** This 8 bit field defines the permutation parameter P to be used for the specific burst type;
- **Q0, Q1, Q2 and Q3:** These 4-bit fields define the set of permutation parameters Q0-Q3 to be used for the specific burst type;
- **Y_period, W_Period:** These 5-bit fields specify the puncturing period for each of the parity bits Y and W, respectively;
- **Y pattern, W_pattern:** These 1-bit fields specify 1 bit in the contiguous sequence of bits specifying the puncturing pattern for each of the parity bits Y and W, respectively. A 1 indicates that the corresponding parity bit is to be kept, a 0 indicates that the bit is to be deleted (punctured);
- **stuffing_bit:** 0-7 stuffing bits that are used to align the preceding section with a byte boundary. The bits may take any value. These bits shall be discarded by the RCST;
- **scrambling_poly:** This 16-bit field contains the feedback polynomial of a binary shift-register sequence defining the scrambling sequence applied to the chips. The MSB corresponds to the coefficient of x^{16} , the LSB to the coefficient of x . The coefficient of x^0 is always 1. A value of 0x0000 indicates that the default scrambling sequence is used;
- **scrambling_init:** This 16-bit field defines the initial state of the shift register used to generate the scrambling sequence. The shift register is reset to this content before generation of the first scrambling bit of each burst. The MSB corresponds to the initial value of the x^{16} bit; the LSB to the initial value of the x bit. The generated bit sequence shall be the sequence of feedback bits. When applied to the chip sequence, a '1' shall indicate that the chip is not modified; a '0' shall indicate that the chip is inverted. When **scrambling_poly**==0x0000, this field is reserved;
- **preamble_length:** This 8 bit field specifies the preamble length in chips;
- **postamble_length:** This 8 bit field specifies the postamble length in chips;

- **pilot_period:** This 12 bit field specifies the insertion period of pilot blocks in chips. The last pilot chip of the first pilot block is positioned as the chip occurring a pilot_period after the last preamble chip. The pilot_period is also the distance between the first chip of two consecutive pilot blocks. A value of 0 indicates that no pilot chips are inserted;
- **pilot_block_length:** This 8 bit field indicates the number of chips in each block of pilots. If pilot_period=0, this field is reserved;
- **pilot_sum:** This 16 bit field specifies the total number of pilots to be inserted. If pilot_period=0 this field is reserved. If pilot_sum equals pilot_block then the construction represents a single midamble sequence. If pilot_sum is a multiple of pilot_block, then the construction represents multiple midamble sequences;
- **UW_length:** This is the length of the UW in chips. The UW length is implicitly given by the sum of preamble_length, pilot_sum and postamble_length;
- **UW_chip:** This 1 bit field specifies one chip in the concatenated sequence of preamble chips, pilot block chips and postamble chips. The bit specifies a chip to be transmitted, as defined in clauses 7.3.7.1.2 and 7.3.7.1.3;
- **waveform_id:** This 8 bit field refers to a reference waveform where some are specified in the present document in annex A.

6.4.7 The SPT and SAT-Content

6.4.7.0 Introduction

The SPT table described 6.4.7.1 provides information about satellite position and is typically designed for GSO systems. For satellite and system information including satellite ephemerides, cell and cell fragment definition, time association and beam-hopping time plan, the Satellite Access Table (SAT) specified in 6.4.7.2 shall be used.

6.4.7.1 The SPT Content

The SPT specified in table 6-29 conveys information about the positions of the satellites used for the forward and return links.

Table 6-29: Syntax of the Satellite Position Table Content

Syntax	No. of bits		Mnemonic
	Reserved	Information	
satellite_position_content(){			
satellite_loop_count		8	uimbsf
for(i=0;i<=satellite_loop_count;i++){			
satellite_id		8	uimbsf
x_coordinate		32	spfmsbf
y_coordinate		32	spfmsbf
z_coordinate		32	spfmsbf
}			
}			

Semantics for the satellite_position_content:

- **satellite_loop_count:** This 8 bit field indicates one less than the number of satellites specified in the loop. A zero count indicates one loop;
- **satellite_id:** This 8 bit field holds a system assigned satellite identifier;
- **x_coordinate:** This 32 bit field holds the x co-ordinate of the satellite ephemeris in meters;
- **y_coordinate:** This 32 bit field holds the y co-ordinate of the satellite ephemeris in meters;
- **z_coordinate:** This 32 bit field holds the z co-ordinate of the satellite ephemeris in meters.

NOTE: The position of the satellites will be expressed as Cartesian coordinates x, y, z in the geodetic reference frame ITRF96 (IERS Terrestrial Reference Frame). This system coincides with the WGS84 (World Geodetic System 84) reference system at the one meter level.

6.4.7.2 The SAT Content

Satellite ephemerides, cell and cell fragment definitions, time association and beam-hopping time plans, shall be delivered using the Satellite Access Table (SAT) as specified in EN 300 468 [3].

6.4.8 The CMT Content

The CMT content shall be as shown table 6-30. This table provides closed loop feedback to a number of RCSTs to allow them to adjust the transmit power level, frequency and burst timing as required to maintain the link conditions required at the receiver side.

Table 6-30: Syntax of the Correction Message Table Content

Syntax	No. of bits		Information Mnemonic
	Reserved	Information	
correction_message_table_content(){			
Entry_loop_count		8	uimsbf
for (i = 0; i <= Entry_loop_count; i++) {			
Group_ID		8	uimsbf
Logon_ID		16	uimsbf
Time_correction_flag		1	bslbf
Power_correction_flag		1	bslbf
Frequency_correction_flag		1	bslbf
Slot_Type		2	bslbf
Burst_time_scaling		3	uimsbf
If (Time_correction_flag == 1) {			
Burst_time_correction		8	tcimsbf
}			
If (Power_correction_flag == 1) {			
Power_control_flag		1	bslbf
If(Power_control_flag==1) {			
Power_correction		7	tcimsbf
}			
else {			
EsN0		7	tcimsbf
}			
If (Frequency_correction_flag == 1) {			
Frequency_correction		16	tcimsbf
}			
}			
}			

Semantics for the correction_message_table_content:

- **Entry_loop_count:** This field specifies one less than the number of correction message loops that follow. A zero count indicates one loop;
- **Group_ID:** This 8 bit field defines which Group ID the RCST is assigned to, as identified by the Terminal Information Message (TIM-U);
- **Logon_ID:** This 16 bit field identifies the assigned terminal logon identifier, as identified by the TIM-U;
- **Time_correction_flag; Power_correction_flag; Frequency_correction_flag; Slot_type; Burst_time_scaling; Burst_time_correction; Power_control_flag; Power_correction; EsN0; Frequency_correction:** These fields are identical to the corresponding fields of the Correction_message_descriptor, and defines one measurement correction set. See clause 6.4.17.1.

6.4.9 The TBTP2 Content

The terminal burst time plan table version 2 is specified in table 6-31.

Table 6-31: Syntax of the Terminal Burst Time Plan 2 Table Content

Syntax	No. of bits		Mnemonic
	Reserved	Information	
terminal_burst_time_plan_2_table_content() {			
group_id		8	uimsbf
superframe_sequence		8	uimsbf
assignment_context		8	uimsbf
superframe_count		8	uimsbf
assignment_format (AF)		8	uimsbf
frame_loop_count		8	uimsbf
for (i=0;i<=frame_loop_count;i++) {			
frame_number		8	uimsbf
assignment_offset		16	uimsbf
assignment_loop_count		16	uimsbf
for (j=0;j<=assignment_loop_count;j++) {			
If (AF=0) {			
assignment_id		48	uimsbf
}			
If (AF=1) {			
assignment_id		8	uimsbf
}			
If (AF=2) {			
assignment_id		16	uimsbf
}			
If (AF=3) {			
assignment_id		24	uimsbf
}			
If (AF=10) {			
dynamic_tx_type		8	uimsbf
assignment_id		8	uimsbf
}			
If (AF=11) {			
dynamic_tx_type		8	uimsbf
assignment_id		16	uimsbf
}			
If (AF=12) {			
dynamic_tx_type		8	uimsbf
assignment_id		24	uimsbf
}			
If (AF>127) {			
user_defined_format		nx8	see text
}			
}			
if content_size > table_header_size + (6 + SUMOF {5 + (assignment_loop_count [frame_loop] * loop_size[AF])} FOR ALL FRAMELOOPS in the table) {			
version_sum		8	uimsbf
reserved		nx8	
}			
}			

Semantics for the terminal_burst_time_plan_2_table_content:

- group_id: This 8 bit field refers the table either to one specific of the groups that RCSTs are assigned to, as identified for each at logon, or to all groups when set to zero;
- superframe_sequence: This is an 8-bit field which identifies a specific superframe sequence in the interactive network;

- **assignment_context:** This is an 8 bit field that indicates the context for the assignments in a TBTP2 instance, as shown in table 6-32;

Table 6-32: Coding of Assignment Context

Assignment Context ID	Assignment context type	Comment
0	All traffic contexts	Shall be parsed unconditionally (except for logon)
1	Transparent Star Traffic	
2	Logon	Dynamic resources for logon
3	Transparent Mesh Traffic	Resources for transparent mesh.
4	Continuous Carrier	Resources for continuous carriers
5 to 127		Reserved
> 127	User defined	

- a multi-context terminal should be capable of receiving independent assignments from several TBTP2s issued separately for the different contexts;
- **superframe_count:** This 8 bit field gives the modulo 256 of a superframe counter in the superframe sequence of the given SFS and refers to the superframe addressed by the TBTP, which is specifically the superframe that has a matching counter value and that is closest in time to the current NCR. For entries relating to continuous carriers, the start of the frame indicated by this field and **frame_number** is the time at which the assignment, change or revocation takes effect;
- **assignment_format:** This is an 8 bit field that indicates the assignment format. Unassigned values are reserved for future use;
- **frame_loop_count:** This 8-bit field indicates one less than the number of iterations in the frame loop;
- **frame_number:** This is an 8 bit field with an index identifying the specific frame by numbering the frames in the superframe by an ascending index starting at zero and ordering the frames first coarsely with ascending centre frequency of the lowest carrier frequency, then more granularly with ascending frame start time and finally incrementally with ascending frame type;
- **assignment_offset:** This is the offset in number of timeslots before the first iteration of the frame section loop. This supports sending a TBTP2 for a section of the superframe without aligning the TBTP2 edge to a frame border;
- **assignment_loop_count:** This 16-bit field indicates one less than the number of iterations in the assignment loop. The frame sections are addressed in the order lowest in frequency and first in time, incrementally according to ascending time and coarsely according to ascending frequency;
- **dynamic_tx_type:** This is an 8-bit field that indicates the BCT tx_type to be used in the timeslot, and a non-zero value refers to a specification in the BCT. The size of the timeslot is then implicitly given by the number of BTUs required by the tx_type. If **dynamic_tx_type** = 0 the corresponding timeslot is assumed to be associated to a non-zero tx_type by other means;
- when using the TBTP2 to determine the TX type, then the number of BTUs in an assignment, the MODCOD and the payload type are all determined by BCT lookup. This lookup is thus required by each RCST to determine the position of the first timeslot in the next iteration of the assignment loop;
- **assignment_id:** 8 bit, 16 bit, 24 bit or 48 bit field that indicates access method and may indicate the specific recipient of the assignment. The **assignment_id** is used as shown in table 6-33.

Table 6-33: Coding of the Assignment IDs

Assignment ID 48 bit	Assignment ID 24 bit	Assignment ID 16 bit	Assignment ID 8 bit	Access method
0xFFFFFFFFFFFF-n	0FFFFFFF-n	0xFFFF-n	0xFF-n	Upper range used for random access allocation channels
n-0x0000000000001	n-0x000001	n-0x0001	n-0x01	Lower range used for dedicated access allocation channels
0x000000000000	0x000000	0x0000	0x00	Void/not indicated

NOTE: n is implicitly given by allocation of assignment IDs.

NOTE: It is the responsibility of the NCC to assign transmission opportunities that apply for the given timeslot structure. The RCST may silently discard transmission opportunities that are found incompatible with the system state as dictated by the SCT, FCT2 and the BCT.

- `content_size`: the size of the table indicated by the L2 transport protocol;
- `table_header_size`: the table header size applicable for the L2 protocol in use - 4 bytes for GSE;
- `assignment_loop_count[frame_loop]`: the assignment count of a specific frame loop in the table;
- `loop_size[AF]`: the number of bytes in each assignment loop when using the indicated AF;
- `version_sum`: modulo-256 sum of the version numbers of the SCT, FCT2 and BCT that applies as reference for a specific TBTP2 instance. The `version_sum` shall be the first of any parameters appearing after completion of the loops.

6.4.10 The NIT Content

The NIT specified in table 6-34 provides information about the system in the format specified by ETSI EN 300 468 [3] and may hold the information needed to detect the presence of and determine the location of the interactive service. It may provide the information needed to locate the RMT specified in the present document. The network descriptors may include one Linkage Descriptor identifying the RCS map service. One multiplex stream specification then indicates a forward link multiplex for the RCS map service by use of a transport descriptor. The transport descriptor for the RCS map service is a Satellite Delivery System descriptor with the specification of the forward link multiplex that provides the RCS map service.

Table 6-34: Syntax of the Network Information Table Content

Syntax	No. of bits		Information Mnemonic
	Reserved	Information	
<code>network_information_table_content(){</code>			
<code>network_descriptors_length</code>	4	12	uimsbf
<code>for (i = 0; i < network_descriptors_length; i++) {</code>			
<code>network_descriptors_byte</code>		8	uimsbf
<code>}</code>			
<code>multiplex_streams_spec_length</code>	4	12	uimsbf
<code>for (i = 0; i < multiplex_streams_spec_length; i++) {</code>			
<code>multiplex_streams_spec_byte</code>		8	bslbf
<code>}</code>			
<code>}</code>			

Semantics for the `network_information_table_content`:

- `network_descriptors_length`: This 12 bit field specifies the number of bytes in the contiguous section of networks descriptors;
- `network_descriptors_byte`: This 8 bit field holds one byte of the contiguous sequence of bytes that constitutes a contiguous sequence of network descriptors;
- `multiplex_streams_spec_length`: This 12 bit field specifies the number of bytes in the contiguous section of stream specifications;
- `multiplex_streams_spec_byte`: This 8 bit field holds one byte of the contiguous sequence of bytes that constitutes a contiguous sequence of multiplex stream specifications each structured as specified in table 6-35.

Table 6-35: Syntax of the NIT Multiplex Stream Specification Content

Syntax	No. of bits		Information Mnemonic
	Reserved	Information	
multiplex_stream_specification_content(){			
forward_multiplex		16	uimbsf
original_network_id		16	uimbsf
transport_descriptors_length	4	12	uimbsf
for (i = 0; i < transport_descriptors_length; i++) {			
transport_descriptors_byte		8	uimbsf
}			
}			

Semantics for the network_information_table_content:

- forward_multiplex: This is a 16 bit field which serves as a label for identification of this multiplex across all multiplexes within the delivery system;
- original_network_id: This is a 16 bit field identifying the network ID of the originating delivery system;
- transport_descriptors_length: This 12 bit field specifies the number of bytes in the contiguous section of transport descriptors;
- transport_descriptors_byte: This 8 bit field holds one byte of the contiguous sequence of bytes that constitutes a contiguous sequence of transport descriptors.

6.4.11 The RMT Content

The RMT specified in table 6-36 holds the information required to locate the forward link multiplex and the return link multiplex to be used to connect to the interactive network. The network descriptors are one or more Linkage Descriptors. Each multiplex stream specification indicates a forward link multiplex or a return link multiplex associated with one of the specified Linkage Descriptors, by use of a transport descriptor. A transport descriptor is either a Satellite Forward Link descriptor for the specification of a forward link multiplex or a Satellite Return Link descriptor for the specification of a return link multiplex. An interactive service needs as a minimum one of each.

Table 6-36: Syntax of the RCS Map Table Content

Syntax	No. of bits		Information Mnemonic
	Reserved	Information	
RCS_map_table_content(){			
network_descriptors_length	4	12	uimbsf
for (i = 0; i < network_descriptors_length; i++) {			
network_descriptors_byte		8	uimbsf
}			
multiplex_streams_spec_length	4	12	uimbsf
for (i = 0; i < multiplex_streams_spec_length; i++) {			
multiplex_streams_spec_byte		8	bslbf
}			
}			

Semantics for the RCS_information_table_content:

- network_descriptors_length: This 12 bit field specifies the number of bytes in the contiguous section of network descriptors;
- network_descriptors_byte: This 8 bit field holds one byte of the contiguous sequence of bytes that constitutes a contiguous sequence of network descriptors;
- multiplex_streams_spec_length: This 12 bit field specifies the number of bytes in the contiguous section of stream specifications;

- `multiplex_streams_spec_byte`: This 8 bit field holds one byte of the contiguous sequence of bytes that constitutes a contiguous sequence of multiplex stream specifications each structured as specified in table 6-37;

Table 6-37: Syntax of the RMT Multiplex Stream Spec Content

Syntax	No. of bits		Information Mnemonic
	Reserved	Information	
<code>multiplex_stream_specification_content(){</code>			
<code>forward_multiplex</code>		16	<code>uimsbf</code>
<code>return_multiplex</code>		16	<code>uimsbf</code>
<code>transport_descriptors_length</code>	4	12	<code>uimsbf</code>
<code>for (i = 0; i < transport_descriptors_length; i++) {</code>			
<code>transport_descriptors_byte</code>		8	<code>uimsbf</code>
<code>}</code>			
<code>}</code>			

- `forward_multiplex`: This is a 16 bit field which serves to identify a specific multiplex across all multiplexes within the delivery system. It corresponds to the same identifier used in the linkage descriptor in the network descriptor section in the same RMT;
- `return_multiplex`: This is a 16 bit field identifying the return link multiplex. It corresponds to the same identifier used in the linkage descriptor in the network descriptor section in the same RMT;
- `transport_descriptors_length`: This 12 bit field specifies the number of bytes in the contiguous section of transport descriptors;
- `transport_descriptors_byte`: This 8 bit field holds one byte of the contiguous sequence of bytes that constitutes a contiguous sequence of transport descriptors.

6.4.12 The MMT2 Content

Table 6-38 specifies the Multicast Mapping Table 2 content syntax.

Table 6-38: Syntax of the Multicast Mapping Table 2 content

Syntax	No. of bits		Information Mnemonic
	Reserved	Information	
<code>mmt2_content(){</code>			
<code>svn_number</code>		16	<code>uimsbf</code>
<code>svn_prefix_size</code>	3	5	<code>uimsbf</code>
<code>pt_count</code>		8	<code>uimsbf</code>
<code>for(i=0;i<pt_count;i++) {</code>			
<code>protocol_type</code>		16	<code>uimsbf</code>
<code>address_size</code>		8	<code>uimsbf</code>
<code>mapping_sections</code>		8	<code>uimsbf</code>
<code>for(k=0;k<mapping_sections;k++) {</code>			
<code>inclusion_start</code>		<code>address_size</code>	<code>uimsbf</code>
<code>inclusion_end</code>		<code>address_size</code>	<code>uimsbf</code>
<code>exclusions</code>		8	<code>uimsbf</code>
<code>for(n=0;n<exclusions;n++) {</code>			
<code>exclusion_start</code>		<code>address_size</code>	<code>uimsbf</code>
<code>exclusion_end</code>		<code>address_size</code>	<code>uimsbf</code>
<code>}</code>			
<code>mac24_base</code>		24	<code>uimsbf</code>
<code>mcast_prefix_length</code>	3	5	<code>uimsbf</code>
<code>}</code>			
<code>}</code>			

Semantics for the `mmt2_content`:

- `svn_number`: a 16 bit field containing an SVN number with the prefix for which the following mapping applies;
- `svn_prefix_size`: A 5 bit field with a number in the range 1,...,16 that indicates the number of most significant bits of the SVN number that holds the SVN number prefix that refers to the set of SVNs for which this MMT2 applies;
- `pt_count`: an 8 bit field indicating the number of protocol types covered by this descriptor;
- `protocol_type`: a 16 bit field indicating a specific higher layer protocol type by its GSE type;
- `address_size`: an 8 bit field indicating the number of bytes used for the multicast address for the specific protocol type;
- `mapping_sections`: an 8 bit field indicating the number of sections mapping multicast addresses of the respective protocol type to MAC24 for the respective SVN number;
- `inclusion_start`: an *address_size* byte field that indicates the lowest address of the address range mapped in the respective mapping section;
- `inclusion_end`: an *address_size* byte field that indicates the highest address of the address range mapped in the respective mapping section;
- `exclusions`: an 8 bit field indicating the number of explicit exclusion sections from a mapping section;
- `exclusion_start`: an *address_size* byte field that indicates the lowest address of the respective contiguous address range excluded from the respective mapping section;
- `exclusion_end`: an *address_size* byte field that indicates the highest address of the respective contiguous address range excluded from the respective mapping section;
- `mac24_base`: a 24 bit field indicating the base MAC24 to be used for determining the RCS-MAC by synthesis in the respective mapping section;
- `mcast_prefix_length`: a 5 bit field that indicates the number of most significant bits of the `mac24_base` address that shall be copied to the multicast MAC24. The least significant bits shall be synthesized as for the same bit positions when mapping to Ethernet MAC for the specific protocol type, i.e. as specified in IETF RFC 1112 [11] for IPv4 and in IETF RFC 2464 [13] for IPv6.

6.4.13 The TMST2 Content

The Transmission Mode Support Table 2 specified in table 6-39 defines the DVB-S2(X) transmission modes supported by the network for forward link transmission. If the forward link is transmitted using DV-S2X or DVB-S2 in ACM mode, VCM mode or multi-stream in any mode, then this table shall be transmitted as part of the forward link signalling.

The table contains a loop over transmission mode definitions. MODCOD, pilot symbols and FECFRAME are as defined in ETSI EN 302 307-1 [2].

Table 6-39: Syntax of the Transmission Mode Support Table 2 (TMST2)

Syntax	No. of bits		Information Mnemonic
	Reserved	Information	
<code>transmission_mode_support_2_table_content() {</code>			
<code>common_system_margin</code>		8	uimsbf
<code>transmission_mode_count</code>		8	uimsbf
<code>for (i = 0; i < transmission_mode_count; i++) {</code>			
<code>frame_length</code>		2	bslbf
<code>pilot_symbols</code>		1	
<code>MODCOD</code>		5	bslbf
<code>modcod_system_margin</code>		8	tcimsbf
<code>ISI</code>		8	uimsbf

}			
if (transmission_standard == 3) {			
s2x_transmission_mode_count		8	uimsbf
for (i = 0; i < s2x_transmission_mode_count ; i++) {			
s2x_MODCOD		8	bslbf
modcod_system_margin		8	tcimsbf
ISI		8	uimsbf
}			
s2x_vlsnr_transmission_mode_count		8	uimsbf
for (i = 0; i < s2x_vlsnr_transmission_mode_count ; i++) {			
vlsnr_MODCOD	4	4	bslbf
modcod_system_margin		8	tcimsbf
ISI		8	uimsbf
}			
}			
NOTE: Transmission_standard is signalled in the Satellite Forward Link Descriptor (Satellite forward_link_v2 descriptor). For transmission_standard == 3, the S2 modcods shall either all be signalled in the first transmission_mode_count based loop or the s2x_transmission_mode_count based second loop.			

Semantics for the transmission_mode_support_2_table_content:

- common_system_margin: This 8-bit field specifies the required common system margin, in 0,1 dB steps. The RCST may add this value to its internal demodulation threshold values in order to allow for ACM control reaction time and other common factors outside its own control;
- transmission_mode_count: This is the number of iterations in the loop that follows. Each interaction describes one DVB-S2 transmission mode that is supported by the network;
- frame length: This field indicates the possible FECFRAME length applied with the transmission mode described by the iteration. "01" means short frames only, "10" means long frames only, "11" means both short and long frames, "00" is reserved;
- pilot_symbols: This field indicates the use of pilot symbols for the associated transmission mode. "1" means that pilot symbols are always used, "0" means that they are never used;
- MODCOD: This field indicates the modulation scheme for the transmission mode described by the iteration. The definition of values is the same as for the MODCOD parameter in the DVB-S2 standard;
- modcod_system_margin: This 8-bit field specifies the required system margin specific for this MODCOD, in 0,1 dB steps as a two's complement integer value. The RCST may add this value to its internal demodulation threshold values in order to compensate for modcod specific system degradation outside its own control;
- ISI: This field, if different from 0xFF, indicates a specific input stream identifier (ISI) of a specific PL frame stream carrying the frames with the corresponding MODCOD. It can be used to support the RCST in selection of streams in a multi-stream TDM. If ISI is 0xFF the specific MODCOD may be used for any input stream (ISI) assigned to the RCST;
- s2x_transmission_mode_count: This is the number of iterations in the loop that follows. Each interaction describes one DVB-S2X transmission mode that is supported by the network;
- s2x_MODCOD: This is a 8 bit field that contains b0-b1-b2-b3-b4-b5-b6-b7 (thus including symbols indication) of the modcod as described in clause 5.5.2 of ETSI EN 302 307-2 [16];
- s2x_vlsnr_transmission_mode_count: This is the number of iterations in the loop that follows. Each interaction describes one DVB-S2X VL-SNR transmission mode that is supported by the network;
- vlsnr_MODCOD: This is a 4 bit field that contains the index pointing to the VL-SNR modcod, 0x0 pointing to first MODCOD in the list shown in clause 5.5.2.5 of ETSI EN 302 307-2 [16]. Note that for VL-SNR pilots are always mandatory.

6.4.14 The TIM Content

The TIM shall be as defined in table 6-40.

Table 6-40: Syntax of the Terminal Information Message Content

Syntax	No. of bits		Information Mnemonic
	Reserved	Information	
terminal_information_message_content() {			
if (TIM-U) {			
RCST_Status		8	flagmsf
}			
else {			
Network_status		8	flagmsf
}			
descriptor_loop_count		8	uimsbf
for (i= 0; i<= descriptor_loop_count; i++) {			
descriptor()		see text	
}			
if (TIM-U) {			
Pad_bytes		see text	
}			
}			

Semantics for the terminal_information_message_section:

- RCST_Status: This 8 bit field gives status flags defining the network state of the RCST (see table 6-41).

Table 6-41: RCST Status in TIM-U

Bit	Identifier
(MSB) 7	ID_encrypt
6	Logon_fail_(busy)
5	Logon_denied
4	Log_off
3	Transmit_Disable
2	Rain_Fade_release
1	Rain_Fade_detect
(LSB) 0	Wake_up

Semantics for the flag bits are as follows, where a logic "1" asserts the condition defined:

- ID_encrypt: Indicates that the RCST shall use TBTP logon ID encryption;
- Logon_fail_(busy): Indicates that the RCST cannot enter the network because of lack of resources;
- Logon_denied: A '1' indicates that the RCST is not authorized to enter the network;
- Log_off: A '1' instructs the RCST to transition to the Off/Standby state if not in the Hold/Standby state;
- Transmit_Disable: A '1' instructs the RCST to proceed with operation in the Hold/Standby state when this bit is set to "1". A '0' instructs the RCST to leave the Hold/Standby state;
- Rain_Fade_release: A '1' indicates that the NCC is performing a reconfiguration procedure to restore settings following cessation of a rain fade event;
- Rain_Fade_detect: A '1' indicates that the NCC has detected a rain fade event and is performing a reconfiguration procedure to establish rain fade settings;
- Wake_up: A '1' instructs to the RCST to connect to the return link if it is proceeding to operate in the Off/Standby state or in the Ready for Logon state;
- Network_Status: This 8 bit field gives status flags defining the network state for RCSTs within the scope of the TIM-B. The flag bits are specified in table 6-42.

Table 6-42: Network Status in TIM-B

Bit	Identifier
(MSB) 7	Reserved ('0')
6	Reserved ('0')
5	Reserved ('0')
4	Reserved ('0')
3	Link_failure_recovery
2	Return_link_failure
1	Reserved ('0')
(LSB) 0	Reserved ('0')

Semantics for the flag bits are as follows, where "1" asserts the condition defined:

- Link_failure_recovery: A '1' indicates that the system is recovering from a failure of a forward or return link;
- Return_link_failure: A '1' indicates that the NCC has detected a failure of the return link;
- descriptor_loop_count: This 8 bit field defines one less than the number of descriptors in the following loop. A zero count indicates one loop;
- descriptor(): The descriptors that may be inserted into a TIM-U and a TIM-B are listed in clause 6.4.1;
- Pad_bytes: An 8 bit field. A number of Pad_bytes may be inserted so as to pad an encrypted portion of the message to the encryption block boundary. The content of this field may be randomized to prevent code spoofing.

6.4.15 The Fast Access Table Content (optional)

Table 6-43 is intended to support transport descriptors that are likely to change more often than the data carousel used for other broadcast tables can or is desired to support.

Table 6-43: Syntax of the Fast Access Table Content

Syntax	No. of bits		Information Mnemonic
	Reserved	Information	
fast_access_table_content() {			
descriptor_loop_count		8	uimsbf
for (i= 0; i<= descriptor_loop_count; i++) {			
descriptor()		see text	
}			
}			

Semantics for the terminal_information_message_section:

- descriptor_loop_count: This 8 bit field defines one less than the number of descriptors in the following loop. A zero count indicates one loop;
- descriptor(): The descriptors that may be inserted into a FAT are listed in clause 6.4.1.

6.4.16 Supplementary SI Tables Content (optional)

Other SI tables from the set specified in ETSI EN 300 468 [3] shall if used in the continuous generic stream be mapped into GSE based signalling as the SI tables specified in the present document. The content starting after the standard SI section header as identified by ETSI EN 301 790 [1] and up to the trailing CRC32 shall be mapped into the GSE table transport specified in the present document, similarly as done for the table content explicitly specified in the present document.

In a TS Packet stream these tables shall be formatted and sent as specified in ETSI EN 300 468 [3].

6.4.17 The Descriptors

6.4.17.0 Introduction

The syntax of each of the well-known descriptors is specified in clauses 6.4.17.1 to 6.4.17.17.

6.4.17.1 Correction Message Descriptor

The Correction Message descriptor defines a transmit parameter correction set for one terminal measurement. It shall be as defined in table 6-44.

Table 6-44: Syntax of the Correction Message Descriptor

Syntax	No. of bits		Information Mnemonic
	Reserved	Information	
Correction_message_descriptor(){			
descriptor_tag		8	uimsbf
descriptor_length		8	uimsbf
time_correction_flag		1	bslbf
power_section_flag		1	bslbf
frequency_correction_flag		1	bslbf
timeslot_content_type		2	bslbf
burst_time_scaling		3	uimsbf
if (time_correction_flag == 1) {			
burst_time_correction		8	tcimsbf
}			
if (power_section_flag == 1) {			
power_control_flag		1	bslbf
if(power_control_flag==1) {			
power_correction		7	tcimsbf
}			
else {			
EsN0		7	tcimsbf
}			
}			
If (frequency_correction_flag == 1) {			
Frequency_correction}		16	tcimsbf
}			

Semantics for the correction_message_descriptor:

- descriptor_tag: The descriptor tag is an 8 bit field which identifies the descriptor type. The value is given in table 6-2;
- descriptor_length: The descriptor length is an 8 bit field specifying the number of bytes of the descriptor immediately following the descriptor_length field;
- time_correction_flag, Power_section_flag, and Frequency_correction_flag: These three bits are used to indicate the presence of time, power and frequency correction fields, respectively, in the remainder of the descriptor;
- timeslot_content_type: This 2 bit field identifies the content type of the burst being measured, as defined in table 6-45;

Table 6-45: Timeslot Content type

Value	Identifier
00	Traffic
01	Logon
10	Reserved
11	Control

- **burst_time_scaling**: This 3 bit field gives the power-of-2 scaling to apply to the **Burst_time_correction** parameter, i.e. a value of 2 indicates a scaling factor of 4 (= shift left 2 bits). In case there is no time correction in this descriptor, i.e. the **Time_correction_flag** is equal to 0; the **Burst_time_scaling** field is set to 000;
- **burst_time_correction**: This 8 bit field gives the required correction to burst timing as a two's complement binary NCR clock count (i.e. in counts of the 27 MHz NCR clock) that is scaled according to the **Burst_time_scaling** field above;
- **power_control_flag**: This 1 bit field indicates the content of the following 7 bits. The value "1" indicates that the NCC transmits a power correction value for the RCST and the value "0" indicates that the NCC transmits a measured E_s/N_0 value instead;
- **power_correction**: This 7 bit field indicates the required correction to uplink power on the return link in 0,5 dB steps as a two's complement integer value;
- **EsNO**: This 7 bit field gives the measured E_s/N_0 value on the return link in 0,5 dB steps as two's complement integer value. E_s/N_0 is the energy per transmitted symbol, divided by the spectral density of noise and interference;
- **frequency_correction**: This 16 bit field gives the required correction to frequency in 10 Hz steps, as a two's complement integer value. A negative value indicates that the terminal is required to reduce the frequency. For systems not implementing frequency correction, this field is set to all 0 s.

6.4.17.2 Control Assign Descriptor

This descriptor (table 6-46) provides the semi-static BTP assignment of control timeslots as well as thresholds for achieving fine synchronization. It is typically sent following the detection of a valid logon burst from the terminal and may also be sent when it is necessary to modify the assigned control timeslot sequence or the thresholds for TDMA sync supervision.

Table 6-46: Syntax of the Control Assign Descriptor

Syntax	No. of bits		Information Mnemonic
	Reserved	Information	
control_assign_descriptor() {			
descriptor_tag		8	uimsbf
descriptor_length		8	uimsbf
sync_achieved_time_threshold		8	uimsbf
max_sync_tries		8	uimsbf
sync_achieved_frequency_threshold		16	uimsbf
control_start_superframe_count		16	uimsbf
control_frame_number		8	uimsbf
control_repeat_period		16	uimsbf
control_timeslot_number	5	11	uimsbf
}			

Semantics for the control_assign_descriptor:

- **descriptor_tag**: The descriptor tag is an 8 bit field which identifies the descriptor type. The value is given in table 6-2;
- **descriptor_length**: The descriptor length is an 8 bit field specifying the number of bytes of the descriptor immediately following the descriptor_length field;
- **sync_achieved_time_threshold**: This 8 bit field gives if the value is different from zero the maximum magnitude the burst timing offset associated with being in the fine synch state;
- **max_sync_tries**: This 8 bit field gives the maximum number of bursts that the RCST may transmit to achieve fine synchronization, before having to give up the attempt;
- **sync_achieved_frequency_threshold**: This 16 bit field gives if different from zero the maximum magnitude of the carrier frequency error associated with being in the fine synch state;

- control_start_superframe_count: This 16 bit field gives in advance the superframe_count value for the superframe in which the first timeslot of the assignment appears;
- control_frame_number: This 8 bit field identifies which frame number in the superframe that contains the control timeslot. This number refers to the frame numbering defined for the superframe;
- control_repeat_period: This 16 bit field gives the number of superframes between assigned control timeslots, for example, control_repeat_period=0 means that the control timeslot is assigned in each superframe, control_repeat_period=1 means that two superframes containing the control timeslot assignment are separated by 1 superframe that does not have the control timeslot assigned, and so on;
- control_timeslot_number: This 11 bit field identifies the timeslot number to use for the control burst. This number refers to the timeslot numbering defined for the frame.

6.4.17.3 Echo Value Descriptor

This descriptor (table 6-47) supports a simple loop-back RCST diagnostic test.

Table 6-47: Syntax of the Echo Value Descriptor

Syntax	No. of bits		Information Mnemonic
	Reserved	Information	
echo_value_descriptor() {			
descriptor_tag		8	uimsbf
descriptor_length		8	uimsbf
echo_value		16	bslbf
}			

Semantics for the echo_value_descriptor:

- descriptor_tag: The descriptor tag is an 8 bit field which identifies the descriptor type. The value is given in table 6-2;
- descriptor_length: The descriptor length is an 8 bit field specifying the number of bytes of the descriptor immediately following the descriptor_length field;
- echo_value: This 16 bit field defines the value to be echoed back (for example in the 2 M&C bytes of the return link control PDU). The MSB is set to "1".

6.4.17.4 Linkage Descriptor

This descriptor specified in table 6-48 supports the RCST in identifying and locating the interactive network services for its population group identified by the Population ID assigned to the RCST in advance of connecting to the network.

Table 6-48: Syntax of the Linkage Descriptor

Syntax	No. of bits		Information Mnemonic
	Reserved	Information	
linkage_descriptor(){			
descriptor_tag		8	uimsbf
descriptor_length		8	uimsbf
forward_multiplex		16	uimsbf
if (NIT) {			
original_network_id		16	uimsbf
}			
else {			
return_multiplex		16	uimsbf
}			
service_id		16	uimsbf
linkage_type		8	uimsbf
if (RMT) {			
interactive_network_id		16	uimsbf
population_id_loop_count		8	uimsbf

Syntax	No. of bits		Information Mnemonic
	Reserved	Information	
for (i=0; i<=population_id_loop_count; i++) {			
population_id_base		16	uimsbf
population_id_mask		16	uimsbf
}			
for (i=0; i<N; i++) {			
private_data_byte		8	bslbf
}			
}			

Semantics for the linkage_descriptor:

- descriptor_tag: The descriptor tag is an 8 bit field which identifies the descriptor type. The value is given in table 6-2;
- descriptor_length: The descriptor length is an 8 bit field specifying the number of bytes of the descriptor immediately following the descriptor_length field;
- forward_multiplex: This is a 16-bit field which identifies the forward multiplex containing the information service indicated;
- original_network_id: This 16-bit field gives the label identifying the network_id of the originating delivery system of the information service indicated;
- return_multiplex: This is a 16-bit field which identifies the return multiplex containing the information service indicated;
- service_id: This is a 16-bit field which uniquely identifies an information service within a multiplex. It may be ignored when the forward_multiplex does not refer to a TS packet stream;
- linkage_type: This is an 8-bit field specifying the type of linkage. Its value is in the RMT 0x81 for a TS Packet based "FLS" service and 0x82 for a GSE Packet based "FLS" service, and in NIT it is 0x07 for the "RCS Map" service;
- interactive_network_id: This 16 bit field gives the label identifying the Network ID for the Interactive Network that services the population_IDs following;
- population_id_loop_count: This 8 bit field indicates one less than the number of Population ID ranges in the following list;
- population_id_base and population_id_mask: These two 16 bit values, in combination, define together a range of Population IDs associated with this linkage descriptor. The Population ID is the identifier for the population that the RCST belongs to. This is a parameter known to the RCST prior to forward link acquisition. The population_id_base parameter defines the fixed bit pattern part of the Population ID range, while the population_id_mask parameter defines those bit positions of the Population ID that are selective. A "1" value in a bit of the mask indicates that the corresponding bit of the RCST Population ID matches the range unconditionally. A "0" value in a bit of the mask indicates that the corresponding bit of the RCST Population ID shall match the value of that bit in the population_id_base parameter in order to declare a match;
- private_data_byte: This is an 8 bit field, the value of which is privately defined. It retains the functionality of the linkage_descriptor for further extensions.

6.4.17.5 Satellite Return Link Descriptors

6.4.17.5.0 Introduction

There are 2 possibilities to describe the Satellite return link. The first is by using the Satellite Return Link Descriptor of 6.4.17.5.1 and the second is Satellite_return_link_v2_descriptor 6.4.17.5.2.

When the SAT table (6.4.7.2) is used to obtain satellite position information then the `Satellite_return_link_v2_descriptor` shall be used.

When the `Satellite_return_link_v2_descriptor` is used then SAT table (6.4.7.2) shall be signalled to provide satellite position information.

Transponders which require the `Satellite_return_link_v2_descriptor` (e.g. non-geostationary satellites) will exclude older receivers. Existing receivers where support of these transponders is wanted, will have to add support for the `Satellite_return_link_v2_descriptor`, otherwise the transponders will be ignored.

For transponders compatible with the `Satellite_Return_Link_descriptor`, using that descriptor will allow to include the receivers that do not support `Satellite_return_link_v2_descriptor`.

In order to support receivers that don't support the `Satellite_return_link_v2_descriptor`, the `Satellite_return_Link_descriptor` shall be used.

6.4.17.5.1 Satellite Return Link Descriptor

The satellite return link descriptor defines the characteristics of the return link and is specified in table 6-49.

Table 6-49: Syntax of the Satellite return link descriptor

Syntax	No. of bits		Information Mnemonic
	Reserved	Information	
<code>Satellite_return_link_descriptor() {</code>			
<code>descriptor_tag</code>		8	uimsbf
<code>descriptor_length</code>		8	uimsbf
<code>satellite_ID</code>		8	uimsbf
<code>beam_ID</code>		16	uimsbf
<code>gateway_ID</code>		8	uimsbf
Reserved	5		bslbf
<code>allow_extended_lower_layer_capabilities</code>		1	bslbf
<code>no_linear_support</code>		1	bslbf
<code>no_cpm_support</code>		1	bslbf
<code>orbital_position</code>		16	bslbf
<code>west_east_flag</code>	7	1	bslbf
<code>superframe_sequence</code>		8	uimsbf
if (TIM-U) {			
<code>Tx_frequency_offset</code>		24	tcimsbf
}			
else {			
<code>zero_frequency_offset</code>		24	tcimsbf
}			
for (i=0; i<N; i++) {			
<code>private_data_byte</code>		8	bslbf
}			
}			

Semantics for the `Satellite_return_link_descriptor`:

- `descriptor_tag`: The descriptor tag is an 8 bit field which identifies the descriptor type. The value is given in table 6-2;
- `descriptor_length`: The descriptor length is an 8 bit field specifying the number of bytes of the descriptor immediately following the `descriptor_length` field;
- `satellite_ID`: This 8 bit field identifies which satellite is carrying the return link, and corresponds to the `satellite_ID` field in the SPT and in the Transmission Offset Descriptor;
- `beam_ID`: This 16 bit field identifies the beam number of the satellite carrying the return link;
- `gateway_ID`: This 8 bit field identifies which Gateway is receiving the return link, and corresponds to the `gateway_ID` field in the Transmission Offset Descriptor;

- `allow_extended_lower_layer_capabilities`: This 1 bit field indicates if this `lower_layer_capabilities` may be extended. Value '0' indicates lower layer capabilities shall not be extended, Value '1' indicates lower layer capabilities may be extended;
- `no_linear_support`: This 1 bit field indicates if this satellite return link does not support linear modulation. '0' indicates linear modulation may be supported, '1' indicates linear modulation is not supported;
- `no_cpm_support`: This 1 bit field indicates if this satellite return link does not support cpm modulation. '0' indicates cpm modulation may be supported, '1' indicates cpm modulation is not supported;
- `orbital_position`: The `orbital_position` is a 16 bit field giving the 4-bit BCD values specifying 4 characters of the orbital position in degrees where the decimal point is after the third character (e.g. 019,2°);
- `west_east_flag`: The `west_east_flag` is a 1 bit field indicating if the satellite position is in the western or eastern part of the orbit. A value "0" indicates the western position and a value "1" indicates the eastern position;
- `superframe_sequence`: This 8 bit field identifies the superframe sequence the RCST uses to logon to the interactive network and corresponds to a superframe sequence specification in the SCT;
- `Tx_frequency_offset`: This 24-bit field gives the signed offset of the RCST transmit centre frequency relative to the `Superframe_centre_frequency` parameter (SCT). The frequency is given in multiples of 100 Hz;
- `zero_frequency_offset`: This 24-bit field has the value zero;
- `private_data_byte`: This is an 8 bit field, the value of which is privately defined. It can be used, for example, to indicate system specific NCC information.

6.4.17.5.2 Satellite Return Link v2_Descriptor

The Satellite return link v2_descriptor defines the characteristics of the return link and is specified in table 6-49a.

Table 6-50a: Syntax of the Satellite return link v2_descriptor

Syntax	No. of bits		Information Mnemonic
	Reserved	Information	
Satellite_return_link_v2_descriptor() {			
descriptor_tag		8	uimsbf
descriptor_length		8	uimsbf
satellite_ID		24	uimsbf
beam_ID		16	uimsbf
gateway_ID		8	uimsbf
Reserved_zero_future_use	5		bslbf
allow_extended_lower_layer_capabilities		1	bslbf
no_linear_support		1	bslbf
no_cpm_support		1	bslbf
superframe_sequence		8	uimsbf
if (TIM-U) {			
Tx_frequency_offset		24	tcimsbf
}			
else {			
zero_frequency_offset		24	tcimsbf
}			
for (i=0; i<N; i++) {			
private_data_byte		8	bslbf
}			
}			

Semantics for the `Satellite_return_v2_link_descriptor`:

- `descriptor_tag`: As defined in section 6.4.17.5.1;
- `descriptor_length`: As defined in section 6.4.17.5.1;

- `satellite_ID`: This 24 bit field identifies which satellite is carrying the return link, and corresponds to the `satellite_ID` field in the SAT and in the `Transmission_Offset v2_Descriptor`;
- `beam_ID`: As defined in section 6.4.17.5.1;
- `gateway_ID`: As defined in section 6.4.17.5.1;
- `Reserved_zero_future_use`: This value may be used in the future for ETSI defined extensions. All `reserved_zero_future_use` bits are set to 0b0
- `allow_extended_lower_layer_capabilities`: As defined in section 6.4.17.5.1;
- `no_linear_support`: As defined in section 6.4.17.5.1;
- `no_cpm_support`: As defined in section 6.4.17.5.1;
- `superframe_sequence`: As defined in section 6.4.17.5.1;
- `Tx_frequency_offset`: As defined in section 6.4.17.5.1;
- `zero_frequency_offset`: As defined in section 6.4.17.5.1;
- `private_data_byte`: As defined in section 6.4.17.5.1.

6.4.17.6 Satellite Forward Link Descriptors

6.4.17.6.0 Introduction

When DVB Satellite Framing and Modulation, Second Generation Extensions (DVB-S2X) modulation as defined in ETSI EN 302 307-2 [16] is used, there are 2 possibilities to describe the Satellite forward link. The first is by using the `Satellite_forward_Link_Descriptor` (6.4.17.6.1) or the `Satellite_forward link_v2_descriptor` (6.4.17.6.2).

When satellite ephemerides are used (e.g. for non-GSO satellites), or when the transponder uses waveforms specified in Annex E of [16] (e.g. in a beamhopping mode) then the `Satellite_forward link_v2_descriptor` shall be used.

When the `Satellite_forward link_v2_descriptor` is used then SAT table (6.4.7.2) shall be signalled to provide satellite and system position information.

Transponders which require the `Satellite_forward link_v2_descriptor` (e.g. non-geostationary satellites) will exclude older receivers. Existing receivers where support of these transponders is wanted, will have to add support for the `Satellite_forward link_v2_descriptor`, otherwise the transponders will be ignored.

For transponders compatible with the `Satellite_forward Link_descriptor`, using that descriptor will allow to include the receivers that do not support `Satellite_forward link_v2_descriptor`.

In order to support receivers that don't support the `Satellite_forward link_v2_descriptor`, the `Satellite_forward link_descriptor` shall be used.

6.4.17.6.2 Satellite Forward Link Descriptor

The satellite forward link descriptor locates and specifies a forward link, and is used in place of the Satellite Delivery System descriptor of ETSI EN 300 468 [3] for RCS systems. It is shown in table 6-51.

Table 6-51: Syntax of the Satellite Forward Link descriptor

Syntax	No. of bits		Information Mnemonic
	Reserved	Information	
<code>Satellite_forward_link_descriptor()</code> {			
<code>descriptor_tag</code>		8	uimbsf
<code>descriptor_length</code>		8	uimbsf
<code>satellite_ID</code>		8	uimbsf
<code>beam_ID</code>		16	uimbsf

Syntax	No. of bits		Information Mnemonic
	Reserved	Information	
NCC_ID		8	uimsbf
multiplex_usage		3	bslbf
local_multiplex_ID		5	uimsbf
frequency		32	uimsbf
orbital_position		16	bslbf
west_east_flag		1	bslbf
Polarization		2	bslbf
transmission_standard		2	uimsbf
if (transmission_standard == 0) {			
"001"		3	bslbf
}			
else if ((transmission_standard == 1) or (transmission_standard == 2)) {			
scrambling sequence selector		1	bslbf
roll_off		2	uimsbf
}			
else if (transmission_standard == 3) {			
S2X_mode		3	uimsbf
}			
symbol_rate		24	uimsbf
if (transmission_standard == 0){			
FEC_inner		4	bslbf
Reserved	4		bslbf
}			
else if ((transmission_standard == 1) or (transmission_standard == 2)) {			
Input_Stream_Identifier		8	uimsbf
if (scrambling_sequence_selector == 0)			
reserved for forward link spreading		3	bslbf
scrambling_sequence_index	3	18	uimsbf
}			
}			
else if (transmission_standard == 3) {			
Input_Stream_Identifier		8	uimsbf
NCR_v2	3	1	bslbf
scrambling sequence selector		1	bslbf
S2X_roll_off		3	uimsbf
if (scrambling_sequence_selector == 0)			
reserved for forward link spreading		3	bslbf
scrambling_sequence_index	3	18	uimsbf
}			
if (S2X_mode == 2)			
timeslice_number		8	uimsbf
}			
}			
for (i=0; i<N; i++) {			
private_data_byte		8	bslbf
}			
}			

Semantics for the Satellite_forward_link_descriptor:

- descriptor_tag: The descriptor tag is an 8 bit field which identifies the descriptor type. The value is given in table 6-2;
- descriptor_length: The descriptor length is an 8 bit field specifying the number of bytes of the descriptor immediately following the descriptor_length field;
- satellite_ID: This 8 bit field identifies which satellite is carrying the forward link, and corresponds to the satellite_ID field in the SPT and in the Transmission Offset Descriptor;
- beam_ID: This 16 bit field identifies the beam number of the satellite carrying the forward link;

- **NCC_ID:** This 8 bit field identifies which NCC is transmitting the forward link, and corresponds to the NCC_ID field in the Transmission Offset Descriptor;
- **multiplex_usage:** This 3 bit field allows link discrimination for RCSTs that can operate on multiple forward link multiplexes simultaneously. The usage codes are shown in table 6-52;

Table 6-52: Forward Link Multiplex Usage Codes

Usage code	Value
000	Combined signalling/data multiplex
001	Signalling multiplex only
010	Data multiplex only
111	Release data multiplex only
011 to 110	Reserved for future use

- **local_multiplex_id:** This 5 bit field is used to simplify changes to the definition of a link for RCSTs that can operate on multiple forward link multiplexes simultaneously, and is a RCS local value defined by the interactive network operator. It allows the NCC to indicate which of the forward links is being created, modified or released. The last two operations can only be performed via TIM-U;
- **frequency:** This 32-bit field gives the frequency value. The frequency is given in multiples of 100 Hz;
- **orbital_position:** The orbital_position is a 16 bit field giving the 4-bit BCD values specifying 4 characters of the orbital position in degrees where the decimal point is after the third character (e.g. 019,2°);
- **west_east_flag:** The west_east_flag is a 1 bit field indicating if the satellite position is in the western or eastern part of the orbit. A value "0" indicates the western position and a value "1" indicates the eastern position;
- **polarization:** The polarization is a 2 bit field specifying the polarization of the transmitted signal (see table 6-53);

Table 6-53: Forward Link Polarization

Polarization	Value
linear - horizontal	00
linear - vertical	01
circular - left	10
circular - right	11

- **transmission_standard:** 0 for DVB-S, 1 for DVB-S2 using CCM, 2 for DVB-S2 using ACM and 3 for DVB-S2X;
- **scrambling sequence selector:** Value 1 means default DVB-S2(X) physical layer scrambling sequence of index 0, value 0 means that the scrambling sequence to be used is specified using the scrambling_sequence_index field;
- **roll_off:** 0 for not defined, 1 for 20 %, 2 for 25 %, 3 for 35 %;
- **S2X_mode:** The S2X_mode is a 3 bit field indicating in which DVB-S2X mode the stream is operated. It shall be coded according to table 6-54;

Table 6-54: S2X_mode

S2X_mode	Description
0	reserved for future use
1	S2X
2	S2X + timeslicing
3 to 7	reserved for future use

- **symbol_rate:** The symbol_rate is a 24 bit field giving the symbol rate in multiples of 100 symbols/s;

- FEC_inner: The FEC_inner is a 4 bit field specifying the inner FEC scheme used, as per table 6-55;

Table 6-55: Inner FEC Scheme

Code Rate	Value
1/2	0000
2/3	0001
3/4	0010
5/6	0011
7/8	0100
Inner code is omitted	1111
Reserved for future use	0101 to 1110

- Input_Stream_Identifier: As defined in ETSI EN 302 307-1 [2];
- scrambling_sequence_index: DVB-S2(X) physical layer scrambling sequence index as defined in ETSI EN 302 307-1 [2];
- NCR_v2: This is a 1 bit field, indicating with which NCR version the forward link is operated. Value '0' indicates the NCRv1 or the backwards compatible NCR version is in use. Value '1' indicates the NCRv2 is in use. Details of NCR/NCRv2 can be found in clause 6.2.1;
- S2X_roll_off: The S2X_roll_off is a 3 bit field indicating the roll-off factor used in DVB-S2X. It shall be coded according to table 6-56;

Table 6-56: S2X_roll_off

S2X roll off	Description
0	$\alpha = 0,35$
1	$\alpha = 0,25$
2	$\alpha = 0,20$
3	reserved for future use
4	$\alpha = 0,15$
5	$\alpha = 0,10$
6	$\alpha = 0,05$
7	reserved for future use

- timeslice_number: This 8-bit field indicates which timeslice number carries all data for the forward link being described;
- private_data_byte: This is an 8 bit field, the value of which is privately defined. It can be used, for example, to indicate system specific NCC information.

6.4.17.6.3 Satellite Forward Link_v2 Descriptor

For Satellite ephemerides (e.g. non-GSO satellites) and for systems that support Annex E of [16], ~~and those that support SAT table~~ the satellite forward link descriptor locates and specifies a forward link, and it uses additional parameters in addition of the S2Xv2 Satellite Delivery System descriptor of ETSI EN 300 468 [3]. It is shown in table 6-51a.

Table 6-57a: Syntax of the Satellite Forward Link v2 descriptor

Syntax	No. of bits		Information Mnemonic
	Reserved	Information	
Satellite_forward_link_v2_descriptor() {			
descriptor_tag		8	uimbsf
descriptor_length		8	uimbsf
beam_ID		16	uimbsf
NCC_ID		8	uimbsf
multiplex_usage		3	bslbf
local_multiplex_ID		5	uimbsf
S2Xv2_satellite_delivery_system_info_length		8	uimbsf
S2Xv2_satellite_delivery_system_info()			

Syntax	No. of bits		Information Mnemonic
	Reserved	Information	
for (i=0; i<N; i++) {			
private_data_byte		8	bslbf
}			
}			

- descriptor_tag: As defined in 6. 4.17.6.1;
- descriptor_length: As defined in 6. 4.17.6.1;
- beam_ID: As defined in 6. 4.17.6.1;
- NCC_ID: As defined in 6. 4.17.6.1;
- multiplex_usage: As defined in 6. 4.17.6.1;
- local_multiplex_id: As defined in 6. 4.17.6.1;
- S2Xv2_satellite_delivery_system_info_length: This 8-bit field specifies the length of the S2Xv2_satellite_delivery_system_info following it.
- private_data_byte: As defined in 6. 4.17.6.1;
- S2Xv2_satellite_delivery_system_info() : As specified in Table 144b: S2Xv2 satellite delivery system info of EN 300 468 [3] introduced in version v1.18.1 .

6.4.17.7 Logon Contention Descriptor

The Logon Contention Descriptor specified in table 6-58 indicates the retransmission control parameters for the random access logon bursts.

Table 6-58: Syntax of the Logon Contention Descriptor

Syntax	No. of bits		Information Mnemonic
	Reserved	Information	
logon_contention_descriptor(){			
descriptor_tag		8	uimsbf
descriptor_length		8	uimsbf
Superframe_sequence		8	uimsbf
Logon_response_timeout		32	ncvmsbf
Logon_max_losses		8	uimsbf
Max_time_before_retry		32	ncvmsbf
}			

Semantics for the logon_contention_descriptor:

- descriptor_tag: The descriptor tag is an 8 bit field which identifies the descriptor type. The value is given in table 6-2;
- descriptor_length: The descriptor length is an 8 bit field specifying the number of bytes of the descriptor immediately following the descriptor_length field;
- superframe_sequence: This is an 8-bit field which serves as a label for identification of the relevant superframe to which this descriptor applies;
- logon_response_timeout: This 32-bit field gives the timeout period after which the RCST considers that a transmitted logon burst was not received if no logon response has yet arrived. It is expressed in number of NCR ticks. The 32 bits correspond to a maximum timeout period of 93,2 s;

- `logon_max_losses`: This 8-bit field specifies the number of consecutive non-responded logon request transmissions after which the RCST considers the logon unsuccessful;
- `max_time_before_retry`: This 32-bit field gives the upper bound on the randomization interval for issuing a new logon burst after a lost logon burst, expressed in terms of NCR ticks. The 32 bits correspond to a maximum upper bound of 93,2 s.

6.4.17.8 Correction Control Descriptor

The Correction Control Descriptor (see table 6-59) indicates the timeouts for the fine synchronization and synchronization maintenance procedures.

Table 6-59: Syntax of the Correction Control Descriptor

Syntax	No. of bits		Information Mnemonic
	Reserved	Information	
<code>correction_control_descriptor(){</code>			
<code>descriptor_tag</code>		8	uimsbf
<code>descriptor_length</code>		8	uimsbf
<code>control_response_timeout</code>	32	32	ncvmsbf
<code>control_max_losses</code>	8	8	uimsbf
<code>}</code>			

Semantics for the `correction_control_descriptor`:

- `descriptor_tag`: The descriptor tag is an 8 bit field which identifies the descriptor type. The value is given in table 6-2;
- `descriptor_length`: The descriptor length is an 8 bit field specifying the number of bytes of the descriptor immediately following the `descriptor_length` field;
- `control_response_timeout`: This 32-bit field gives the value of the timeout period after which the RCST assumes that the control burst was not received. It is expressed in terms of NCR ticks. The 32 bits correspond to a maximum duration of 93,2 s;
- `control_max_losses`: This 8-bit field indicates the number of consecutive dedicated access control bursts sent without receiving response that implicitly determines loss of return link synch.

6.4.17.9 Mobility Control Descriptor

This descriptor (table 6-60) supports conveying of mobility-related commands to the RCST.

Table 6-60: Syntax of the Mobility Control Descriptor

Syntax	No. of bits		Information Mnemonic
	Reserved	Information	
<code>Mobility_control_descriptor() {</code>			
<code>descriptor_tag</code>		8	uimsbf
<code>descriptor_length</code>		8	uimsbf
<code>Command_value</code>		16	uimsbf
<code>Command_parameter</code>		16	See text
<code>}</code>			
NOTE: Reserved bits are of type bslbf, and shall precede the Information bits on the same line. They shall be ignored by the RCST. For an encrypted uni-cast TIM, the bit values shall be varied in a random manner to avoid encryption spoofing.			

Semantics for the `Mobility_control_descriptor`:

- `descriptor_tag`: The descriptor tag is an 8 bit field which identifies each descriptor. Its value is given in the Tag value column of table 6-2;

- **descriptor_length:** The descriptor length is an 8 bit field specifying the number of bytes of the descriptor immediately following the descriptor_length field;
- **command_value:** This 16 bit field specifies a mobility-related command to be carried out by the RCST, as defined in table 6-61;
- **command_parameter:** This 16 bit field allows the specification of parameters pertaining to specific values of Command_value, as defined in table 6-61.

Table 6-61: Mobility command and parameter values

Action Requested	Value	Parameter
No command	0x0000	Reserved
Execute forward and return link handover	0x0001	Reserved
Execute forward link handover	0x0002	Reserved
Execute return link handover	0x0003	Reserved
Reserved	0x0004	Reserved
Send transmitter status report	0x0005	Reserved
Send position report	0x0006	Reserved
Maximum NCR absence time without enforcing initial synchronization procedure	0x0007	Maximum allowed time; see below.
Reserved	0x0008 to 0x8FFF	
User defined	0x9000 to 0xFFFF	
NOTE: The time is indicated in seconds; the format is uimbsf. A value of 0 indicates that the RCST shall unconditionally carry out the initial sync procedure before logging on following a log-off.		

6.4.17.10 Correction Message Extension Descriptor

This descriptor specified in table 6-62 supports conveying to the RCST of the identification of the timeslot in which a logon burst is received.

Table 6-62: Syntax of the Correction Message Extension Descriptor

Syntax	No. of bits		Information Mnemonic
	Reserved	Information	
correction_message_extension_descriptor(){			
descriptor_tag		8	uimbsf
descriptor_length		8	uimbsf
superframe_sequence		8	uimbsf
superframe_count		16	uimbsf
frame_number		8	uimbsf
slot_number		16	uimbsf
}			

Semantics for correction_message_extension descriptor:

- **descriptor_tag:** The descriptor tag is an 8 bit field which identifies the descriptor type. The value is given in table 6-2;
- **descriptor_length:** The descriptor length is an 8 bit field specifying the number of bytes of the descriptor immediately following the descriptor_length field;
- **superframe_sequence:** This is an 8-bit field identifies the superframe sequence in which the logon burst was detected and to which the accompanying Correction Message Descriptor applies;
- **superframe_count:** This 16 bit field indicates within the superframe sequence the superframe count value of the superframe where the logon burst was detected and to which the Correction Message Descriptor applies;
- **frame_number:** This 8 bit field indicates within the superframe the number of the frame where the logon burst was detected and to which the accompanying Correction Message Descriptor applies. This number follows the numbering scheme defined in clause 7.5.1.1;

- `slot_number`: This 16 bit field indicates within the frame the number of the timeslot where the logon burst was detected and to which the accompanying Correction Message Descriptor applies. This number follows the numbering scheme defined in clause 7.5.1.3.

6.4.17.11 Void

6.4.17.12 Implementation Type Descriptor (optional)

This descriptor specified in table 6-63 supports indication of the generic implementation type of the NCC/gateway. The indicated options can be interpreted by the RCST without additional information. The information provided can assist the RCST in choosing a way to operate that will work. The descriptor supports system specific extensions.

Table 6-63: Syntax of the Implementation Type Descriptor

Syntax	No. of bits		Information Mnemonic
	Reserved	Information	
Implementation_type_descriptor() {			
descriptor_tag		8	uimsbf
descriptor_length		8	uimsbf
ncc_protocol_version		8	uimsbf
location_update_allowed_flag	2	1	bslbf
rbdc_accepted_flag		1	bslbf
vbdc_accepted_flag		1	bslbf
avbdc_accepted_flag		1	bslbf
timing_offset_flag		1	bslbf
timing_reference_flag		1	bslbf
C2P_protocol_version	5	3	uimsbf
ncc_type_id		24	uimsbf
ncc_sw_id		24	uimsbf
user_options_count		8	uimsbf
For(i=0; i < user_options_count; i++){			
user_options_byte		8	uimsbf
}			
For(i=0; i < n; i++){			
reserved_byte		8	uimsbf
}			
}			

Semantics for the Implementation_type_descriptor:

- `descriptor_tag`: The descriptor tag is an 8 bit field which identifies the descriptor type. The value is given in table 6-2;
- `descriptor_length`: The descriptor length is an 8 bit field specifying the number of bytes of the descriptor immediately following the `descriptor_length` field. This descriptor is specifically foreseen to be extended at the end with more specific bytes in future revisions, to provide space for more information about the generic implementation type. If the `descriptor_length` specifies fewer bytes than is needed to hold the information specified in table 6-63, the descriptor is truncated at the corresponding point. This way, the information can be safely interpreted from the first byte following the header with the interpretation known by the specific RCST, skipping any unknown content. A specific system may use a short or long descriptor to convey as much information as desired. However, if a non-zero value of `user_options_count` is specified, the `descriptor_length` shall be sufficient to accommodate the specified number of `user_options_bytes`;
- `ncc_protocol_version`: This 8 bit field indicates the RCS protocol version implemented by the NCC, coded as specified in table 6-64;

Table 6-64: RCS Protocol Version Implemented by the NCC

Value	RCS Protocol version
3 to 255	Reserved
2	Version 2.0 (this version)
1	Version 1.5

0	Version 1.4 or earlier version
---	--------------------------------

- **location_update_allowed_flag:** A '1' indicates that the NCC generally allows location updates issued by the RCST in the CSC timeslot as specified in section "CSC burst format". A '0' indicates that location update by use of the CSC timeslot is generally prohibited, but may be specifically allowed for the RCST in question according to system specific methods;
- **rbdc_accepted_flag:** A '1' indicates that the NCC honours RBDC requests on the default channel. A '0' indicates that the NCC/gateway may unconditionally discard RBDC requests on the default channel;
- **vbdc_accepted_flag:** A '1' indicates that the NCC honours VBDC requests on the default channel. A '0' indicates that the NCC may unconditionally discard VBDC requests on the default channel. This flag is mutually inclusive with the avbdc_accepted_flag;
- **avbdc_accepted_flag:** A '1' indicates that the NCC honours AVBDC requests on the default channel. A '0' indicates that the NCC may unconditionally discard AVBDC requests on the default channel. This flag is mutually inclusive with the vbdc_accepted_flag;
- **timing_offset_flag:** A '1' indicates that the NCC requires that the RCST offsets its transmission timing from the native NCR packet source reference point as indicated in the Transmission Offset Descriptor. A '0' indicates the opposite;
- **timing_reference_flag:** A '1' indicates that the NCC applies the nominal position of the return link satellite for each return path as the native NCR packet source reference point, referring to the point of time when the NCR packet with the NCR value entered the channel interleaver and FEC encoder at the nominal link rate, or to the applicable start of the frame signal (SOF) as specified for DVB-S2(X) ACM/VCM. A '0' indicates that the NCC may apply a system specific NCR source reference point;
- **C2P_Protocol_version:** This 3-bit field indicates the version of the connection control protocol defined in ETSI TS 102 602 [i.3] that is supported by the NCC, if any. The coding of the field is defined in table 6-65;

Table 6-65: Connection Control Protocol Version Implemented by the NCC

Value	Version number
2 to 7	Reserved
1	Version 1
0	No connection control protocol supported

- **ncc_type_id:** A 24 bit parameter that is used to identify the type of NCC. The value used can be an OUI value registered by the NCC vendor in the IEEE Registration Authority as a company id. If such an OUI is not applicable for the NCC, the field shall be set to 0xFFFFFFFF to indicate an undefined NCC type;
- **ncc_sw_id:** A 24 bit parameter that identifies the SW version running on the NCC in the context of a known NCC type. It should be discarded if the NCC_type_id is unknown;
- **user_options_count:** The number of bytes used to indicate user defined options;
- **user_option_byte:** The concatenated user_option_byte field contains user defined options. These options shall be interpreted in the context of a recognized ncc_type_id, and may have to be interpreted in the context of the ncc_sw_id. This is user defined. The content shall be discarded if the ncc_type_id is unknown;
- **reserved_byte:** This content shall be discarded by the receiver.

6.4.17.13 LL FEC Identifier Descriptor (optional)

This descriptor (table 6-66) defines the characteristics of one or more link layer FEC frames. The FEC frames shall not employ time slicing.

Table 6-66: LL-FEC identifier descriptor

Syntax	No. of bits		Information Mnemonic
	Reserved	Information	
fec_identifier_descriptor() {		8	uimsbf
descriptor_tag		8	uimsbf
descriptor_length		8	uimsbf
loop_count		8	uimsbf
for (i=0; i < loop_count; i++) {			
link_direction		1	bslbf
encapsulation_type		1	bslbf
if (encapsulation_type == '0') {			
elementary_stream_id	1	13	uimsbf
} else {			
gse_fec_id		14	uimsbf
}			
ll_fec		2	uimsbf
frame_size	2	3	uimsbf
buffer_timeout		3	uimsbf
dscp		6	uimsbf
reserved for future use	32		uimsbf
}			
}			
NOTE: Reserved bits are of type bslbf, and shall precede the Information bits on the same line. They shall be ignored by the RCST. For an encrypted uni-cast TIM, the bit values shall be varied in a random manner to avoid encryption spoofing.			

Semantics for LL-FEC identifier descriptor:

- descriptor_tag: The descriptor tag is an 8 bit field which identifies the descriptor type. The value is given in table 6-2;
- descriptor_length: This 8-bit field specifies the number of bytes of the descriptor immediately following this field;
- loop_count: This is an 8 bit field indicating the number of iterations in the loop that follows;
- link_direction: This 1-bit field indicates whether the referenced stream is transmitted in the forward link (set to '0') or in the return link (set to '1');
- encapsulation_type: This 1-bit field indicates whether the referenced stream is an elementary stream (set to '0') or a GSE-FEC stream (set to '1'). The value '0' is intended only for supporting migration from earlier versions of the standard. General use is not recommended;
- elementary_stream_id: This field identifies the 13-bit PID of the elementary stream carrying the LL-FEC frames. This field is available only for supporting migration from earlier versions of the standard. General use is not recommended;
- gse_fec_id: This 14-bit field carries a unique value that identifies the FEC process. It is used to associate individual LL_FEC frames with the process;
- ll_fec: This 2-bit field indicates whether the referenced elementary stream uses LL-FEC, and which algorithm is used. Coding of this field is according to table 6-67;

Table 6-67: LL-FEC algorithm definition

Value	LL-FEC	Algorithm
00	LL-FEC not used	n/a
01	LL-FEC used	Reed-Solomon code
10	LL-FEC used	Raptor code
11	reserved for future use	reserved for future use

- **frame_size:** This 3-bit field indicates the exact number of rows in each LL-FEC Frame. The coding of the field is according to table 6-68;

Table 6-68: LL_FEC frame size coding

Value	LL-FEC Frame rows (RS)	LL-FEC Frame rows (Raptor)	Address Granularity (Raptor)	Max LL-FEC ADT Size (Raptor, Informative)
0x00	256	256	2	16 777 216 bits = 16 Mbits
0x01	512	512	4	33 554 432 bits = 32 Mbits
0x02	768	768	6	50 331 648 bits = 48 Mbits
0x03	1 024	1 024	8	67 108 864 bits = 64 Mbits
0x04	reserved for future use	64	1	4 194 304 bits = 4 Mbits
0x05	reserved for future use	2 048	16	134 217 728 bits = 128 Mbits
0x06	reserved for future use	4 080	32	267 386 880 bits = 255 Mbits
0x07	reserved for future use	reserved for future use	reserved for future use	reserved for future use

NOTE: The address granularity is 1 for all Reed-Solomon code options.

- **buffer_timeout:** This 3-bit field indicates the time in milliseconds for the maximum interval between the transmission of the first section with a given fec_frame_number (in general a data section) and the transmission of last section with the same fec_frame_number (in general a parity section). The field is coded in accordance with table 6-69;

Table 6-69: Coding of LL_FEC buffer timeout

Value	buffer timeout (ms)
0x00	10
0x01	40
0x02	160
0x03	640
0x04	2 560
0x05	10 240
0x06	not specified
0x07	reserved for future use

- **dscp:** This 6-bit field can be used to signal a Differentiated Services Code Point (DSCP) associated with LL-FEC Frame or any other type of Quality-of-Service label. The value is system-dependent;
- **reserved_for_future_use:** This 32-bit field shall be set to "0xFFFFFFFF".

6.4.17.14 Frame Payload Format Descriptor

This descriptor provides parameters used for configuring and confirming the format of the transmission payload format for the RCST.

Table 6-70: Syntax of the Frame payload format descriptor

Syntax	No. of bits		Information Mnemonic
	Reserved	Information	
frame_payload_format_descriptor() {			
descriptor_tag		8	uimsbf
descriptor_length		8	uimsbf
context_loop_count		8	uimsbf
for (i = 0; i <= ID_loop_count; i++) {			
transmission_context_id		8	uimsbf
allow_ptype_omission	3	1	bslbf
use_compressed_ptype		1	bslbf
allow_alpdu_crc		1	bslbf

Syntax	No. of bits		Information Mnemonic
	Reserved	Information	
allow_alpdu_sequence_number		1	bslbf
use_explicit_payload_header_map		1	bslbf
implicit_protocol_type		8	uimsbf
implicit_ppdu_label_size		4	uimsbf
implicit_payload_label_size		4	uimsbf
type_0_alpdu_label_size	4	4	uimsbf
}			
}			

Semantics for the frame_payload_format_descriptor:

- descriptor_tag: The descriptor tag is an 8 bit field which identifies the descriptor type. The value is given in table 6-2;
- descriptor_length: The descriptor length is an 8 bit field specifying the number of bytes of the descriptor immediately following the descriptor_length field;
- context_loop_count: An 8 bit field. The number of contexts being configured;
- transmission_context_id: This 8 bit field identifies the user traffic frame transmission context for which the configuration applies, referring to the context identification in table 6-71. The transmission context is in a transparent star network unambiguously determined by the SCT/FCT2/BCT in combination with the TBTP2;

Table 6-71: Transmission Context Identification

Context ID	Transmission Context
0	Transparent star TDMA, access dedicated to one RCST
1	Transparent star TDMA, slotted aloha
2	Transparent star TDMA, CRDSA
3 to 7	Reserved
8	Transparent star continuous transmission
9 to 15	Reserved
16	Transparent mesh overlay TDMA, general purpose
17 to 31	Reserved
32	Regenerative mesh TDMA, general purpose
33 to 127	Reserved
128 to 255	User defined

- allow_ptype_omission: This flag indicates whether omission of the explicit protocol type indication from the ALPDU is allowed. If set, the protocol type indication may be suppressed;
- use_compressed_ptype: This 1 bit field gives instruction about to use compressed protocol type or not when explicitly indicating the protocol type. '1' instructs to use the compressed type instead of the standard protocol type of 2 byte;
- allow_alpdu_crc: This flag indicates whether the transmitter is allowed to append CRC32 to the SDU in an ALPDU. '1' indicates that this is allowed;
- allow_alpdu_sequence_number: This flag indicates whether the transmitter is allowed to append a fragmentation sequence number to the SDU in an ALPDU. '1' indicates that this is allowed;
- use_explicit_payload_header_map: This flag indicates whether the optional first byte of the payload header is present. '1' indicates that it is present. When it is omitted, the configured implicit values apply. When present, the explicit values indicated in the map indicated take precedence;
- implicit_protocol_type: This 8 bit field indicates the protocol type that applies when the explicit protocol type indication is omitted and a configurable implicit protocol type apply. The indicated protocol type refers to one of the compressed protocol types supported in the system;
- implicit_ppdu_label_size: This 4 bit field indicates the length of the PPDU Label when this is not explicitly indicated for the format in the transmitted payload;

- `implicit_payload_label_size`: This 4 bit field indicates the length of the Payload Label when this is not explicitly indicated for the format in the transmitted payload;
- `type_0_alpdu_label_size`: This 4 bit field indicates the size of the ALPDU label associated with the indication of the configurable-size ALPDU label type '0'.

6.4.17.15 Pointing Alignment Support Descriptor

Table 6-72 shows the syntax and format of the pointing alignment support descriptor.

Table 6-72: Syntax of the Pointing Alignment Control Descriptor

Syntax	No. of bits		Mnemonic
	Reserved	Information	
<code>pointing_alignment_control_descriptor() {</code>			
<code>descriptor_tag</code>		8	<code>uimsbf</code>
<code>descriptor_length</code>		8	<code>uimsbf</code>
<code>alignment_control_type</code>		8	<code>uimsbf</code>
<code>if (alignment_control_type == 0) {</code>			
<code>user_defined_alignment</code>		4	<code>blsbf</code>
<code>burst_based_alignment_supported</code>	1	1	<code>blsbf</code>
<code>cw_based_alignment_supported</code>		1	<code>blsbf</code>
<code>pointing_alignment_required</code>		1	<code>blsbf</code>
<code>forward_link_snr_threshold</code>		8	<code>uimsbf</code>
<code>}</code>			
<code>if (alignment_control_type == 1) {</code>			
<code>for (i=0; i<(descriptor_length - 1); i++) {</code>			
<code>operator_ref_byte</code>		8	<code>blsbf</code>
<code>}</code>			
<code>}</code>			
<code>if (alignment_control_type == 64) {</code>			
<code>alignment_population_id</code>		16	<code>uimsbf</code>
<code>co_pol_threshold</code>		16	<code>uimsbf</code>
<code>x_pol_threshold</code>		16	<code>uimsbf</code>
<code>remaining_duration</code>		8	<code>uimsbf</code>
<code>}</code>			
<code>if (alignment_control_type == 65) {</code>			
<code>co_pol_threshold</code>		16	<code>uimsbf</code>
<code>x_pol_threshold</code>		16	<code>uimsbf</code>
<code>remaining_duration</code>		8	<code>uimsbf</code>
<code>}</code>			
<code>if (alignment_control_type == 66) {</code>			
<code>alignment_probe_pattern</code>		16	<code>uimsbf</code>
<code>}</code>			
<code>if (alignment_control_type == 67) {</code>			
<code>cw_eirp</code>		8	<code>uimsbf</code>
<code>cw_frequency</code>		32	<code>uimsbf</code>
<code>cw_start_time</code>		32	<code>uimsbf</code>
<code>cw_duration</code>		32	<code>uimsbf</code>
<code>}</code>			
<code>if (alignment_control_type == 68) {</code>			
<code>cw_frequency</code>		32	<code>uimsbf</code>
<code>cw_start_time</code>		32	<code>uimsbf</code>
<code>cw_duration</code>		32	<code>uimsbf</code>
<code>}</code>			
<code>if (alignment_control_type == 96) {</code>			
<code>alignment_status</code>		8	<code>blsbf</code>
<code>cnr</code>		8	<code>uimsbf</code>
<code>co_pol_reading</code>		16	<code>uimsbf</code>
<code>x_pol_reading</code>		16	<code>uimsbf</code>
<code>}</code>			
<code>}</code>			

Semantics of the `pointing_alignment_control_descriptor`:

- **descriptor_tag:** The descriptor tag is an 8 bit field which identifies the descriptor type. The value is given in table 6-2;
- **descriptor_length:** The descriptor length is an 8 bit field specifying the number of bytes of the descriptor immediately following the descriptor_length field;
- **alignment_control_type:** The one byte alignment control type indicates what type of control type the descriptor contains. The different alignment control types are indicated in table 6-73;

Table 6-73: Alignment control types

Bit	Usage	Occurrence
0	Broadcast declaration	TIM-B
1	Broadcast NOC reference	TIM-B
2 to 63	Reserved	
64	Alignment procedure with use of a specific POPID	TIM-U
65	Alignment procedure w/o changing POPID	TIM-U
66	Burst based alignment	TIM-U
67	CW based alignment, dynamic EIRP	TIM-U
68	CW based alignment, fixed EIRP	TIM-U
69 to 95	Reserved	
96	Alignment feedback	TIM-U
97 to 127	Reserved	
128 to 255	User Defined	

- **user_defined_alignment:** This 4 bit field may be used to convey user defined alignment system information;
- **burst_based_alignment_supported:** This flag indicates whether the NCC supports automated burst based alignment. A '1' indicates support;
- **cw_based_alignment_supported:** This flag indicates whether the NCC supports automated CW based alignment. A '1' indicates support;
- **pointing_alignment_required:** This flag indicates whether the NCC requires the RCST to perform an alignment procedure to get its status raised to "confirmed aligned" before being allowed access to the network. A '1' indicates that this is an absolute requirement. A '0' indicates that the NCC may accept access according to other system dependent policies;
- **forward_link_snr_threshold:** This 8 bit field indicates the minimum SNR required before allowed to activate the return link transmitter, given in units of 1/10 of dB;
- **operator_ref_byte:** This 8 bit field holds one byte from the consecutive sequence of (descriptor_length-1) bytes constituting an ASCII string that nominally provides a reference to a network operations centre that can support with the alignment;
- **alignment_population_id:** This 16 bit field holds the population ID that the RCST temporarily takes on when seeking the forward link and return link where to perform the pointing alignment procedure;
- **co_pol_threshold:** This 16 bit field indicates the minimum accepted co-polarization power reading, given in 0,1 dB resolution;
- **x_pol_threshold:** This 16 bit field indicates the maximum accepted x-pol power reading, given in 0,1 dB resolution;
- **remaining_duration:** This 8 bit field indicates the maximum allowed remaining duration for the alignment procedure from the time of reception of this indication, given in seconds;
- **alignment_probe_pattern:** This 16 bit field indicates the bit pattern for the alignment probe logon burst;
- **cw_eirp:** This 8 bit field indicates the RCST EIRP level to be used for CW by an RCST that has configurable CW EIRP implemented. The level is given in dBm;
- **cw_frequency:** This 32 bit field indicates the centre frequency for the CW transmission, in 100 Hz units;

- `cw_start_time`: This 32 bit field indicates the start time for the CW transmission with reference to the start NCR value relative to the NCR;
- `cw_duration`: This 32 bit field indicates the duration for the CW transmission relative to the time of start, given in NCR ticks;
- `alignment_status`: This 8 bit field indicates the current alignment status as indicated in table 6-74;

Table 6-74: Current alignment status

Value	Usage
3 to 255	Reserved
2	Alignment failure
1	Alignment success
0	In progress

- `cnr`: Carrier to noise ratio as determined by the receiver at the NCC side, given in 0,1 dB resolution;
- `co_pol_reading`: This 16 bit field indicates the most recent co-pol power estimate, given in 0,1 dB resolution;
- `x_pol_reading`: This 16 bit field indicates the most recent x-pol power estimate, given in 0,1 dB resolution.

6.4.17.16 Forward Link Streams Descriptor (optional)

Table 6-75 specifies the syntax of the Forward Link Streams Descriptor.

Table 6-75: Syntax of the Forward Link Streams Descriptor

Syntax	No. of bits		Information Mnemonic
	Reserved	Information	
<code>forward_link_streams_descriptor() {</code>			
<code>descriptor_tag</code>		8	<code>uimsbf</code>
<code>descriptor_length</code>		8	<code>uimsbf</code>
<code>for (i=0; i<n; i++)</code>			
<code>ISI_loop_count</code>	4	4	<code>uimsbf</code>
<code>for (k=0; k < ISI_loop_count; k++) {</code>			
<code>supplemental_ISI</code>		8	<code>uimsbf</code>
<code>}</code>			
<code>}</code>			
<code>}</code>			

Semantics for the `forward_link_streams_descriptor`:

- `descriptor_tag`: The descriptor tag is an 8 bit field which identifies the descriptor type. The value is given in table 6-2;
- `descriptor_length`: The descriptor length is an 8 bit field specifying the number of bytes of the descriptor immediately following the `descriptor_length` field;
- `ISI_loop_count`: A 4 bit field that indicates the number of iterations in the loop following;
- `supplemental_ISI`: An 8 bit field that indicates an ISI that is use to carry traffic to the RCST.

6.4.17.17 Lower Layer Service Descriptor

The use of the link service descriptor is not additive. Reception of a new descriptor replaces the configuration provided by the previous.

Table 6-76: Lower Layer Service descriptor format and syntax

Syntax	No. of bits		Mnemonic
	Reserved	Information	
lower_layer_service_descriptor() {			
descriptor_tag		8	uismbf
descriptor_length		8	uimsbf
default_control_randomization_interval		8	uimsbf
dynamic_rate_persistence		8	uismbf
volume_backlog_persistence		8	uismbf
lower_layer_service_count	4	4	uismbf
for (a = 0; a < lower_layer_service_count; a++) {			
lower_layer_service_index	2	4	
random_access		1	
dedicated_access		1	
if (dedicated_access == 1) {			
nominal_rc_index		4	uismbf
nominal_da_ac_index		4	uismbf
conditional_demand_rc_map		16	bslbf
conditional_scheduler_da_ac_map		16	uismbf
}			
if (random_access == 1) {			
nominal_ra_ac_index	4	4	uimsbf
conditional_scheduler_ra_ac_map		8	uismbf
}			
rc_count	4	4	uismbf
for (c = 0; c < rc_count; c++) {			
rc_index		4	
constant_assignment_provided	1	1	bslbf
volume_allowed		1	bslbf
rbdc_allowed		1	bslbf
maximum_service_rate		16	uismbf
minimum_service_rate		16	uismbf
if (constant_assignment_provided == 1) {			
constant_service_rate		16	uismbf
}			
if (volume_allowed == 1) {			
maximum_backlog		8	uismbf
}			
}			
ra_ac_count	4	4	uismbf
for (b = 0; b < ra_ac_count; b++) {			
ra_ac_index	4	4	uimsbf
max_unique_payload_per_block		8	uimsbf
max_consecutive_block_accessed		8	uimsbf
min_idle_block		8	uimsbf
defaults_field_size (n)		8	uimsbf
defaults_for_ra_load_control		n x 8	uimsbf
}			
}			

Semantics for the lower_layer_service_descriptor:

- descriptor_tag: The descriptor tag is an 8 bit field which identifies the descriptor type. The value is given in table 6-2;
- descriptor_length: The descriptor length is an 8 bit field specifying the number of bytes of the descriptor immediately following the descriptor_length field;
- default_control_randomization_interval: This 8 bit parameter indicates the default value for the randomization interval to be used when selecting a slotted aloha timeslot for the contention control burst, given in milliseconds;

- **dynamic_rate_persistence:** An 8 bit field that indicates the nominal persistence of the rate assignment in response to an RBDC request, given as a multiple of the superframe duration;
- **volume_backlog_persistence:** An 8 bit field that indicates the nominal persistence of the volume request backlog after receiving a volume request, given as a multiple of the superframe duration;
- **lower_layer_service_count:** A 4 bit field indicating the number of lower layer services addressed by the lower layer service descriptor;
- **lower_layer_service_index:** A 4 bit field identifying a lower layer service;
- **random_access:** A 1 bit field indicating if random access is supported for the associated Link Stream. A value of '1' indicates that it is supported. A value of '0' indicates that it is not supported;
- **dedicated_access:** A 1 bit field indicating if dedicated access is supported for the associated Link Stream. A value of '1' indicates that it is supported. A value of '0' indicates that it is not supported;
- **nominal_rc_index:** A 4 bit field indicating the nominal request class for the associated Link Service;
- **nominal_da_ac_index:** A 4 bit field indicating the nominal dedicated access allocation channel associated with the Link Stream. The Assignment ID associated to the request class has an offset to the Assignment ID Base equal to the nominal_da_ac_index;
- **conditional_demand_rc_map:** A 16 bit field indicating the allowance to conditionally map resource demand for the associated Link Stream into capacity requests for other RCs, with bit 0 referring to rc_index=0, bit 1 referring to rc_index=1 and so on;
- **conditional_scheduler_da_ac_map:** A 16 bit field indicating the allowance to conditionally map traffic from the Link Stream into the different dedicated assignment allocation channels, indicated by a flag for each DA-AC, with bit 0 referring to da_ac_index=0, bit 1 referring to da_ac_index=1 and so on;
- **nominal_ra_ac_index:** A 4 bit field indicating the nominal random access allocation channel associated with the Link Lower layer Service. The corresponding Assignment ID equals the highest Assignment ID value in the system minus ra_ac_index;
- **conditional_scheduler_ra_ac_map:** An 8 bit field indicating the allowance to conditionally map Link Stream traffic into the different random access allocation channels, indicated by a flag for each RA-AC, with bit 0 referring to ra_ac_index=0, bit 1 referring to ra_ac_index=1 and so on;
- **rc_count:** A 4 bit field indicating the number of request classes specified by the Lower Layer Service descriptor;
- **rc_index:** A 4 bit field identifying one request class;
- **constant_assignment_provided:** A 1 bit field indicating if constant non-solicited assignment is provided for the request class;
- **volume_allowed:** A 1 bit field indicating if A/VBDC requests is allowed issued for the rc_index. A value of '1' indicates that it is allowed. A value of '0' indicates that it is not allowed;
- **rbdc_allowed:** A 1 bit field indicating if RBDC request is allowed issued for the rc_index. A value of '1' indicates that it is allowed. A value of '0' indicates that it is not allowed;
- **constant_service_rate:** A 16 bit field indicating the admitted CRA level associated with the request class, in kbps;
- **maximum_service_rate:** A 16 bit field indicating the maximum service rate for the rc_index, in kbps; The maximum allowed RBDC level equals this level subtracted by the CRA;
- **minimum_service_rate:** A 16 bit field indicating the minimum rate that can be expected assigned when actively requesting any dynamic capacity for the rc_index, in kbps;
- **maximum_backlog:** An 8 bit field indicating the maximum volume request backlog that the NCC will accept to hold for the rc_index, in KB;

- `ra_ac_count`: A 4 bit field indicating the number of random access allocation channels specified by the Lower Layer Service descriptor;
- `ra_ac_index`: A 4 bit field identifying one random access allocation channel and implicitly the load control method as bound to the RA channel by the Random Access Method descriptor;
- `max_unique_payload_per_block`: This is an 8-bit field that indicates the maximum number of unique payloads that the RCST is permitted to send in an RA block;
- `max_consecutive_blocks_accessed`: This is an 8-bit field that indicates the maximum number of consecutive RA blocks that the RCST is permitted to access for sending of unique payloads. A '0xFF' value indicates no upperbound;
- `min_idle_blocks`: This is an 8-bit field that indicates the minimum number of RA blocks that the RCST shall ignore for a given `ra_ac_index` after having accessed a maximum allowed number of consecutive RA blocks;
- `defaults_field_size`: An 8 bit field indicating the method dependent size of the `defaults_for_ra_load_control` field that contains the default values for the dynamic load control parameters;
- `defaults_for_load_control`: A `defaults_field_size` byte field that contains the default values for the load control method for the random access allocation channel. The parameter set and the internal structure of this field is equal to the parameter set specified for the RA load control method in the Random Access Load Control descriptor in clause 6.4.17.24.

6.4.17.18 Logon Response Descriptor

Table 6-77 specifies the format and syntax of the Logon Response Descriptor.

Table 6-77: Syntax of the Logon Response Descriptor

Syntax	No. of bits		Mnemonic
	Reserved	Information	
<code>logon_response_descriptor() {</code>			
<code>descriptor_tag</code>		8	<code>uimsbf</code>
<code>descriptor_length</code>		8	<code>uimsbf</code>
<code>keep_identifiers_after_logoff</code>	1	1	<code>bsblf</code>
<code>power_control_mode</code>		2	<code>bsblf</code>
<code>RCST_access_status</code>		4	<code>bsblf</code>
<code>group_id</code>		8	<code>uimsbf</code>
<code>logon_id</code>		16	<code>uimsbf</code>
<code>lowest_assignment_id</code>		24	<code>uimsbf</code>
<code>assignment_id_count</code>		4	<code>uimsbf</code>
<code>unicast_mac24_count</code>		4	<code>uimsbf</code>
<code>for (b = 0; b < unicast_mac24_count; b++) {</code>			
<code>mac24_prefix_size</code>	3	5	<code>uimsbf</code>
<code>unicast_mac24</code>		24	<code>uimsbf</code>
<code>mcast_mapping_method</code>	1	1	<code>bsblf</code>
<code>mcast_ip_version_ind_presence</code>		1	<code>bsblf</code>
<code>mcast_synthesis_field_size</code>		5	<code>uimsbf</code>
<code>}</code>			
<code>default_svn_number</code>		16	<code>uimsbf</code>
<code>reserved</code>		8	<code>uimsbf</code>
<code>}</code>			

Semantics for the `logon_response_descriptor`:

- `descriptor_tag`: The descriptor tag is an 8 bit field which identifies the descriptor type. The value is given in table 6-2;
- `descriptor_length`: The descriptor length is an 8 bit field specifying the number of bytes of the descriptor immediately following the `descriptor_length` field;

- `keep_identifiers_after_logoff`: One bit indicating if the RCST is allowed to keep the assigned identifiers after logoff or not. '0' indicates that the RCST shall discard the assigned identifiers. '1' indicates that the RCST may keep the identifiers;
- `power_control_mode`: Two bits indicating the EIRP control mode to be applied by the RCST, coded as shown in table 6-78. The modes are specified in clause 9.9.1;

Table 6-78: EIRP Control Modes

Code	Value
0	Constant EIRP adjusted by NCC
1	Autonomous EIRP control based on E_s/N_0 reported by NCC
2	Constant power spectrum density adjusted by NCC
3	Reserved

- `RCST_access_status`: A 4 bit field indicating the current access status of the RCST as determined by the NCC, using a syntax corresponding bit-by-bit to the RCST status field in the logon request as specified in clause 8.3.1;
- `group_id`: An 8 bit field indicating the Group ID assigned to the RCST;
- `logon_id`: A 16 bit field indicating the Logon ID assigned to the RCST;
- `lowest_assignment_id`: A 24 bit field indicating the lowest value Assignment ID allocated to the RCST;
- `assignment_id_count`: An 4 bit field indicating the total number of consecutive higher value Assignment IDs that are assigned to the RCST including the lowest value Assignment ID;
- `unicast_mac24_count`: A 4 bit field indicating the number of unicast MAC24 addresses that are assigned to the RCST in the following loop;
- `mac24_prefix_size`: A 5 bit field that indicates the number of most significant bits of the associated unicast MAC24 that holds the most significant bits of the SVN number;
- `unicast_mac24`: A 24 bit field that assigns one unicast MAC24 to the RCST;
- `mcast_mapping_method`: A 1 bit field that indicates the higher layer multicast address mapping method that is used for the SVN. The value '1' indicates that the SVN resorts to MMT2 for this mapping. The value '0' indicates that the SVN resorts to autonomous synthesis of the multicast MAC24 address as specified in clause 5.2.3.1;
- `mcast_ip_version_ind_presence`: A 1 bit field that indicates whether a bit in the mcast MAC24 address is allocated to indicate IP version. The value '1' indicates that one bit is used to indicate IP version. The field is reserved when the MMT2 is used for the mapping;
- `mcast_synthesis_field_size`: A 5 bit field that indicates the number of least significant mcast MAC24 bits that shall be synthesized from the network layer multicast address. The field is reserved when the MMT2 is used for the mapping;
- `default_svn_number`: A 16 bit field indicating the SVN number that the receiver side assumes when receiving PDUs without explicit indication of the source interface;
- `reserved`: An 8 bit field that shall hold zero value.

6.4.17.19 DHCP Option Descriptor

Table 6-79 shows the syntax and content of the DHCP option descriptor. This descriptor is capable of transporting via the forward link in TIM-U and TIM-B standardized DHCP options specified by IETF as well as custom DHCP options. Several DHCP Option Descriptors may occur in the same TIM in order to indicate different options.

Table 6-79: DHCP Option Descriptor Format and Syntax

Syntax	No. of bits		Mnemonic
	Reserved	Information	
dhcp_option_transport_descriptor() {			
descriptor_tag		8	uismbf
descriptor_length		8	uimsbf
layer_2_interface		24	uismbf
option_code		8	uismbf
for (b = 0; b < descriptor_length-4; b++) {			
option_byte		8	bslbf
}			
}			

- descriptor_tag: The descriptor tag is an 8 bit field which identifies the descriptor type. The value is given in table 6-2;
- descriptor_length: The descriptor length is an 8 bit field specifying the number of bytes of the descriptor immediately following the descriptor_length field;
- layer_2_interface: A 24 bit field that in TIM-U holds the MAC24 associated with the layer 2 interface. This field is set to '0xFFFFF' when used in TIM-B;
- option_code: An 8 bit field holding one of the applicable DHCP option codes as listed in table 6-80;
- option_byte: A sequence of option_byte constitutes the content of the DHCP option following after the length field of the DHCP option with the corresponding code. The length of the DHCP option shall be deduced from the descriptor length. The DHCP option is either a standard one from the portfolio specified by IETF or a user specified option in the range allowed by the IETF. Table 6-80 lists options recognized by the present document.

Table 6-80: DHCP Options as used in TIM-B and TIM-U

Option code	Used in TIM-B	Used in TIM-U
6	IPv4 DNS addresses	IPv4 DNS addresses
12	-	Host name (username)
26	Layer 2 interface MTU	Layer 2 interface MTU
43	Vendor specific	Vendor specific
55	List of options available as response to a request in logon	-
128 to 150	Reserved for ETSI TS 101 545-3 [i.16]	Reserved for ETSI TS 101 545-3 [i.16]

6.4.17.20 TRANSEC Message Descriptor

Table 6-81 shows the syntax and content of the TRANSEC Message Descriptor. This descriptor is capable of transporting via the forward link in TIM-U and TIM-B messages for the applicable TRANSEC system.

Table 6-81: TRANSEC Message Descriptor Format and Syntax

Syntax	No. of bits		Mnemonic
	Reserved	Information	
transec_message_descriptor() {			
descriptor_tag		8	uismbf
descriptor_length		8	uimsbf
transec_message_type		8	uismbf
for (b = 0; b < descriptor_length-1; b++) {			
transec_message_byte		8	bslbf
}			
}			

Semantics for the transec_message_descriptor:

- `descriptor_tag`: The descriptor tag is an 8 bit field which identifies the descriptor type. The value is given in table 6-2;
- `descriptor_length`: The descriptor length is an 8 bit field specifying the number of bytes of the descriptor immediately following the `descriptor_length` field;
- `transec_message_type`: An 8 bit field that indicates a specific message type for the TRANSEC system;
- `transec_message_byte`: An 8 bit field that holds one byte of the contiguous sequence of bytes in the specific TRANSEC message.

6.4.17.21 Transmission Offset Descriptors

6.4.17.21.0 Introduction

There are 2 possibilities to describe the Transmission Offset. The first is by using the `transmission_offset_descriptor` 6.4.17.21.1 or the `transmission_offset_v2_descriptor` 6.4.17.21.2.

When the SAT table (6.4.7.2) is used to obtain satellite position information then the `transmission_offset_v2_descriptor` shall be used.

When the `transmission_offset_v2_descriptor` is used then SAT table (6.4.7.2) shall be signalled to provide satellite position information.

Transponders which require the `transmission_offset_v2_descriptor` (e.g. non-geostationary satellites) will exclude older receivers. Existing receivers where support of these transponders is wanted, will have to add support for the `transmission_offset_v2_descriptor`, otherwise the transponders will be ignored.

For transponders compatible with the `transmission_offset_v2_descriptor`, using that descriptor will allow to include the receivers that do not support `transmission_offset_v2_descriptor`.

In order to support receivers that don't support the `transmission_offset_v2_descriptor`, the `transmission_offset_descriptor` shall be used.

6.4.17.21.1 Transmission Offset Descriptor

The Transmission Offset Descriptor specified in table 6-82 provides the delays between NCCs and satellites as well as between Traffic Gateways and satellites. This information is intended to be used to offset the timing advance when transmitting the initial logon burst.

Table 6-82: Syntax of the Transmission Offset Descriptor

Syntax	No of bits		Information mnemonic
	Reserved	Information	
<code>transmission_offset_descriptor () {</code>			
<code>descriptor_tag</code>		8	uimbsf
<code>descriptor_length</code>		8	uimbsf
<code>forward_link_combinations</code>		8	uimbsf
<code>for (i=0; i<forward_link_combinations; i++) {</code>			
<code>satellite_id</code>		8	uimbsf
<code>NCC_id</code>		8	uimbsf
<code>propagation_delay</code>		32	ncvmsbf
<code>}</code>			
<code>return_link_combinations</code>		8	uimbsf
<code>for (i=0; i<return_link_combinations; i++) {</code>			
<code>satellite_id</code>		8	uimbsf
<code>gateway_id</code>		8	uimbsf
<code>propagation_delay</code>		32	ncvmsbf
<code>}</code>			
<code>}</code>			

Semantics for the `transmission_offset_descriptor`:

- **descriptor_tag:** The descriptor tag is an 8 bit field which identifies the descriptor type. The value is given in table 6-2;
- **descriptor_length:** The descriptor length is an 8 bit field specifying the number of bytes of the descriptor immediately following the descriptor_length field;
- **forward_link_combinations:** This 8 bit field defines the number of all applicable NCC to satellite combinations on the forward link;
- **satellite_id:** This 8 bit field defines the identifier of the satellite end of one combination. The satellite_id is assigned by the system administrator. The RCST shall match this satellite_id with the satellite_id provided in the Satellite Forward Link Descriptor;
- **NCC_id:** This 8 bit field defines the identifier of the NCC end of one combination. The NCC_id is assigned by the system administrator. The RCST shall match this NCC_id with the NCC_id provided in the Satellite Forward Link Descriptor;
- **propagation_delay:** This 32 bit field defines the propagation_delay between NCC and satellite as an NCR count. For the forward link it is the delay from NCC to satellite while for the return link it is the delay from satellite to Gateway. The 32 bits corresponds to a maximum delay of 93,2 s. RCSTs may use this information to compute delays. When the optional PCR TS packet payload section is present, and the forward link combination matches the satellite_id and NCC_id in use, the RCST shall add the value of the delay included to the result of the delay calculation based on the RCST position and the Satellite Position Table; i.e. the transmission instant shall be advanced by an amount equal to the value of the forward link propagation_delay, compared to that determined without considering the propagation_delay value. The value of the delay is dependent on the implementation of the NCC. When the return link combination matches the satellite_id and gateway_id in use, the RCST shall add the value of the delay included to the delay calculation based on the RCST position and the Satellite Position Table. When applicable values for both forward and return link are present, the correction shall be the sum of the two values;

NOTE: If the values provided correspond to the actual delays between NCC and satellite and between satellite and gateway respectively, the corresponding correction will place the system timing reference plane at the gateway. If zero values are transmitted, or offset values are not provided, the reference plane will be located at the satellite. The location of the reference plane is system dependent.

- **return_link_combinations:** This 8 bit field defines the number of all applicable satellite to Gateway combinations on the return link;
- **gateway_id:** This 8 bit field defines the identifier of the Gateway end of one combination. The Gateway_id is assigned by the system administrator. The RCST shall select the data for the gateway_id that corresponds to the gateway_id provided in the Satellite Return Link Descriptor.

6.4.17.21.2 Transmission Offset V2 Descriptor

If satellite information is provided by the SAT table (6.4.7.2), the transmission Offset v2_Descriptor specified in table 6-82a shall be used.

Table 6-83a: Syntax of the Transmission Offset Descriptor

Syntax	No of bits		Information mnemonic
	Reserved	Information	
transmission_offset_v2_descriptor () {			
descriptor_tag		8	uimsbf
descriptor_length		8	uimsbf
forward_link_combinations		8	uimsbf
for (i=0; i<forward_link_combinations; i++) {			
satellite_id		24	uimsbf
NCC_id		8	uimsbf
propagation_delay		32	ncvmsbf
}			
return_link_combinations		8	uimsbf
for (i=0; i<return_link_combinations; i++) {			
satellite_id		24	uimsbf

Syntax	No of bits		Information mnemonic
	Reserved	Information	
gateway_id		8	uimsbf
propagation_delay		32	ncvmsbf
}			
}			

Semantics for the transmission_offset_descriptor:

- descriptor_tag: As defined in 6.4.17.21.1;
- descriptor_length: As defined in 6.4.17.21.1;
- forward_link_combinations: As defined in 6.4.17.21.1;
- satellite_id: This 24 bit field defines the identifier of the satellite end of one combination. The satellite_id is assigned by the system administrator. The RCST shall match this satellite_id with the satellite_id provided in the Satellite Forward Link v2 Descriptor;
- NCC_id: As defined in 6.4.17.21.1;
- propagation_delay: As defined in 6.4.17.21.1;
- return_link_combinations: As defined in 6.4.17.21.1;
- gateway_id: As defined in 6.4.17.21.1.

6.4.17.22 RCS Content Descriptor (optional)

The RCS Content descriptor identifies the elementary streams used to transport the lower layer signalling in a TS packet stream so that the RCST can locate this signalling. This descriptor type shall be placed in the second loop of the Program Map Table (PMT) defined in ISO/IEC 13818-1 [6], section 2.4.4.8/table 2-28. Each instance of the descriptor in the PMT indicates by reference to table_id values the lower layer signalling information to be found in the elementary stream using the associated PID.

The use of the RCS content descriptor for the RMT is optional.

Table 6-84: Syntax of the RCS Content Descriptor

Syntax	No. of bits		Information Mnemonic
	Reserved	Information	
RCS_content_descriptor() {			
descriptor_tag		8	uimsbf
descriptor_length		8	uimsbf
for (i=0; i<N; i++) {			
table_id		8	uimsbf
}			
}			
NOTE: N is the number of "table_id"s listed in the descriptor.			

Semantics for the RCS_content_descriptor:

- descriptor_tag: The descriptor tag is an 8 bit field which identifies the descriptor type. The value is given in table 6-2;
- descriptor_length: The descriptor length is an 8 bit field specifying the number of bytes of the descriptor immediately following the descriptor_length field;
- table_id: This 8 bit field gives a table_id value, as defined in table 6-1.

6.4.17.23 Logon Security Descriptor (optional)

The Logon Security Descriptor specified in table 6-85 allows the NCC to announce the requirements to the content of the logon burst in order to accept a user to register a subscription at an RCST and specific requirements to the content of subsequent logon requests.

Table 6-85: Logon Security Descriptor Format and Syntax

Syntax	No. of bits		Mnemonic
	Reserved	Information	
logon_security_descriptor() {			
descriptor_tag		8	uismbf
descriptor_length		8	uimsbf
userid_size		3	uismbf
always_sign		1	bslbf
minimum_signature_size		3	uismbf
}			

Semantics of the logon security descriptor:

- descriptor_tag: The descriptor tag is an 8 bit field which identifies the descriptor type. The value is given in table 6-2;
- descriptor_length: The descriptor length is an 8 bit field specifying the number of bytes of the descriptor immediately following the descriptor_length field;
- userid_size: A 3 bit field indicating the required size of the user ID in the logon request;
- always_sign: A 1 bit field indicating the requirement for signing every logon request with a signature. '1' indicates that every logon request has to be signed. '0' indicates that the signature may be omitted when not required to bind the user ID to the specific RCST HID;
- minimum_signature_size: A 3 bit field indicating the minimum size in bytes that will be accepted for the signature in the logon request.

6.4.17.24 Random Access Load Control Descriptor

The Random Access Load Control Descriptor specified in table 6-86 supports dynamic update of random access load control parameters. It does implicitly define the syntax and structure of the load control parameter field as used to provide default values in the Lower Layer Service descriptor.

Table 6-86: Syntax of the Random Access Load Control Descriptor

Syntax	No. of bits		Mnemonic
	Reserved	Information	
random_access_load_control_descriptor() {			
descriptor_tag		8	uismbf
descriptor_length		8	uimsbf
superframe_sequence		8	uimsbf
ra_ac_index_count	4	4	uimsbf
for (n=0; i < ra_ac_index_count; n++) {			
ra_ac_index	4	4	uimsbf
load_control_parameter_field_size (n)		8	uimsbf
if (load_control_method == 0) { void }			
if (load_control_method == 1) {			
back_off_time		16	uimsbf
back_off_probability		16	uimsbf
}			
if (load_control_method > 127) {			
user_defined_method		nx8	see text
}			
}			
}			

Semantics of the random_access_load_control descriptor:

- descriptor_tag: The descriptor tag is an 8 bit field which identifies the descriptor type. The value is given in table 6-2;
- descriptor_length: The descriptor length is an 8 bit field specifying the number of bytes of the descriptor immediately following the descriptor_length field;
- superframe_sequence: This is an 8-bit field that identifies a specific superframe sequence in the interactive network for which the load control parameters apply;
- ra_ac_index_count: A 4 bit field indicating the number of iterations of the following loop. A '0' indicates no iteration;
- ra_ac_index: A 4 bit field indicating the ra_ac_index that identifies a random access allocation channel as Assignment ID = (Maximum_Assignment_ID - ra_ac_index), where maximum assignment id is the maximum value that the Assignment ID field can hold;
- load_control_parameter_field_size: An 8-bit field that indicates in number of bytes the size of the load control parameter field in the current iteration of the loop. load_control_parameter_field_size is "0" for load_control_method="0";
- back_off_time: A 16-bit integer field indicating one plus the back-off time in milliseconds that a terminal shall wait before transmitting in the RA allocation channel. "0" value is reserved to indicate that the back_off_time parameter value setting in the Lower Layer Service descriptor shall be adopted by the RCST;
- back_off_probability: A 16-bit field indicating the probability for entering in back off state. When not in back off state, this is also the probability that the RCST shall avoid accessing the RA allocation channel. "0" value is reserved to indicate that the back_off_probability parameter value setting in the Lower Layer Service descriptor shall be adopted by the RCST. The integer field value is to be decremented by one and multiplied by $(1/(2^{16-2}))$ to translate into the floating point probability value;
- user_defined_method: User-defined load control parameter field that occupies an integer number of bytes. The size of load control parameter field is expressed in the load_control_parameter_size field.

6.4.17.25 CLI Instruction Descriptor (optional)

This descriptor specified in table 6-87 is included to support sending of a vendor specific CLI instruction.

Table 6-87: Syntax of the CLI Instruction Descriptor

Syntax	No. of bits		Mnemonic
	Reserved	Information	
cli_instruction_descriptor() {			
descriptor_tag		8	uismbf
descriptor_length		8	uimsbf
if (TIM-U) {			
Reserved	24		
}			
else {			
target_oui		24	uismbf
}			
if (n=0; n < descriptor_length-3 ; n++) {			
cli_instruction_byte		8	bsblf
}			
}			

Semantics of the contention_load_control descriptor:

- descriptor_tag: The descriptor tag is an 8 bit field which identifies the descriptor type. The value is given in table 6-2;

- `descriptor_length`: The descriptor length is an 8 bit field specifying the number of bytes of the descriptor immediately following the `descriptor_length` field;
- `target_oui`: This 24 bit field identifies the OUI of the RCST HID of the targeted RCSTs;
- `cli_instruction_byte`: This 8 bit field gives one byte in the contiguous sequence of bytes constituting a CLI instruction. The CLI instruction is assumed to use a vendor specific syntax.

6.4.17.26 Random Access Traffic Method Descriptor (optional)

This descriptor specified in table 6-88 is included to support configuration of the random access methods to be used, per random access allocation channel. The methods encompass one access method and one load control method.

Table 6-88: Syntax of the Random Access Traffic Method Descriptor

Syntax	No. of bits		Mnemonic
	Reserved	Information	
<code>random_access_traffic_method_descriptor() {</code>			
<code>descriptor_tag</code>		8	uismbf
<code>descriptor_length</code>		8	uimsbf
<code>superframe_sequence_count</code>		8	uimsbf
<code>for (n=0; n< superframe_sequence_count; n++) {</code>			
<code>superframe_sequence</code>		8	uimsbf
<code>ra_ac_count</code>	4	4	uimsbf
<code>for (i=0; i < ra_ac_count; i++) {</code>			
<code>ra_ac_index</code>	4	4	uimsbf
<code>load_control_method</code>		8	uimsbf
<code>number_of_instances</code>		4	uimsbf
<code>block_loop_count</code>		4	uimsbf
<code>for (n=0; n<block_loop_count; n++) {</code>			
<code>block_start_time</code>		32	ncvmsbf
<code>block_end_time</code>		32	ncvmsbf
<code>}</code>			
<code>}</code>			
<code>}</code>			
<code>}</code>			

Semantics of the `random_access_traffic_method_descriptor`:

- `descriptor_tag`: The descriptor tag is an 8 bit field which identifies the descriptor type. The value is given in table 6-2;
- `descriptor_length`: The descriptor length is an 8 bit field specifying the number of bytes of the descriptor immediately following the `descriptor_length` field;
- `superframe_sequence_count`: This 8-bit field indicates one less than the number of iterations in the loop that follows. A zero count indicates one loop;
- `superframe_sequence`: This is an 8-bit field that identifies a specific superframe sequence in the interactive network;
- `ra_ac_count`: This 4 bit field indicates one less than the number of iterations in the loop that follows. A zero count indicates one loop;
- `ra_ac_index`: This is a 4-bit field that indicates the random access allocation channel for which the rest of the loop applies;
- `load_control_method`: This 8-bit field indicates the load control method that is statically assigned to the random access allocation channel with the `ra_ac_index`. The load control methods are encoded as specified in table 6-89;

Table 6-89: Load Control Methods

Method ID	Load Control Method
0	Load control not in use
1	Load control method 1 as specified in clause 9.7.3
2 to 127	Reserved
128 to 255	User defined methods

- **number_of_instances:** This 4-bit field indicates the number of bursts to be transmitted for each unique payload. Value "1" indicates Slotted ALOHA operation. Value "0" is reserved;
- **block_loop_count:** This 4-bit field indicates the number of RA block definition loops that follow. A zero count indicates no loop (i.e. the implicit RA block definition applies);
- **block_start_time:** This 32-bit field indicates the start time of the RA block in terms of NCR count intervals with respect to the start time of the superframe. The RA block includes all RA timeslots with the given *ra_ac_index* and that starts at or later this value;
- **block_end_time:** This 32-bit field indicates the end time of the RA block in terms of NCR count intervals with respect to the start time of the superframe. The RA block excludes any timeslot that ends after this value.

6.4.17.27 Network Layer Info descriptor

The Network Layer Info descriptor provides a mechanism by which network level information can be passed to the Management Plane of the RCST during, or prior to, the start-up configuration phase of logon. As such, the message content is passed transparently through the lower layers covered by the present document and is not defined here. The descriptor is defined in table 6-90.

Table 6-90: Syntax of the Network Layer Info descriptor

Syntax	No. of bits	Mnemonic
Network_layer_info_descriptor(){		
descriptor_tag	8	uimsbf
descriptor_length	8	uimsbf
Message_body	see text	
}		

Semantics for the Network_layer_info_descriptor:

- **descriptor_tag:** The descriptor tag is an 8 bit field which identifies the descriptor type. The value is given in table 6-2;
- **descriptor_length:** The descriptor length is an 8 bit field specifying the number of bytes of the descriptor immediately following the descriptor_length field;
- **message_body:** This variable length field shall contain a datagram for passing to the target application. The length of the message body shall not exceed 255 bytes. This datagram will take the form of an SNMP message. The messages that can be passed by this method are beyond the scope of the present document.

6.4.17.28 Higher Layers Initialization descriptor

The Higher Layers Initialization descriptor supports a mechanism by which the higher layers at an RCST can be booted by the NCC at logon. The descriptor is defined in table 6-91.

Table 6-91: Syntax of the Higher Layers Initialization descriptor

Syntax	No. of bits		Mnemonic
	Reserved	Information	
higher_layers_initialization_descriptor() {			
descriptor_tag		8	uimsbf
descriptor_length		8	uimsbf
sat_l2if_count	4	4	uimsbf

for (i=0; i < sat_l2if_count; i++) {			
mac24		24	uimsbf
l2if_ipv4_m&c_address		32	uimsbf
hl_offer_stream_ipv4_mcast_identification		32	uimsbf
hl_offer_stream_port_number		16	uimsbf
higher_layer_pep_switch_off	7	1	bsblf
}			
}			

Semantics for the higher_layers_initialisation_descriptor:

- descriptor_tag: The descriptor tag is an 8 bit field which identifies the descriptor type. The value is given in table 6-2;
- descriptor_length: The descriptor length is an 8 bit field specifying the number of bytes of the descriptor immediately following the descriptor_length field;
- sat_l2if_count: A 4 bit field that indicates the number of layer 2 interfaces that are initialized;
- mac24: A 24 bit field that provides a reference to one satellite side layer 2 interface by its dedicated unicast MAC24 address;
- l2if_ipv4_m&c_address: A 32 bit field that indicates the IPv4 M&C address associated to a satellite side layer 2 interface;
- hl_offer_stream_ipv4_mcast_identification: A 32 bit field that indicates the IPv4 multicast stream to be used to discover the higher layer support offer;
- hl_offer_stream_port_number: A 16 bit field that indicates the port number used for indicating the higher layer support offer;
- higher_layer_pep_switch_off: A flag that when set to '1' indicates that the RCST shall switch off all higher layer interception PEPs for the respective satellite side layer 2 interface and apply the native protocols unmodified.

6.4.17.29 Lowest Software Version descriptor

The Lowest Software Version descriptor supports a mechanism by which the NCC may support RCSTs in avoiding to proceed with logon using a SW version that is not compatible with the NCC/gateway. The descriptor is defined in table 6-92.

Table 6-92: Syntax of the Lowest Software Version descriptor

Syntax	No. of bits		Mnemonic
	Reserved	Information	
lowest_sw_version_descriptor() {			
descriptor_tag		8	uimsbf
descriptor_length		8	uimsbf
group_count		8	uimsbf
for (i=0; i < group_count; i++) {			
oui		24	uimsbf
swdl_mcast_address		32	uimsbf
swdl_port		16	uimsbf
version_field_length		8	uimsbf
for (i=0; i < version_field_length; i++) {			
sw_version_byte		8	bsblf
}			
}			
}			

Semantics for the lowest_sw_version_descriptor:

- **descriptor_tag:** The descriptor tag is an 8 bit field which identifies the descriptor type. The value is given in table 6-2;
- **descriptor_length:** The descriptor length is an 8 bit field specifying the number of bytes of the descriptor immediately following the descriptor_length field;
- **group_count:** An 8 bit field indicates the number of RCST groups addressed by this descriptor;
- **oui:** A 24 bit field that indicates a group of RCSTs by reference to an OUI matching the OUI used in the RCST HID;
- **swdl_mcast_address:** A 32 bit field that identifies the IPv4 multicast address for a SW download multicast service;
- **swdl_port:** A 16 bit field that identifies the UDP destination port for a SW download multicast service;
- **version_field_length:** The length of the field carrying the indication of SW version for this OUI;
- **sw_version_byte:** An 8 bit field that holds one byte in the contiguous sequence of bytes constituting the field indicating the lowest SW version associated with the OUI.

6.4.17.30 Mesh System descriptor (optional)

The mesh system descriptor provides parameters used for initializing RCSTs for mesh communication. The descriptor is defined in table 6-93.

Table 6-93: Syntax of the Mesh System descriptor

Syntax	No. of bits		Mnemonic
	Reserved	Information	
Mesh_system_descriptor() {			
descriptor_tag		8	uismbf
descriptor_length		8	uimsbf
superframe_loop_count		8	uimsbf
for (i=0; i < superframe_loop_count; i++) {			
superframe_sequence		8	uimsbf
transponder_freq_offset		40	uimsbf
mesh_frame_loop_count	3	5	uimsbf
for (i=0; i < mesh_frame_loop_count; i++) {			
frame_no	3	5	bsblf
}			
}			
}			

Semantics for the Mesh_system_descriptor:

- **descriptor_tag:** The descriptor tag is an 8 bit field which identifies the descriptor;
- **descriptor_length:** The descriptor length is an 8 bit field specifying the number of bytes of the descriptor immediately following the descriptor_length field. If the descriptor_length field indicates '0' it shall be assumed that all superframes and frames are used for Mesh;
- **superframe_loop_count:** This is an 8-bit field containing one less than the number of superframes containing mesh marked carriers;
- **superframe_sequence:** As in SCT definition;
- **transponder_freq_offset:** This is a 40-bit field containing the signed value of transponder frequency offset for the superframe identified with superframe_id;
- **mesh_frame_loop_count:** This is an 8-bit field containing one less than the number of mesh marked carriers in the superframe;

- `frame_no`: This 5-bit field specifies the frame number within the superframe, referring to the frame numbering convention defined in clause 7.5.1.

6.4.17.31 Extension Protocol descriptor (optional)

The Extension Protocol Descriptor is used to indicate the connection details for an extension protocol. The descriptor is defined in table 6-94.

Table 6-94: Syntax of the Extension Protocol descriptor

Syntax	No. of bits		Mnemonic
	Reserved	Information	
Extension_protocol_descriptor() {			
descriptor_tag		8	uimsbf
descriptor_length		8	uimsbf
extension_protocol_id		8	uimsbf
extension_protocol_version		8	uimsbf
mcast_ipv4_address		32	uimsbf
server_ipv4_address		32	uimsbf
mcast_port		16	uimsbf
server_ucast_port		16	uimsbf
}			

Semantics for the Extension_Protocol_descriptor:

- `descriptor_tag`: The descriptor tag is an 8 bit field which identifies the descriptor;
- `descriptor_length`: The descriptor length is an 8 bit field specifying the number of bytes of the descriptor immediately following the `descriptor_length` field;
- `extension_protocol_id`: This is an 8-bit field containing extension protocol to be used. The field is coded according to table 6-95;

Table 6-95: Extension protocol coding

Extension_protocol_id	Extension protocol	Comment
0	Dynamic Connectivity Protocol L2	DCP over Layer 2
1	Dynamic Connectivity Protocol IP	DCP over Layer 3
2	Mobility control	
3	Management and Control	
4 to 127	Reserved	
128 to 255	User defined	

- `extension_protocol_version`: The protocol version number in one byte notation;
- `mcast_ipv4_address`: This is a 32 bit IPv4 multicast address used for the protocol;
- `server_ipv4_address`: This is a 32 bit IPv4 unicast address used for the protocol;
- `mcast_port`: This is an UDP port for the IPv4 multicast address used for the protocol;
- `server_ucast_port`: This is an UDP port for the IPv4 unicast address used for the protocol.

6.4.17.32 Continuous Carrier Control Descriptor (optional)

This descriptor provides parameters used for configuring and confirming the characteristics of continuous-carrier return link transmissions.

Table 6-96: Syntax of the Continuous Carrier Control descriptor

Syntax	No. of bits		Information Mnemonic
	Reserved	Information	
cc_control_descriptor() {			
descriptor_tag		8	uimsbf
descriptor_length		8	uimsbf
instruction_type		8	uimsbf
supports_carrier_requests	2	1	bslbf
early_user_data_allowed		1	bslbf
split_SDU_allowed		1	bslbf
supports_capacity_requests		1	bslbf
return_to_ready_for_TDMA_sync_allowed		1	bslbf
return_to_TDMA_sync_allowed		1	bslbf
if ((instruction_type > 0x0f) && (instruction_type < 0x20)) {			
frame_number		8	uimsbf
tx_type		8	uimsbf
version_sum		8	uimsbf
}			
if (instruction_type == 0x12 instruction_type == 0x20) {			
countdown_length	4	4	uimsbf
}			
if (instruction_type == 0x20) {			
assignment_persistence		8	uimsbf
}			
if (instruction_type > 0x7f) {			
user_defined		nx8	See text
}			
}			

Semantics for the cc_control_descriptor:

- descriptor_tag: The descriptor tag is an 8 bit field which identifies the descriptor type. The value is given in table 6-2;
- descriptor_length: The descriptor length is an 8 bit field specifying the number of bytes of the descriptor immediately following the descriptor_length field;
- instruction_type: This 8 bit field specifies the type of CC control command contained in the descriptor. The values for valid commands are specified in table 6-97;

Table 6-97: CC control instruction types

Message ID	Instruction
0x00	Reserved
0x01	Receiver acquisition confirmation
0x02	Request for accrued timing offset report
0x03	Request for accrued frequency offset report
0x04 to 0x0f	Reserved
0x10	Persistent assignment
0x11	Persistent carrier revocation
0x12	Persistent mode tx_type change
0x13	Persistent mode termination
0x14 to 0x1f	Reserved
0x20	Configuration
0x21 to 0x7f	Reserved
0x80 to 0xff	User defined

- supports_carrier_requests: When set to "1", this flag indicates that the NCC supports carrier requests as specified in clause 7.2.6.3.5. When set to '0', the NCC may ignore such requests;

- **early_user_data_allowed:** When set to "1", this flag indicates that the RCST may start transmitting applications data on the continuous carrier as soon as the assignment takes effect. When set to "0", the RCST shall wait for acquisition confirmation before transmitting any data other than requests for acquisition confirmation;
- **split_sdu_allowed:** When set to "1", this flag indicates that the receiver can accept SDUs that are fragmented such that some parts are sent over the CC, while others are sent over TDMA. The value "0" indicates that such splitting is not supported by the receiver;
- **supports_capacity_requests:** When set to "1", this flag indicates for non-persistent mode that the NCC supports capacity requests as allowed in the lower layer service descriptor specified in clause 6.4.17.17, when assigned a CC. For an RCST operating in persistent CC mode this parameter is reserved;
- **return_to_ready_for_TDMA_sync_allowed:** When set to "1", this flag indicates that the RCST may, when leaving the CC mode, proceed to the "Ready for TDMA Sync" state, rather than the "Ready for Logon" state, see clause 9.2.8;
- **return_to_TDMA_sync_allowed:** When set to "1", this flag indicates that the RCST may, when leaving the CC mode, proceed to the "TDMA Sync" state, rather than the "Ready for Logon" state, see clause 9.2.8;
- **frame_number:** This 8-bit field indicates the frame number in the superframe to which the persistent assignment applies;
- **tx_type:** This 8-bit field identifies a specific broadcast transmission format specification that refers to a continuous carrier. The value zero is reserved and cannot be used to refer to a broadcast configuration;
- **version_sum:** Modulo-256 sum of the version numbers of the SCT, FCT2 and BCT that applies as reference for the assignment;
- **countdown_length:** The duration, in carrier frames, of the countdown period towards implementing a change of tx_type in the continuous carrier. A value of 0 indicates that no countdown is required;
- **assignment_persistence:** Duration of a non-persistent assignment, in superframe periods;
- **user_defined:** User-defined continuous-carrier control parameter field that occupies an integer number of bytes.

6.5 Transmission of Forward Link L2S Data Structures

The term "bit 0" refers to the least significant bit of a multi-bit field. The most significant bit of a k-bit unsigned value field is designated "bit k - 1". For a signed value field, "bit k - 1" is the sign bit and "bit k - 2" the most significant magnitude-related bit.

Each top level L2S data structure aggregate shall be transmitted as an SDU in the lower layers, organized as follows:

- 1) Fixed fields in a data structure shall be transmitted in the order they are listed, from top to bottom.
- 2) A contiguous sequence of fields as an iteration of a field type shall be transmitted in the order of iteration.
- 3) Relocatable fields in a flexible data structure may be transmitted in any order if not explicitly stated otherwise.
- 4) Reserved bits associated to a field shall be transmitted before the information bits of the same field.
- 5) Multi-bit fields shall be transmitted in bit order starting with the bit considered most significant and ending with the bit considered least significant.

7 Return Link and Mesh Uplink

7.0 Introduction

The Return Link access is based on the Multi-Frequency Time Division Multiple Access (MF-TDMA) scheme. MF-TDMA allows a group of RCSTs to communicate with the NCC and a gateway sharing a set of carrier frequencies,

each of which is divided into timeslots for burst transmission, as described in detail in clause 7.5. Mesh Link access is based on the same type of MF-TDMA transmission aimed not necessarily at a gateway but directly towards another RCST. RCST support of Mesh Link access is an option.

The return link can optionally use a Continuous Carrier (CC) instead of MF-TDMA. This feature is defined in clause 7.6.

The NCC may allocate timeslots for return link bursts for dedicated access, as well as for random access, and indicate the type of burst and content to be transmitted. The resulting Burst Time Plan (BTP) shall be distributed to the RCSTs via broadcast of the SCT, the FCT2, the BCT and the TBTP2 service information tables, and via TIM-U, as applicable.

Table 7-1 gives an overview of the different sub-layers and the location of the respective specification. The table also highlights which functionalities can be considered part of the RLE protocol.

Table 7-1: Return Link Overview and Index

Layers in the protocol stack			
	Topic addressed	Section	
Link Layer/Logical Link Control			
	High Layers Data Unit Transport	7.1.1 SDU Transport in the Return Link 7.1.2 Maximum Transfer Unit for an SDU in the Return Link	
Link Layer/Medium Access Control			
Return Link Encapsulation (RLE)	SDU Encapsulation	7.2.1 The Addressed Link PDU (ALPDU) 7.2.1.1 Addressed Link PDU Format and Syntax 7.2.1.2 The ALPDU Label	
		Mapping to Payload and Fragmentation	7.2.1.3 Identifying the Transmission Resources for the ALPDU 7.2.1.4 Mapping the ALPDU to Available Payload 7.2.1.4.1 Forwarding the ALPDU in One Payload-adapted PDU 7.2.1.4.2 Forwarding the ALPDU Using Several Payload-adapted PDUs 7.2.1.4.3 Integrity Protection of a Fragmented ALPDU 7.2.1.4.4 Multiplexing Payload-adapted PDUs used for Different ALPDUs
			Fragment
	Payload		7.2.3 The Frame PDU 7.2.3.1 Context Differentiation of the Frame PDU 7.2.3.2 The Frame PDU Format and Syntax 7.2.3.3 The Payload Label
			Lower Layer Addressing
		Random Access	
	Dedicated Access		
			Resource Allocation
		Physical layer	
		Transmission Burst Content	7.3.1 Transmission Burst Content Type
		Waveform generation	7.3.2 Burst Waveform
		Energy dispersal	7.3.3 Energy Dispersal
Frame CRC		7.3.4 Payload CRC	
Channel Coding and Interleaving		7.3.5 Coding and Interleaving 7.3.5.1 The Turbo FEC Encoder for Linear Modulation 7.3.5.2 Convolutional Encoder for CPM	
		Inclusion of Known Symbols; Burst Construction	7.3.6 Inclusion of Known Symbols 7.3.6.1 Burst Construction for TC-LM and SS-TC-LM 7.3.6.2 Burst Construction for CC-CPM
Modulation			7.3.7 Modulation 7.3.7.1 Linear Modulation of Burst 7.3.7.2 Continuous Phase Modulation of Burst
		Power	7.3.8 Burst Transmission Power Envelope
Synchronization		7.3.9 Transmission Burst Timing	

Layers in the protocol stack			
	Topic addressed	Section	
		7.3.9.1 Burst Transmission Start Accuracy	
		7.3.9.2 Symbol Clock Accuracy	
		7.3.9.3 Carrier Frequency Accuracy	
	Access Channels		7.5 The Return Link Structure (MF-TDMA)
			7.5.1 Segmentation of the Return Link Resources
			7.5.1.1 Superframe
			7.5.1.2 Superframe Sequence
			7.5.1.3 Frame
			7.5.1.4 Timeslot
			7.5.2 Guard Time
			7.5.3 The Dynamic MF-TDMA Transmission Channel
			7.5.4 Frequency Range of the Dynamic Transmission Channel
			7.6 Return Link Continuous Carrier

7.1 Return Link Logical Link Control

7.1.0 Introduction

The Return Link Logical Link Control layer supports uni-directional connection-less transport, and multiplexes different packet-based protocols over the return link.

7.1.1 SDU Transport in the Return Link

The lower layers receive from the higher layers an SDU of a known type, for transmission on the satellite interface.

The protocol type of the SDU may either directly indicate the protocol type of the PDU to be transferred similar to the Ethertype in Ethernet packets in which case the values are in the range 0x600 (1 536 decimal) up to 0xFFFF, or, for values from 0 to 1 535 decimal may indicate the presence of a header extension in the SDU similar as for the forward link. The same protocol types as for the forward link are recognized for the return link, as indicated in table 5-1.

The RCST shall support transmission and reception of IPv4 PDUs as SDUs and shall also support transmission and reception of IPv6 PDUs as SDUs. The RCST may support a mix of IPv4 and IPv6 PDUs as SDUs.

The RCST should avoid or sufficiently limit transmission of SDUs of any protocol types other than those explicitly indicated as supported by the return link receiver, by administrative configuration. The whole SDU or parts of the SDU may be discarded by the receiver when receiving an SDU of a protocol type that is not explicitly supported. The NCC shall explicitly indicate the default protocol type for the higher layer traffic as specified in clause 6.4.17.14, and the receiver shall as a minimum be capable of receiving SDUs of this protocol type.

The return link receiver should split a link specific header extension from an SDU and recover the embedded higher layer PDU, given that the return link receiver recognizes the specific header extension format and supports the protocol type of the higher layer PDU.

7.1.2 Maximum Transfer Unit for an SDU in the Return Link

The MTU used for the return link shall be:

- a) 512 for lower layer signalling unless bound to a lower value by the specific transmission format;
- b) for other traffic either 1 500 bytes or as indicated by administrative means, if this is larger than 1 500 bytes.

7.2 Return Link Medium Access Control

7.2.0 Introduction

The Return Link Medium Access Control for burst transmission transforms the SDU into an Addressed Link PDU (ALPDU), sections the ALPDU into one or more Payload-adapted PDUs (PPDUs) as required, and assembles PPDUs into Frame PDUs that fit into burst payload.

7.2.1 The Addressed Link PDU (ALPDU)

7.2.1.0 Introduction

The RCST shall build Addressed Link PDUs that, in addition to the SDU, may include an explicit protocol type indication and an explicit address tag in a similar structure as for GSE as specified in ETSI TS 102 606 [8]. When both fields are included the label field is appended after the protocol type field and before the SDU. Both fields are optional. The ALPDU may have a non-zero size protection field (called PRO in figure 7-1). This is illustrated in figure 7-1.

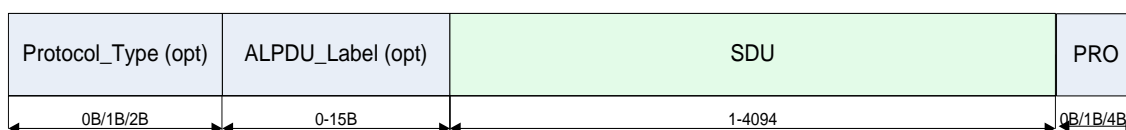

Figure 7-1: Addressed Link PDU Format

The Addressed Link PDU (ALPDU) provides limited explicit integrity protection and thus relies on the integrity protection provided by the lower protocol layers. If the ALPDU fits into a single PDU at the lower layers, it is not provided with a protection (PRO) parameter field. When fragmented into multiple next layer PDUs the ALPDU is equipped with an integrity protection parameter field of either 1 byte or 4 bytes.

7.2.1.1 Addressed Link PDU Format and Syntax

7.2.1.1.0 Introduction

The ALPDU format and syntax are defined in table 7-2.

Table 7-2: Addressed Link PDU Format and Syntax

Syntax	No. of bits		Mnemonic
	reserved	info	
addressed_link_pdu() {			
if (protocol_type_suppressed = 0) {			
if (protocol_type_compressed = 1) {			
compressed_protocol_type		8	uimsbf
for (i = 0; i < length[alpdu_label_type]; i++) {			
alpdu_label_byte		8	bslbf
}			
if (compressed_protocol_type = 0xff) {			
protocol_type		16	uimsbf
}			
else {			
protocol_type		16	uimsbf
for (i = 0; i < length[alpdu_label_type]; i++) {			
alpdu_label_byte		8	bslbf
}			
}			
else {			
for (i = 0; i < length[alpdu_label_type]; i++) {			
alpdu_label_byte		8	bslbf
}			
}			
for (i = 0; i < N1; i++) {			
sdu_byte		8	bslbf

Syntax	No. of bits		Mnemonic
	reserved	info	
}			
if (fragmented_alpdu) {			
if (use_alpdu_crc = 1) {			
alpdu_crc		32	rpchof
}			
else {			
sequence_number		8	uimsbf
}			
}			
}			
NOTE 1: length[alpdu_label_type] is the number of bytes in the ALPDU label.			
NOTE 2: N1 is the number of bytes in the SDU.			

The semantics for the addressed_link_pdu (ALPDU) parameters are specified in the following clauses. The specific values for the control parameters for the ALPDU structure are partly given by the specific START PPDU for the respective link PDU, partly by NCC instruction and partly by more dynamic conditions like e.g. contiguous payload availability and SDU size.

7.2.1.1.1 compressed_protocol_type Field

This 8 bit field is present in the link PDU as instructed by the NCC, if not explicitly indicated to be suppressed by the Protocol Type Suppressed flag.

If present, the field shall explicitly indicate the protocol type of the SDU by its compressed equivalent or it shall alternatively indicate the presence of a trailing full size protocol type field. The compressed protocol type field can have these different lengths as indicated by the NCC and the value of the Protocol Type Suppressed flag (provided by PPDU):

- **1 byte.** This is a compressed protocol type with a value according to table 7-3.
- **0 byte.** The protocol type of the SDU is the implicit protocol type indicated by the NCC unless the protocol type is implied by the specific ALPDU Label Type value used (as provided by PPDU).

Table 7-3: Compressed protocol type values

Compressed protocol type value	Corresponding protocol type value for ALPDU CRC calculation, and for protocol reference	Protocol (see the SDU protocol list for reference, table 5-1)
0x00	0x0000	
0x01	0x0001	
0x02	0x0002	
0x03	0x0003	
0x04	0x00C8	
0x05	0x0100	
0x06	0x0200	
0x07	0x0300	
0x08	0x0301	
0x09	0x03C3	
0x0A	0x0400	
0x0B	0x04C2	
0x0C	0x0500	
0x0D	0x0800	
0x0E	0x0806	
0x0F	0x8100	
0x10	0x22F1	
0x11	0x86DD	
0x12	0x8809	
0x13	0x8847	
0x14	0x8848	
0x15	0x8863	
0x16	0x8864	
0x17	0x888E	

Compressed protocol type value	Corresponding protocol type value for ALPDU CRC calculation, and for protocol reference	Protocol (see the SDU protocol list for reference, table 5-1)
0x18	0x8906	
0x19	0x88A8	
0x1A	0x9100	
0x1B-0x2F		Reserved
0x30	0x0800 or 0x86DD; corresponding to IP version	Common indicator for IPv4 and IPv6; requires version inspection
0x31	0x8100	The same as 0x0F with the 2 byte protocol type field omitted; limited to IPv4 and IPv6 as the alternatives for the trailing PDU
0x32 to 0x41		Reserved
0x42	see SDU protocol list, table 5-1	Internal M&C signalling (L2S)
0x43		Chaff filling in connection with TRANSEC, refer to ETSI TS 101 545-1 [i.15]
0x44		X.509 certificate exchange, refer to ETSI TS 101 545-1 [i.15]
0x45	see SDU protocol list, table 5-1	TRANSEC System Protocol, refer to ETSI TS 101 545-1 [i.15]
0x46	see SDU protocol list, table 5-1	Encrypted layer 2 payload, refer to ETSI TS 101 545-1 [i.15]
0x47	see SDU protocol list, table 5-1	Dynamic Control protocol, refer to ETSI TS 101 545-3 [i.16]
0x48 to 0x7F		Reserved
0x80 to 0xFE	User Defined	User Defined
0xFF	value in adjacent 2 byte protocol type field	according to protocol type indicated

The compressed protocol type value 0xFF is reserved to indicate a construction with insertion of a 2 byte protocol type field after the ALPDU label, intended to support indication of any SDU which immediately follow this protocol type field, and to support the utilization of extension headers together with the compressed protocol type.

7.2.1.1.2 `protocol_type` Field

This 16 bit field is present in the ALPDU if not explicitly indicated to be suppressed by the Protocol Type Suppressed flag (provided by PPDU) or excluded by use of other compressed protocol types than one indicating inclusion of the full size protocol type.

The `Protocol_Type` field may explicitly indicate the protocol type of the SDU, using the same protocol type values as used for the forward link as specified in clause 5. It may alternatively indicate the presence of header extension, used as specified in clause 5. The field may have these different lengths as indicated by the NCC and the value of the Protocol Type Suppressed flag (provided by PPDU):

- **2 bytes in network byte order.** A value according to the list of supported SDU protocols. The RCST will use one of the values listed in table 5-1 when indicating an SDU for one of the protocols listed, and may use other values to indicate an SDU of a protocol not listed.
- **0 byte.** The protocol type of the SDU is the implicit protocol type indicated by the NCC unless the specific protocol type is implied by the specific ALPDU Label Type value used (as provided by the PPDU).

7.2.1.1.3 `alpdu_label_byte` Field (optional)

The `alpdu_label_byte` field is one byte of the ALPDU label.

The length of the ALPDU label is indicated in the PPDU by the ALPDU Label Type value, possibly through reference to a length value given by the NCC. See the specification of the ALPDU Label Type in clause 7.2.2.4.

7.2.1.1.4 `sdu_byte` Field

This 8 bit field holds one byte from the complete contiguous sequence of SDU bytes.

7.2.1.1.5 fragmenting_alpdu

This control parameter is local to the transmitter and reflects whether the ALPDU is mapped into one payload adapted PDU or fragmented into multiple such PDUs. A trailing field for integrity protection is included when the ALPDU is fragmented for adaptation to the next layer, and excluded when the ALPDU is contained within a single next layer PDU.

7.2.1.1.6 sequence_number Field

The 8 bit `sequence_number` field may be included at the end of the ALPDU and it is mutually exclusive with use of the `alpdu_crc` field.

The presence of the sequence number in the ALPDU is indicated by the value 0 in the `use_alpdu_crc` field of the corresponding START PPDU. Allowance to apply the ALPDU Sequence Number is explicitly indicated by the NCC. The RCST shall not apply the ALPDU Sequence Number if not explicitly allowed by the NCC.

The transmitter shall use an incrementing sequence number independently per `fragment_id`. The first sequence number used for a `fragment_id` after logon shall be the value zero. It shall be incremented by one for each ALPDU sent using the respective `fragment_id`, and it shall be calculated modulo 256.

7.2.1.1.7 alpdu_crc Field (optional)

This 32 bit field may be included in the ALPDU and it is mutually exclusive with the `sequence_number` field. It carries the ALPDU CRC.

The presence of the ALPDU CRC is indicated by the value 1 in the `use_alpdu_crc` field of the corresponding START PPDU. Allowance to apply the ALPDU CRC is explicitly indicated by the NCC. The RCST shall not apply the ALPDU CRC if not explicitly allowed by the NCC.

The CRC is calculated as for the GSE end packet CRC in the forward link, including the same components in the same order.

7.2.1.2 The ALPDU Label

The RCST shall be capable of issuing an ALPDU Label of one byte size when the ALPDU Label Type '0' has been configured by the Frame Payload Format descriptor to a size of 1 byte. The ALPDU label of 1 byte size shall contain the most significant byte of the unicast MAC24 assigned to the interface in the Logon Response Descriptor. The ALPDU label may be omitted if the SVN number of the interface is equal to the default SVN number indicated by the Logon Response descriptor. The size, format and syntax used in the different transmission contexts and payload types are shown in table 7-4. Other use is reserved.

Table 7-4: ALPDU Label Size, Format and Syntax

Transmission Context	Payloads for Traffic
Transparent star, dedicated access	0/1 byte; most significant byte of unicast MAC24 if 1 byte
Transparent star, random access	0/1 byte; most significant byte of unicast MAC24 if 1 byte
Transparent mesh overlay	3 bytes for destination MAC24
Regenerative mesh	3 bytes for destination MAC24

7.2.1.3 Identifying the Transmission Resources for the ALPDU

The RCST shall determine which of the available resources are useful for a specific ALPDU. The NCC shall indicate which resources are available for dedicated access by the RCST through reference to one or more Assignment IDs dedicated to the RCST at the time of logon. The NCC also indicates the resources available for random access and the random access method using SCT/FCT2/BCT and optionally in combination with the TBTP2.

The NCC shall indicate a mapping of a traffic aggregate to an Assignment ID by indicating a nominal mapping of each assigned request class to an Assignment ID in the Lower Layer Service descriptor. By default, an RCST shall assume that resources assigned to any of its Assignment IDs are useful for any transmission to the gateway. An RCST may be implemented with functionality to map specific traffic aggregates to specific Assignment IDs. Such functionality and

the supplemental protocols required to support configuration of such mappings are out of scope for the present document, and may be found in ETSI TS 101 545-3 [i.16].

The RCST shall support assignment to at least three Assignment IDs as assigned at logon.

7.2.1.4 Mapping the ALPDU to Available Payload

7.2.1.4.0 Introduction

The RCST shall fragment an ALPDU into Payload-adapted PDUs as necessary to fit these PPDU into transmission frames that the NCC has assigned, aimed for the receivers targeted by the ALPDU.

7.2.1.4.1 Forwarding the ALPDU in One Payload-adapted PDU

The ALPDU may be transmitted in full in a single PPDU if the payload can hold the PPDU.

7.2.1.4.2 Forwarding the ALPDU Using Several Payload-adapted PDUs

The ALPDU may be fragmented and mapped into a sequence of a start PPDU, optionally a number of intermediate PPDU and an end PPDU finalizing the transport of the ALPDU. These PPDU shall all be tagged with the same Fragment ID value.

The Fragment ID values shall be managed in the context of the transmitter. Each fragment of an ALPDU shall be transmitted in a PPDU tagged with the same Fragment ID value as the PPDU carrying other fragments of the same ALPDU. The fragments of an ALPDU shall be transmitted in their natural sequence, with the header fragment first.

7.2.1.4.3 Integrity Protection of a Fragmented ALPDU

A transmitter shall use either the ALPDU CRC method or the ALPDU Sequence Number method for integrity protection at fragmentation of the ALPDU onto several PPDU. The RCST shall use a method explicitly allowed as indicated by the NCC.

A transmitter shall associate an independent 8 bit wrapping counter with each Fragment ID value. The counter shall initialize to zero at logon to the NCC. The counter value shall be appended as the ALPDU Sequence Number to the END PPDU before incrementing the counter by one to provide the value for the next end PPDU tagged with the same Fragment ID value.

The 32-bit link PDU CRC shall be calculated using the algorithm specified for the end GSE packet as used in the forward link. It is to be computed over a possibly expanded ALPDU constituted by the concatenation of the corresponding 16-bit SDU protocol type (even if suppressed or compressed) and the optional ALPDU label if present.

7.2.1.4.4 Multiplexing Payload-adapted PDUs used for Different ALPDUs

A transmitter may multiplex PPDU associated to different ALPDUs even if all of the PPDU carry fragments of different ALPDUs, as long as each of the ALPDUs not yet finalized by an end PPDU is associated with a Fragment ID value that is not associated to any other ALPDU in progress from the transmitter. An ALPDU in progress is associated to a start PPDU transmitted earlier but the ALPDU is not yet finalized by transmission of an END PPDU.

A PPDU both starting and finalizing a complete ALPDU may be sent anywhere in a sequence of PPDU.

7.2.2 The Payload-adapted PDU (PPDU)

7.2.2.0 Introduction

The RCST transmitter shall use a Payload-adapted PDU (PPDU) format complying with this clause as instructed by the NCC in the Frame Payload Format descriptor.

An ALPDU shall be transported by using one or more PPDU.

This set of 4 PPDU types is defined:

- FULL PDU: the PDU type for an unfragmented ALPDU
- START PDU: the first PDU for an ALPDU that utilizes several PDUs
- CONTINUATION PDU: the PDU for an ALPDU fragment that is a continuation of an ALPDU, following in time the preceding adjacent ALPDU fragment transmitted in an earlier PDU
- END PDU: the PDU that finalizes an ALPDU

The different PDU formats are illustrated in figure 7-2.

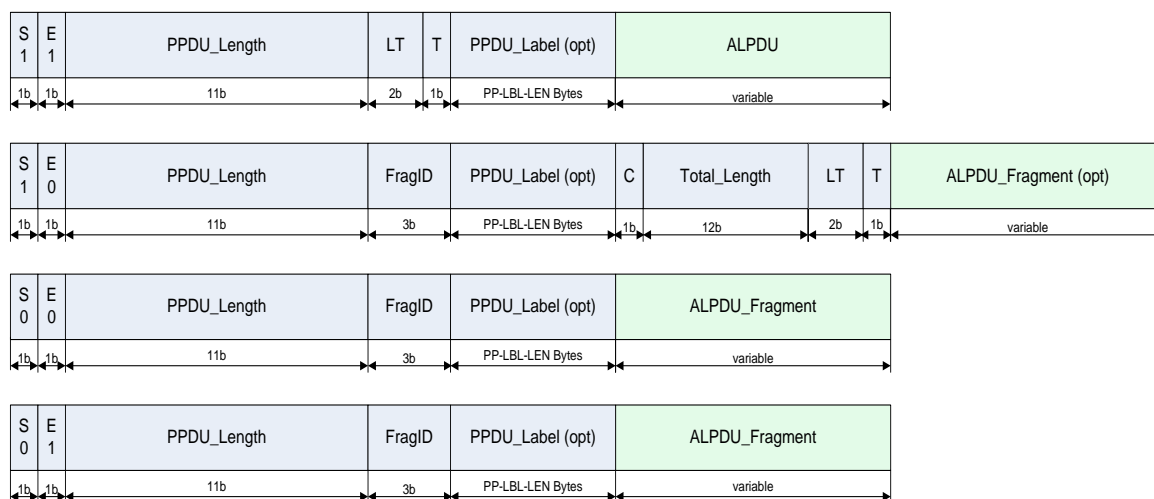

Figure 7-2: Payload-adapted PDU Formats

The PDU has a first header of two bytes which is present in all PDU types. These two bytes start with two bits that indicate the type of the PDU and that have the same semantics as for the protocol specified for the GSE protocol in ETSI TS 102 606 [8]. These two bits are followed by a length field of 11 bits that indicates the length of the varying length part of the PDU. The meaning of the remaining three bits differ: for a PDU with an unfragmented ALPDU these bits contain the ALPDU Label Type field (two bits) and the Protocol Type Suppression flag. For the other PDU types these three bits contain the Fragmentation ID field.

The two-byte first header of the PDU is immediately followed by the optional PDU label, if this is present.

The remainder of the PDU content depends on the values of the `start_indicator` and `end_indicator`. This is described in the following clauses.

The START PDU is never less than 4 bytes due to a second header of 2 bytes following after the optional PDU label. The presence of an ALPDU section is optional both in the START PDU and the END PDU as well as in a FULL PDU, but an ALPDU section is required in a CONTINUATION PDU to avoid the situation that this PDU resembles the start of payload padding in the position of the first header.

NOTE: There may be implementations of the specifications in the present document that require the RCST to avoid splitting the 4 last bytes in the ALPDU across Frame PDUs, when these 4 bytes are used for the CRC32.

The 2 byte PDU header containing the value 0x0000 indicates start of Frame PDU padding.

The format and syntax of the PDU is specified in table 7-5.

Table 7-5: Payload-adapted PDU Format and Syntax

Syntax	No. of bits		Mnemonic
	Reserved	Information	
<code>payload_adapted_pdu() {</code>			
<code>start_indicator</code>		1	bslbf
<code>end_indicator</code>		1	bslbf
<code>ppdu_length</code>		11	uimbsf

Syntax	No. of bits		Mnemonic
	Reserved	Information	
if (start_indicator = 1 and end_indicator = 1) {			
alpdu_label_type		2	uimbsbf
protocol_type_suppressed		1	bslbf
}			
else {			
fragment_id		3	uimbsbf
}			
for (i = 0; i < M; i++) {			
ppdu_label_byte		8	uimbsbf
}			
if (start_indicator = 1 and end_indicator = 0) {			
use_alpdu_crc		1	bslbf
total_length		12	uimbsbf
alpdu_label_type		2	uimbsbf
protocol_type_suppressed		1	bslbf
}			
for (i = 0; i < N; i++) {			
alpdu_byte		8	bslbf
}			
}			
NOTE 1: M is the number of PPDU label bytes that applies for all the PPDUs in the payload carrying this PPDU.			
NOTE 2: N is the number of bytes in the ALPDU section carried by the specific PPDU, and the section may be any fragment of the ALPDU or the complete ALPDU.			

The semantic of the fields of the payload_adapted_pdu and the corresponding rules are explained in the following clauses.

7.2.2.1 start_indicator and end_indicator Fields

These are both 1 bit fields and appear in all PPDUs.

A value of "1" in the Start Indicator position indicates that the PPDU contains the initiation of transport of an ALPDU. A value of "0" indicates that the PPDU either contains an intermediate section or finalizes an ALPDU where earlier sections of the ALPDU are contained in PPDUs transmitted earlier in the PPDU sequence, if not indicating start of padding.

A value of "1" in the End Indicator position indicates that the PPDU contains the finalization of an ALPDU. A value of "0" indicates either an intermediate section of an ALPDU or the initialization of an ALPDU, if not indicating padding.

If both start and end indicators are "0", the PPDU Length is "0" and the Fragment ID is "0" this is not a PPDU but instead the start of padding filling the rest of the available transmission frame payload space.

7.2.2.2 ppdu_length Field

This 11 bit field is present in all PPDU types.

The ppdu_length field contains the length of the PPDU exclusive of the two byte PPDU header and exclusive of the PPDU label.

A value of 0 in the PPDU Length field position shall only occur if both the Start Indicator field and the Start Indicator field are 0. This condition together with zero in the Fragment ID field indicates that these fields are not indicating the start of a PPDU but the start of payload padding.

7.2.2.3 fragment_id Field

This 3 bit field is present in all PPDU types but the FULL PPDU.

A receiver shall be able to concurrently receive PPDUs for of up to 8 ALPDUs from each possible transmitter (then all possible Fragment ID values are in use by all possible transmitters).

7.2.2.4 alpdu_label_type Field

This 2 bit field is present in the START PPDU and in the FULL PPDU. It indicates either the length of the ALPDU label or the use of the Frame PDU for internal lower layer signalling without label. There are four possible values that are to be interpreted as shown in table 7-6. The interpretation of three of the values can be aligned with the corresponding GSE field (the GSE 'reuse label' option is not supported). The interpretation to be used is completed by explicit indication from the NCC in the Payload Format Descriptor.

Table 7-6: Indications by the ALPDU Label Type Values

ALPDU label Type value	ALPDU label size (bytes)	Protocol Type to be inferred when not indicated explicitly in the ALPDU
0	Label size as indicated by the NCC	As indicated by the NCC
1	3	As indicated by the NCC
2	0	As indicated by the NCC
3	0	internal lower layer signalling

An essential interpretation is:

ALPDU Label Type = 0 => 1 byte ALPDU label

7.2.2.5 protocol_type_suppressed Field

This 1 bit field is present in the START PPDU and in the FULL PPDU.

The inclusion of the `Protocol_Type` field in the ALPDU is indicated by the Protocol Type Suppressed flag set to "0".

The omission of the `Protocol_Type` field, and thus the use of an implicit protocol type for the SDU is indicated by the Protocol Type Suppressed flag set to "1".

If the SDU is not associated with a specific Protocol Type by either the ALPDU Label Type value or the explicit Protocol Type indication, the protocol type shall be assumed to be the Implicit Protocol Type indicated by the NCC.

7.2.2.6 ppdu_label_byte Field (optional)

This one byte field holds one byte of the PPDU label and may be present in any PPDU type.

The size of the PPDU labels applicable for the PPDUs in a given payload is indicated either explicitly in the optional Frame PDU header or the size that applies for a given payload is as indicated by the NCC. The explicit indication in the Frame PDU header takes precedence.

This field is reserved for future use. Receivers may silently discard the content if the field is present.

7.2.2.7 use_alpdu_crc Field

This one-bit field is present in the START PPDU. It indicates whether the ALPDU Sequence Number or the ALPDU CRC is used. If the bit is set, the ALPDU CRC is included. If the bit is cleared, the ALPDU Sequence Number is included.

7.2.2.8 total_length Field

The 12 bit `total_length` field is present in the START PPDU. It indicates the size of the ALPDU. The field size allows a maximum size of 4 095 bytes. Further, the ALPDU shall not be larger than the maximum size allowed as indicated by the NCC.

7.2.2.9 alpdu_byte Field

This field represents one single byte of the ALPDU from the section of contiguous ALPDU bytes contained in the given ALPDU. The ALPDU is specified in table 7-2. An ALPDU may be fragmented into contiguous sections where the first

section is put into one PPDU, the next section into another PPDU transmitted later and so forth until the transmission of the ALPDU is finalized.

7.2.2.10 The PPDU Label (optional)

The size, format and syntax of the PPDU label to be used for the different payload content types and transmission contexts are shown in table 7-7.

Table 7-7: PPDU Label Size, Format and Syntax

Transmission Context	Payload for Traffic
Transparent star, dedicated access	No PPDU Label
Transparent star, random access	No PPDU Label
Transparent mesh overlay	No PPDU Label
Regenerative mesh	No PPDU Label

7.2.3 The Frame PDU

7.2.3.1 Context Differentiation of the Frame PDU

The RCST transmitter shall build transmission frame payload as instructed by the NCC. Different transmission contexts may use different variants of frame payload structure. The NCC may give different instructions for the variant-configurable transmission contexts.

The transmission contexts that shall be recognized implicitly via the NCC control signalling are permutations of:

- The indicated TDMA access method being random access or dedicated access.
- The specific TDMA random access method.
- Transmission format type being TDMA or continuous carrier.
- The content type for the transmission.

An RCST shall comply with the payload format configurations indicated for those transmission contexts that it supports.

Additional context differentiation may be implemented under control of a supplemental protocol, used e.g. to support transparent mesh communication and mesh communicating via a regenerative satellite. This is out of scope for the present document.

The generic structure of the Frame PDU for a frame that supports transport of user traffic is illustrated in figure 7-3.

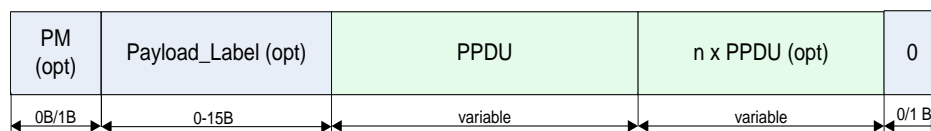

Figure 7-3: Frame PDU Format for a Frame Supporting User Traffic

The generic structure of the Frame PDU for a frame that is dedicated by the NCC to transport only internal signalling is illustrated in figure 7-4. The generic structure shown in figure 7-3 is rationalized relative to figure 7-4 by exploiting the context to omit the PPDU header, the ALPDU header and the protocol type.

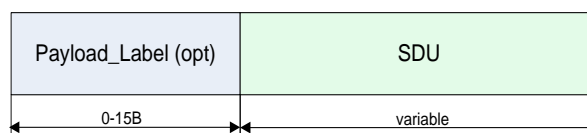

Figure 7-4: Frame PDU Format for a Frame Dedicated to Internal Signalling (Logon and Control)

7.2.3.2 The Frame PDU Format and Syntax

The transmission Frame PDU format and syntax for a frame for user traffic shall be in accordance with table 7-8. Used in an MF-TDMA context the present document concerns the payload of the burst. Used in a TDM context the present document concerns the payload of the TDM frame.

Table 7-8: User Traffic Transmission Frame PDU Format and Syntax

Syntax	No. of bits		Mnemonic
	Reserved	Information	
traffic_frame_pdu() {			
if (use_explicit_payload_header_map = 1) {			
payload_label_length		4	uismbf
ppdu_label_length		4	uismbf
}			
for (b = 0; b < payload_label_length; b++) {			
payload_label_byte		8	bslbf
}			
for (j = 0; j < N1; j++) {			
for (i = 0; i < X1(j); i++) {			
ppdu_byte		8	bslbf
}			
}			
for (p = 0; p < P1; p++) {			
padding_byte		8	bslbf
}			
if (not_byte_aligned) (k = 0; k < K1; k++){			
padding_bit		1	bslbf
}			
NOTE 1: The value of use_explicit_payload_header_map is indicated by the NCC in the Frame Payload Format Descriptor.			
NOTE 2: P1 is the number of complete padding bytes required to fill the frame payload.			
NOTE 3: N1 is the number of PPDU in the payload, X1(j) is the number of bytes occupied by PPDU 'j'.			
NOTE 4: The value of use_frame_crc is indicated by the NCC.			
NOTE 5: K1 is less than 8 and is the number of bits required to fill the payload.			

The size of the transmission frame payload is given by the construction of the physical layer, and may differ between the different transmission modes.

The semantics of the traffic_frame_pdu fields are defined in the following paragraphs:

- payload_label_length: This 4-bit field specifies the length of the Payload Label in bytes. This allows Payload Label sizes from 0 to 15 bytes. If both the Payload Label Length and the PDU Label Length are constant for a given transmission context these may be signalled out-of-band by the NCC and may then be omitted from the payload header;
- ppdu_label_length: This 4-bit field specifies the length of the labels used in the PPDU in the payload, in bytes. This allows PPDU label sizes from 0 to 15 bytes. If both the Payload Label Length and the PPDU Label Length are constant for a given transmission context these may be signalled out-of-band by the NCC and may then be omitted from the payload header;
- payload_label_byte: One byte of the Payload Label. The payload label size is specified by the PayloadLabelLength field or the NCC if the first is not present. The Payload Label can be used to transport information associated to the payload;
- ppdu_byte: A sequence of X1(n) of this 8 bit field contains one PPDU with structure and semantics as specified in the present document. The contiguous section of ppdu_bytes holds N1 complete PPDU;

- padding_byte: One byte from a variable size padding field. Any bytes from this position and up to the Frame PDU end are padding bytes and shall be set to zero. A single remaining byte following in the payload after the last PPDU is padding;
- padding_bit: One bit out of 0-7 padding bits that all shall be set to zero.

The transmission Frame PDU format and syntax for a frame dedicated to internal signalling shall be in accordance with table 7-9.

Table 7-9: Signalling Transmission Frame PDU Format and Syntax

Syntax	No. of bits		Mnemonic
	Reserved	Information	
signalling_frame_pdu() {			
for (b = 0; b < payload_label_length; b++) {			
payload_label_byte		8	bslbf
}			
for (i =0; i < N; i++) {			
sdu_byte		8	bslbf
}			
if (not_byte_aligned) (k = 0; k < K1; k++){			
padding_bit		1	bslbf
}			
NOTE 1: N is the number of bytes occupied by the SDU.			
NOTE 2: K1 is less than 8 and is the number of bits required to fill the payload.			

The size of the transmission frame payload is given by the construction of the physical layer.

The semantics of the traffic_frame_pdu fields are defined in the following paragraphs:

- payload_label_length: The size of the payload label is implicit for the transmission context;
- payload_label_byte: One byte of the payload label;
- sdu_byte: A sequence of N of this 8 bit field contains one signalling SDU with structure and semantics as specified in the present document;
- padding_bit: One bit out of 0-7 padding bits that all shall be set to zero.

7.2.3.3 The Payload Label

The default assumption for the Payload Label format shall be as indicated in table 7-10.

The default assumptions for other contexts than the ones listed are reserved for future definition. The RCST shall be compatible with the listed default assumptions for the applicable transmission contexts.

Table 7-10: Payload Label Size, Format and Syntax

Transmission Context	Logon Burst Payload	Control Burst Payload	Payload for Traffic
Transparent star, dedicated access	No Payload Label	No Payload Label	No Payload Label
Transparent star, Slotted Aloha access	6 bytes; holding the RCST HID of the source	3 bytes; concatenated source Group ID and Logon ID in sequence MSB to LSB	3 bytes; concatenated source Group ID and source Logon ID in sequence MSB to LSB
Transparent star, CRDSA access	8 bytes; Concatenated 6 bytes holding the RCST HID of the source and 2 byte CRDSA tag, in sequence MSB to LSB	5 bytes; Concatenated source Group ID, Logon ID and CRDSA tag, in sequence MSB to LSB	5 bytes; Concatenated source Group ID, source Logon ID and CRDSA tag, in sequence MSB to LSB
Transparent mesh overlay	not applicable	not applicable	2 bytes for transmitter identification
Regenerative mesh	6 bytes; holding the RCST HID of the source	3 bytes; concatenated source Group ID and Logon ID in sequence MSB to LSB	2 bytes for receiver identification

7.2.4 Lower Layer Addressing by the RCST

7.2.4.0 Introduction

A transparent star RCST shall support transmission in a system where neither the Payload Label nor the PPDU Label, nor the ALPDU Label provides space for explicitly identifying the link destination. Generally, an RCST shall be capable of transmitting the ALPDUs in any of the transmission opportunities provided by the NCC that are compatible with the given ALPDU content type, given that the NCC respects the agreed transmission limitations of the RCST, as covered in the present document and valid for the specific RCST. The RCST shall make this association between ALPDUs and available resources by default.

Other associations between ALPDUs and resources may be given to the RCST through a supplemental signalling system or by configuration. This is out of scope for the present document.

7.2.4.1 Addresses used for Lower Layer Signalling towards NCC

The 48 bit non-volatile RCST HID shall be used to explicitly identify the source RCST associated with the contention based logon burst, as defined in clause 5.2.1.

The concatenation of the assigned Group ID as MSB and the assigned Logon ID as LSBs shall be used as identifier for the payload source carrying contention based control signalling. The contention transmission context configuration shall provide space for this identifier in the Payload Label.

Address shall be omitted for the control signalling in exclusively assigned transmission opportunities.

7.2.4.2 Lower Layer Addressing of SDUs

7.2.4.2.0 Introduction

Other schemes than specified in this clause is out of scope for the present document.

7.2.4.2.1 Transparent Star

7.2.4.2.1.1 Explicit ALPDU Source Interface Indication

The ALPDU shall have an ALPDU label that holds a reference to the local ALPDU source interface if the SVN number of this interface is different from the default SVN number as given in the Logon Response Descriptor.

7.2.4.2.1.2 Implicit ALPDU Source/Destination Addresses

Explicit ALPDU source/destination address may be omitted and instead inherited from the PPDU address or the Frame PDU address. The RCST shall support the latter.

7.2.4.2.1.3 Implicit PPDU Source/Destination Addresses

Explicit PPDU source/destination address may be omitted and instead inherited from the Frame PDU address. The RCST shall support this.

7.2.4.2.1.4 Implicit Frame PDU Source/Destination Addresses

The transparent star network uses the gateway as the default destination for transmissions from the RCST, and thus the RCST may be instructed to omit the destination address in the transmission. Support of this is mandatory for the transparent star RCST.

The source address of the payload can be determined from the TBTP2, for the payload in a transmission opportunity assigned exclusively to one RCST. Thus, for transmission in dedicated resources, the RCST shall be capable of omitting the explicit source/destination addresses as applicable for the Payload Label size and format to be used.

7.2.4.2.1.5 Explicit ALPDU Source/Destination Address

Explicit ALPDU source address and destination address may be located in the ALPDU label.

Such use of the ALPDU Label is not mandated by the present document.

7.2.4.2.1.6 Explicit PPDU Source/Destination Addresses (option)

Explicit PPDU addressing may be included but is not utilized by the present document.

7.2.4.2.1.7 Explicit Frame PDU Destination Address (option)

An explicit payload destination address may be located in the Payload Label. This is out of scope for the present document.

7.2.4.2.1.8 Explicit Frame PDU Source Address

A source identifier for the burst transmitter shall be located in the Payload Label of the contention bursts.

The assigned Group ID (GID) as MSB combined with the assigned Logon ID (LID) as LSBs shall be used explicitly for identification of the source RCST in the Payload Label. The context control signalled in the Frame payload format descriptor in the TIM-B shall provide 3 byte of Payload Label space for this identifier.

7.2.4.2.2 Transparent Mesh

7.2.4.2.2.0 Introduction

Addressing schemes other than specified in this clause are optional to support, and thus implementation dependent.

7.2.4.2.2.1 Explicit ALPDU Destination Address

Explicit MAC24 ALPDU destination address shall be included.

7.2.4.2.2.2 Explicit FPDU Source Indication

Explicit 16 bit FPDU source identification shall be included.

7.2.4.2.3 Regenerative Mesh

7.2.4.2.3.0 Introduction

Addressing schemes other than specified in this clause are optional to support, and thus implementation dependent.

7.2.4.2.3.1 Explicit ALPDU Destination Address

Explicit MAC24 ALPDU destination address shall be included.

7.2.4.2.3.2 Explicit FPDU Destination Indication

Explicit 16 bit FPDU destination identification shall be included.

7.2.4.3 Virtual Network Addressing

An RCST shall associate the appropriate SVN number value with each ALPDU and shall insert the least significant SVN number bits in the SVN tag specified for the ALPDU Label, unless the applicable value is equal to the default SVN number and the SVN tag may then be omitted if the ALPDU Label is not required for other purposes. A receiver shall assume the default SVN number of the specific source if there is no explicit SVN tag with the ALPDU. The SVN number for an ALPDU is the one associated with the specific virtual interface submitting the SDU.

7.2.5 Random Access

7.2.5.0 Introduction

The NCC uses the signal specified in clause 6.4.17.17 to instruct the RCST of at least a minimum lower layer service that the RCST needs to communicate with the NCC at higher layers. The NCC may provide the RCST with the complete specification of the lower layer service that it supplies to the RCST via the L2S, or the NCC may provide the RCST with supplemental lower layer service information via higher layer protocols that are out of scope for the present document.

The NCC may provide the RCST with timeslots for random access. Segments of an SDU shall not be sent using RA if at least one segment of the same SDU has been sent or will be sent using DA.

7.2.5.1 Channels for Random Access

7.2.5.1.1 Timeslots for Random Access Logon

Timeslots may be allocated for random access logon bursts as indicated by the SCT/FCT2/BCT and by these in combination with the TBTP2. The RCST shall be capable of utilizing these timeslots.

7.2.5.1.2 Timeslots for Random Access Control (optional)

Timeslots may be allocated for random access control bursts as indicated by the SCT/FCT2/BCT and by these in combination with the TBTP2. The RCST may make use of these timeslots.

7.2.5.1.3 Timeslots for Random Access User Traffic (optional)

Timeslots may be allocated for random access user traffic as indicated by the SCT/FCT2/BCT, or by these in combination with the TBTP2. The RCST may optionally be capable of making use of such timeslots. The RCST shall by default not transmit in contention timeslots for traffic, but may do this when explicitly allowed by indication in the Lower Layer Service Descriptor or by other administrative means.

7.2.5.2 Random Access Methods

7.2.5.2.0 Introduction

Random access transmission is equal to dedicated access transmission with respect to the burst construction and waveform, the timeslot structure and the burst reception, although each timeslot may simultaneously be accessed by any number of the transmitters allowed the service as these are not coordinated in real time. The applications using the interactive network may rely on network internal contention control mechanisms to avoid sustained excessive packet loss resulting from simultaneous destructive transmissions.

Two methods are considered for random access, one called Slotted Aloha and another called Contention Diversity Slotted Aloha. Although these methods are commonly associated with feedback from the receiver and automatic retransmission, such feedback is out of scope for the present document.

7.2.5.2.1 Slotted Aloha

Slotted aloha is a random access method where burst transmissions are sent in predefined timeslots.

An RCST shall support use of slotted aloha logon timeslots. It shall perform the contention control specified in clauses 9.2.3 and 9.7.1.

An RCST may support use of slotted aloha control timeslots. It shall then perform contention control as specified in clause 9.7.2.

An RCST may support use of slotted aloha timeslots for user traffic and may be assigned one or more random access allocation channels for such access. It shall then perform random access load control for each random access channel as specified in clause 9.7.3 according to the method and parameters indicated in the Lower Layer Service descriptor, the RA Method descriptor and the RA Load Control descriptor.

7.2.5.2.2 CRDSA (optional)

7.2.5.2.2.0 Introduction

Contention Resolution Diversity Slotted ALOHA (CRDSA) is based on the transmission of a chosen number of replicas of each burst payload by using slotted aloha in a specific transmission scheme.

There are two possible variants of CRDSA transmitter operation:

- Constant Replication Ratio CRDSA (CR-CRDSA): using a constant number of replicas of each burst;
- Variable Replication Ratio CRDSA (VR-CRDSA): using a varying number of replicas for the different bursts, where the number of replicas is determined according to a pre-defined probability distribution.

The type of CRDSA scheme (CR-CRDSA vs. VR-CRDSA) that is best to use may be chosen on the basis of a trade-off between throughput and burst loss rate. While CR-CRDSA allows low burst loss rate, VR-CRDSA allows larger peak throughput.

7.2.5.2.2.1 Constant Replication Ratio CRDSA (optional)

CRDSA timeslots in a superframe are defined by forward link signalling tables SCT, FCT2, and BCT. The CRDSA timeslots that belong to the same CRDSA channel shall be identified by the same `tx_access_method` value in FCT2 tables. The timeslots of a CRDSA channel shall all have the same timeslot format and waveform.

Instances of a unique payload include the unique payload itself and all of its replicas. The number of instances to be transmitted for each unique payload shall be specified in the RA Traffic Method descriptor for each CRDSA channel. The RCST shall transmit all instances of a unique payload in randomly selected locations within a RA block.

RA blocks shall be specified in the RA Traffic Method descriptor for each CRDSA channel. The timeslots that belong to an RA block belongs to the same CRDSA channel. An RA block shall be entirely contained within one superframe. Multiple RA blocks may be defined for the same CRDSA channel in each superframe. The timeslots that belong to an RA block starts at or after the `block_start_time` indicated in the RA Traffic Method descriptor for the RA block. The timeslots that belong to an RA block ends at or before the `block_end_time` indicated in the RA Traffic Method descriptor for the RA block.

The remaining of this clause describes the normative behaviour of the RCST operation in CRDSA channels.

The RCST shall operate in accordance with the effect of the procedural steps listed below. Each procedural step is further elaborated in the remaining of the text:

- 1) Determine the number of unique payloads to transmit in the RA block.
- 2) Select timeslot locations. Timeslot locations within an RA block are numbered sequentially in the RA block context from 0 (lowest in carrier frequency and first in time) to K (highest in carrier frequency and last in time), ordered in falling precedence first according to ascending carrier frequency and then according to ascending time. For each unique payload, select a number, designated *nofInstances*, of timeslot locations in the RA block. Store these locations in an array, designated *locArray*, together with the random seed, designated *numRand*, that was used to determine the timeslot locations for the respective unique payload.
- 3) Associate timeslot locations and random seeds to unique payloads.
- 4) Transmit instances within the RA block.

Each procedural step listed above is further elaborated below.

Step-1: Determine the number of unique payloads to transmit in the RA block.

The maximum number of unique payloads that the RCST may transmit in an RA block is the smallest of the maxima that are dictated by the constraints listed below:

- i) The volume of data backlogged in RCST buffers. The number of unique payloads shall not exceed the backlogged data in RCST buffers considering the timeslot format and waveform of the given RA blocks.
- ii) Constraints dictated by the Lower Layer Service Descriptor given in table 6-76. The number of unique payloads shall not exceed the upperbounds dictated by the Lower Layer Service Descriptor. Lower Layer Service Descriptor may dictate strict mapping between traffic classes and CRDSA channels. The computation of the number of unique payloads shall comply with the mapping between traffic classes and the CRDSA allocation channels.
- iii) Constraints dictated by the stationary or dynamic Random Access Load Control mechanism.

Step-2: Select timeslot locations.

For each unique payload, the RCST shall determine *nofInstances* timeslot locations within the RA block by invoking the *PNGenerate* function to calculate a *locArray*, which is shown below in the form of a pseudocode, with a randomly selected seed (*numRand*). The RCST shall check that the selected timeslot locations can be used by the RCST. If one or more timeslot locations cannot be used by the RCST e.g. due to concurrency conflicts, then the *PNGenerate* function may be invoked iteratively with a new selection of random seed (*numRand*) for each iteration. A conflicting selection of timeslot locations shall be discarded.

```
function locArray = PNGenerate(nofInstances, numRand, nofSlots, srcID_LSB16) {
```

```
// Input arguments:
```

```
/* nofInstances: 4-bit unsigned integer. The number of instances of a unique payload to be transmitted in the RA block. This parameter is conveyed by the NCC in the RA Traffic Method Descriptor. */
```

```
/* numRand: 12-bit unsigned integer pseudo-random number that is generated for each PNGenerate call. */
```

```
/* nofSlots: 24-bit unsigned integer. The number of CRDSA slots in the RA block. This parameter is computed at the RCST by decoding SCT and FCT2 signalling tables and the RA block definition in the RA Traffic Method descriptor. */
```

```
/* srcID_LSB16: 16-bit unsigned integer. The least-significant 16 bits of the source ID. The source ID shall be the RCST MAC address when CRDSA slots are used to send initial logon bursts. For RCSTs that are already logged-on, the source ID shall be the logon ID assigned by the NCC. */
```

// Output argument:

```
/* locArray: Array of 24-bit unsigned integers. It contains nofInstances elements. Each element in locArray, designated locArray[k], is the timeslot location in the RA block that is generated for the  $k_{th}$  instance. */
```

```
const Q = 75;
```

```
const M = 231-1;
```

```
const nofInitStages = 9;
```

```
x = (numRand<<20) | (nofInstances <<16) | srcID_LSB16; // concatenation (see figure 7-5)
```

```
for (k=1; k<=nofInitStages; k++)
```

```
    x = (Q*x) modulo M;
```

```
for (k=1; k<=nofInstances; k++) {
```

```
    x = (Q*x) modulo M;
```

```
    locArray[k] = (x >> 16) modulo nofSlots;
```

```
    }
```

```
}
```

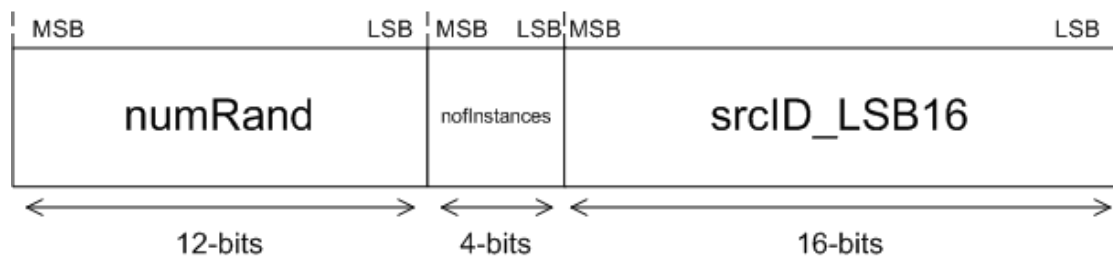

Figure 7-5: Initial value of the variable "x" in PNGenerate function pseudocode

Step-3: Associate timeslot locations and random seeds to unique payloads.

At the end of step-2, the RCST will nominally have generated as many $\{numRand, locArray\}$ pairs as the number of unique payloads to be transmitted in the RA block. The list of $\{numRand, locArray\}$ pairs shall be sorted in the ascending order of the earliest timeslot pointed to in each *locArray*. The unique payloads to be transmitted shall be sorted in the same order as their intended reception order at the receiver. The sorted list of $\{numRand, locArray\}$ pairs shall be in order of sequence with the list of sorted unique payloads. Thus, the instances of the first unique payload shall be transmitted in the timeslot locations of the $\{numRand, locArray\}$ pair with the earliest timeslot location; the instances of the second unique payload shall be transmitted in the timeslot locations of the $\{numRand, locArray\}$ pair with the second earliest timeslot location, and so on. Figure 7-6 illustrates this mapping for an example with 10 slots per RA block, 3 unique payloads, and 3 instances per unique payload.

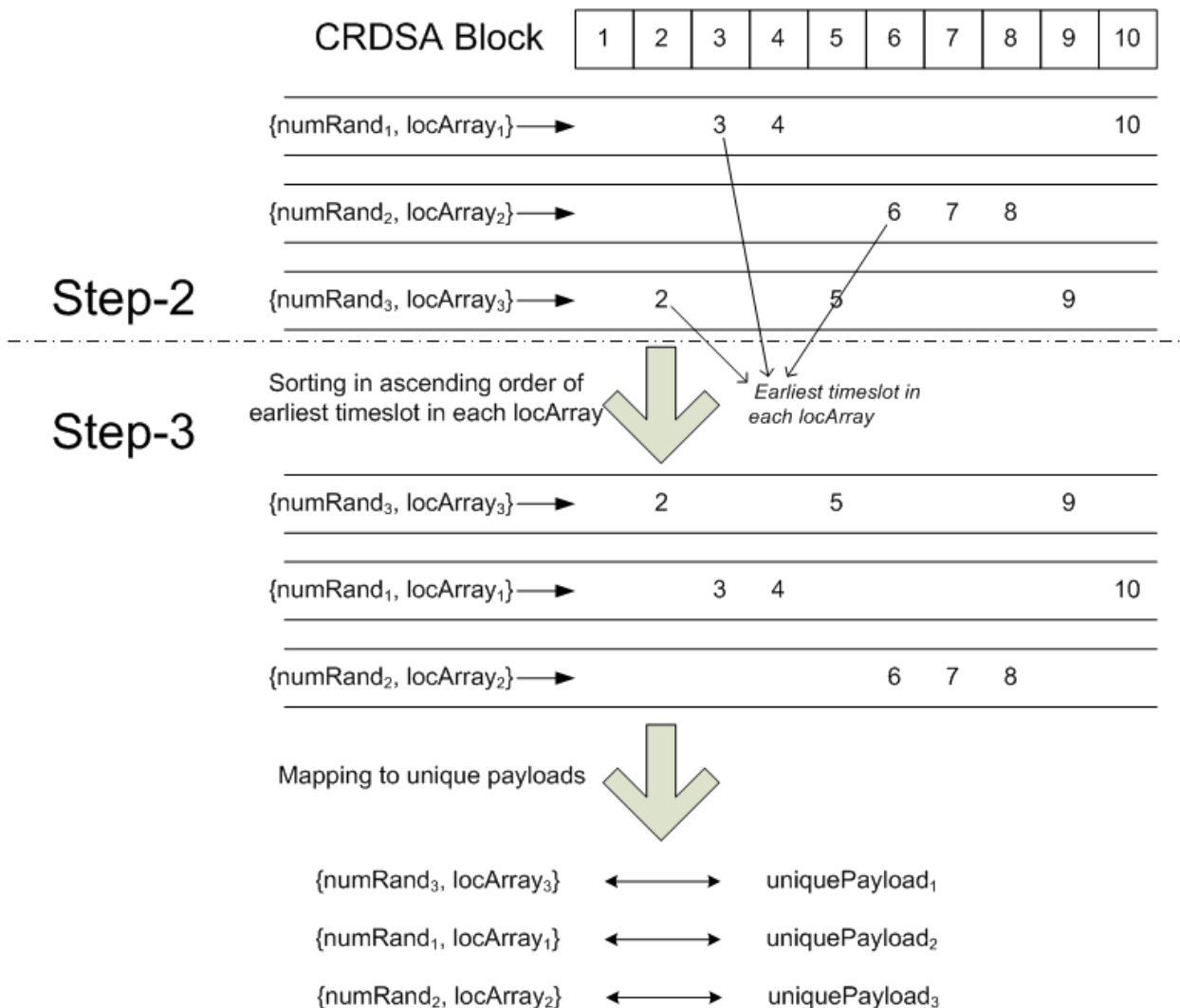

Figure 7-6: Example locArray sorting with nofSlots=10, nofInstances=3 and 3 unique payloads

Step-4: Transmission of instances within the RA block.

The RCST shall replicate each unique payload as necessary to issue *nofInstances* number of instances. The RCST shall include the CRDSA specific payload label with each instance in accordance with table 7-10. The 16-bit CRDSA tag in the payload label shall be the concatenation of the seed (*numRand*) and the total number of instances (*nofInstances*) (as shown in figure 7-7). The seed (*numRand*), submitted in the CRDSA tag for an instance shall be the one associated to the instance's unique payload at the end of step-3.

The RCST shall transmit the instances of a unique payload in the timeslot locations associated to the unique payload at the end of step-3.

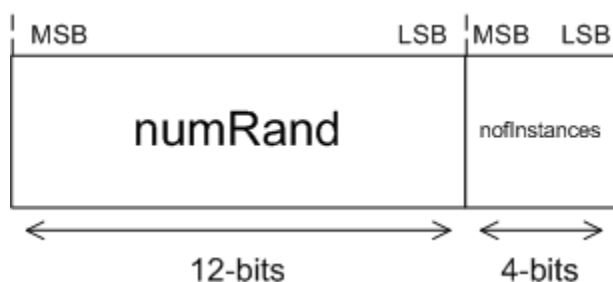

Figure 7-7: CRDSA tag

7.2.5.2.2.2 Variable Replication Ratio CRDSA (informational)

The CRDSA method and replication ratio usage are assumed configured by the NCC per CRDSA channel. If variable replication ratio CRDSA, VR-CRDSA is implemented and used, the possibilities for selecting the replication_ratio are *replication_ratio[k]*, $k=1, \dots, \text{replication_ratio_count}$. For each unique payload, the replication ratio is randomly selected from the allowed set, and a specific replication ratio (*replication_ratio[k]*) is selected by the transmitter with the probability of *replication_ratio_probability[k]*.

Support of VR-CRDSA is implementation dependent.

7.2.5.3 Resources for contention

Timeslots for random access may be assigned via the SCT/FCT2. The TBTP2 may dynamically supply the RCST with random access timeslots.

The RCST shall combine the corresponding timeslot allocations in the SCT/FCT2 with the dynamic allocation of corresponding timeslots in the TBTP2 into one timeslot pool for each of the content types, before selecting timeslots. Timeslots can thus be given either only directly by the SCT/FCT2, only via the TBTP2 or these in combination.

7.2.6 Dedicated access

7.2.6.0 Introduction

The NCC uses the Lower Layer Service Descriptor specified in clause 6.4.17.17 to instruct the RCST of at least a minimum lower layer service that the RCST needs to communicate with the network control system. The NCC may provide the RCST with the complete specification of the complete set of lower layer services that it provides to the RCST, or the NCC may provide the RCST with supplemental information for the lower layer services via higher layer protocols that are out of scope for the present document.

The NCC may provide an RCST with timeslots for dedicated access by the respective RCST.

7.2.6.1 Channels for Dedicated access

7.2.6.1.1 Timeslots Dedicated to an RCST and for Logon Burst

Timeslots can be assigned exclusively to an RCST for logon burst transmission by the SCT/FCT2/BCT in combination with the TBTP2. The RCST shall be capable of utilizing such timeslots.

7.2.6.1.2 Timeslots Dedicated to an RCST and for Control Burst

Timeslots may be assigned exclusively to an RCST for control burst transmission, by the TIM-U and by the TBTP2, in combination with the SCT/FCT2/BCT. This may be a one-time instruction assigning timeslots at regular intervals in a static regular pattern that is granted for the whole period the RCST is logged on. In the logged on state, RCST shall in the logged-on state transmit a control burst in every control type timeslot dedicated to the RCST.

The control timeslot assignment indicated in the logon response TIM-U is to be considered valid for transmission in the situation when the timeslot position can be unambiguously determined by inspecting the FCT2 and the BCT alone, i.e. without inspecting the TBPT2. This implies that, by inspecting the applicable frame from the position holding timeslot #0, no timeslot up to and including the timeslot that is assigned may be configured with *default_tx_type=0*. If *default_tx_type=0* for any of these timeslots, the RCST shall not transmit based on the control assignment provided in TIM-U, for the full duration of the logon session.

7.2.6.1.3 Timeslots Dedicated to an RCST and for Traffic/Control Content

Timeslots may be assigned for dedicated access by an RCST for traffic/control burst access by the SCT/FCT2/BCT in combination with the TBTP2. The RCST shall be capable of utilizing such timeslots for higher layer traffic and for lower layer signalling.

7.2.6.1.4 Timeslots Dedicated to an RCST and for Traffic Content

Timeslots may be assigned for dedicated access by an RCST for traffic burst access by the SCT/FCT2/BCT in combination with the TBTP2. The RCST shall be capable of utilizing such timeslots for higher layer traffic. The NCC may use this content type to block out transmission of lower layer signalling.

7.2.6.1.5 Carrier Dedicated to an RCST and for Traffic/Control Content

A carrier may be assigned for dedicated access by an RCST for traffic/control access by the SCT/FCT2/BCT in combination with TIM-U. The RCST shall be capable of utilizing such assignment if indicating support for assignment of continuous waveforms. A carrier may be assigned for dedicated access by an RCST for traffic/control access by the SCT/FCT2/BCT in combination with the TBTP2. The RCST shall be capable of utilizing such assignment if indicating support for assignment of continuous waveforms.

7.2.6.2 Unsolicited Resources for Dedicated access

The timeslot allocation process may support these unsolicited assignment methods:

- Constant Rate Assignment (CRA).
- Free Capacity Assignment (FCA).

Timeslots can be assigned exclusively to specific RCSTs by using the TBTP2 and the TIM-U.

CRA is considered a highly regular rate capacity which will be provided according to the service agreement when it may be useful to the terminal, without requiring solicitation. The RCST shall not request for resources for the amount of traffic that can be handled within the indicated level of CRA available for traffic. When supported, CRA level indication is provided explicitly per request class in the Lower Layer Service descriptor in TIM-U, by indication of a constantly provided rate of resources.

A small level of unsolicited resources may be provided to each RCST logged on to the network to pull supervision and control signalling from the RCST. An RCST shall transmit a control burst in each control timeslot dedicated to the RCST.

FCA is capacity which may be assigned to RCSTs. The level of assignment that can be expected is not announced to the RCST in advance and the RCST shall tolerate that the level and rate is highly irregular.

The RCST shall exploit the unsolicited resources for traffic volumes that may be present at the time of availability of unsolicited resources, but may also limit the utilization in order to better satisfy specific QoS requirements.

An RCST that indicates support for CC operation shall support unsolicited assignment of a carrier for continuous transmission and assignment of a tx_type to use with that carrier, assigned in TIM-U for persistent mode and in TBTP2 for non-persistent mode.

7.2.6.3 Solicitation for Resources for Dedicated access

7.2.6.3.0 Introduction

The timeslot allocation process in the NCC shall support at least one of these solicited assignment methods:

- Rate Based Dynamic Capacity (RBDC) method.
- Volume Based Dynamic Capacity (VBDC) method.

Each resource request applies to a context constituted by the intersection of the requesting RCST and the associated request class. The RCST shall support requesting by any of these methods, at NCC discretion.

Resources provided through solicitation are dedicated to specific RCSTs for exclusive access by using the TBTP2.

7.2.6.3.1 Volume Based Dynamic Capacity

7.2.6.3.1.0 Introduction

When volume based dynamic capacity is supported, a suitable volume of resources shall be provided in response to explicit volume requests from the RCST to the NCC. The accrued backlog of volume request at the NCC may be reduced by the volume of resources assigned for the request class.

At the NCC, the accrued volume request backlog for any given request class may automatically expire after a period without any update received by a new volume request for the request class, such expiry resulting in the request backlog being set to zero without being honoured. This timeout may be between 1 and 255 superframes. The NCC shall indicate the applied idle timeout in the Lower Layer Service descriptor in TIM-U. The timeout value is common for all request classes. The RCST may use this timeout to infer the status of the accrued request backlog of each request class at the NCC side.

To prevent an excessive backlog of volume request, the NCC may limit the backlog to a maximum. The NCC indicates the enforced maximum to the RCST so that the remaining headroom in the volume request backlog can be inferred.

Volume based request support is indicated per request class in the Lower Layer Service descriptor in TIM-U. When supported, the maximum backlog accepted by the NCC is indicated per request class in the Lower Layer Service descriptor in TIM-U. By default, the RCST shall assume that volume request will not be granted for any request class.

7.2.6.3.1.1 Absolute Volume Based Dynamic Capacity (AVBDC)

AVBDC requests are absolute in the sense that an AVBDC request replaces the previous AVBDC request and any previous VBDC requests of the same request class. The AVBDC shall be used instead of VBDC when the RCST can safely infer that the accrued backlog of volume request at the NCC is zero for the given request class. The AVBDC request shall be used instead of VBDC whenever the traffic backlog has grown from zero for the associated request class since the previous volume request, allowing the NCC to realign its backlog of volume request for the request class.

An AVBDC request shall with the granularity of the signalling system accurately reflect the current backlog of traffic in the RCST for the associated request class.

7.2.6.3.1.2 Incremental Volume Based Dynamic Capacity (VBDC)

VBDC is a volume of resources requested by the RCST. Such requests are cumulative at the NCC. Each new VBDC request adds to a previous AVBDC request and successive VBDC requests for the same request class.

A VBDC request shall within the granularity of the signalling system accurately reflect the volume of traffic affecting the traffic backlog of the RCST for the associated request class, referring to the volume of traffic emerging in the interval since the previous volume request.

7.2.6.3.2 Rate Based Dynamic Capacity (RBDC)

RBDC is a resource assignment rate which is requested dynamically by the RCST. When supported, RBDC requested resources are provided in response to explicit requests from the RCST to the NCC. Such requests are absolute. Each new request overrides previous RBDC requests related to the same request class.

The most recent RBDC request received by the NCC for a given request class may automatically expire after a timeout period. Such expiry may result in the RBDC requested resources not being honoured. The timeout may be between 1 and 255 superframes. The timeout applied for RBDC request shall be indicated by the NCC. The applied RBDC request idle timeout is indicated in the Lower Layer Service descriptor in TIM-U as a common value for all request classes.

RBDC support is indicated per request class in the Lower Layer Service descriptor in TIM-U. When RBDC is supported, the maximum RBDC level allowed is implicitly indicated as the difference between the indicated maximum rate and the indicated constantly provided rate. The NCC shall accept RBDC requests up to the indicated supported level, rounded up to the nearest higher value if the supported level cannot be accurately indicated. The RCST shall not request for a higher RBDC level than this. By default, the RCST shall assume that RBDC request will not be granted for any request class.

7.2.6.3.3 Requests per request class

An RCST shall be capable of requesting for capacity independently per allowed request class. The NCC associates each RCST request class to an `rc_index` value. The RCST shall be explicitly configured to use the same mapping. Such configuration is out of scope for the present document.

An RCST shall be capable of concurrently requesting for resources in at least three request classes.

7.2.6.3.4 Limitation of the Requested Level of Resources

An RCST shall not request for more resources for transmission of frame payload (occupied by Frame PDU and frame CRC) than if the request is granted in full, provides the RCST with more than in average 110 % of the frame payload resources required to forward the associated traffic. This concerns as a minimum regular characteristic traffic patterns associated with the specific request class. This requirement applies per request class for the accrued resources from resources requested, explicitly admitted unsolicited resources (indicated CRA) and resources taken without solicitation (RA), for all capacity categories combined.

Characteristic traffic patterns and requirements to traffic characteristics are assumed associated with the traffic aggregate that maps to a specific request class. The specification of such traffic patterns and the requirements to the traffic characteristics of the different traffic aggregates are out of scope for the present document, but may be considered to encompass at least zero traffic and highly regular traffic for any aggregate. Differentiated mapping of specific traffic aggregates to lower layer services is out of scope for the present document. Configuration of this may be managed as specified in ETSI TS 101 545-3 [i.16].

7.2.6.3.5 Carrier for Continuous Transmission (Option)

The NCC indicates the support of requests in the CC mode configuration. An RCST that supports continuous transmission may request a supporting NCC explicitly for assignment of a whole carrier of a specific frame type and assignment of a specific `tx_type` to use with that carrier. The supporting NCC shall respond to each CC message request signal from the RCST with a CC Control descriptor. If indication is given that carrier request is not supported, the NCC may silently ignore these requests:

- 1) Response to request for carrier may be carrier assignment or rejection.
- 2) Response to release request shall be carrier revocation.
- 3) Response to replace request may be carrier assignment or rejection.

For non-persistent mode, the NCC uses the CC Control Descriptor to indicate to the RCST support of capacity requests for BoD also when being assigned a carrier for continuous transmission, as specified by the Lower Layer Service Descriptor in clause 6.4.17.17. The capacity requests shall then be issued through in-band Control PDUs. The NCC may explicitly indicate that it does not support requesting for capacity during the CC operation.

7.2.7 Burst Time Plan Distribution

The NCC shall broadcast the Burst Time Plan (BTP) to all the affected RCSTs through the SCT/FCT2/BCT, the TIM-U and the Terminal Burst Time Plan messages (TBTP2). The TBTP2 messages are the culmination of the centralized control of the RCST for deciding when and how to transmit, and what to transmit. The TBTP2 `superframe_count` does for control timeslots and traffic timeslots refer to the first superframe with this `superframe_count` that occur later than the time of arrival of the TBTP2.

The latency from the arrival of a TBTP2 message at the RCST until the RCST is capable of transmitting the bursts allowed by the specific TBTP2 message shall not exceed 90 ms for MF-TDMA transmissions. The latency from the arrival of a BCT update at the RCST until the RCST shall be capable of using the altered or new waveforms from the updated BCT as reference at TBTP2 message reception shall not exceed 90 ms for MF-TDMA transmissions. When switching between transmission types of two or more transmission format class to another, the latency is implementation dependent and may even imply a reboot of the RCST. The latency shall however not exceed 2 s for switching to and from the optional continuous carrier transmissions, if this supported. Support of more than a single transmission format class in a superframe sequence is specified in clause 7.5.1.3.

The access method that applies for a timeslot may be permanently assigned by the frame type specification, or the frame type specification may leave it to the TBTP2 to indicate the access method just in time.

Periodic timeslots may be exclusively assigned to an RCST by a recurring assignment with a first superframe, a timeslot position and a repeat interval that equals a number of superframes, by using the Control Assign Descriptor in TIM-U.

The BTP information may be required by a mesh burst receiver in order to identify the source of the burst transmission where this information is not provided with the transmission itself. Such functionality is out of scope for the present document.

The RCST shall by default utilize all the assigned resources to send any compatible pending traffic to the gateway. The RCST may be configurable to differentiate between traffic aggregates in this mapping as it may be capable of mapping certain traffic aggregates to other physical layer connectivity than the NCC/gateway. Such configuration is out of scope for the present document.

7.2.8 Assignment of a Carrier for Continuous Transmission (Option)

The NCC may assign a complete carrier for continuous transmission by the RCST, if the RCST indicates this support in the Logon PDU. This is done by the CC Control Descriptor in the TIM-U for "persistent mode" and in the TBTP2 for "non-persistent mode". The carrier assignment is valid for the allowed duration of the continuous transmission as specified in clause 9.9.2.

7.3 Transmission Bursts

7.3.1 Transmission Burst Content Type

Each transmission burst belongs to a transmission type that is assigned a specific content type. This is determined by the specification of the transmission type in the BCT. The format and syntax of the burst payload is determined by the content type, and also the transmission context, when the format and syntax is context variant.

Four content types are defined:

- 1) logon (non-configurable context variant frame payload format)
- 2) control (non-configurable context variant frame payload format)
- 3) traffic/control (configurable context variant transmission frame payload format)
- 4) traffic (configurable context variant transmission frame payload format)

7.3.2 Burst Waveform

The burst waveform generation shall be applied to the Frame PDU. The generation consists of the following functions, as represented in figure 7-8:

- Energy dispersal.
- Addition of a Cyclic Redundancy Check (CRC).
- Coding and interleaving techniques.
- Unique word and/or known pilot insertion.
- Linear Modulator (LM) or Continuous Phase Modulator (CPM).

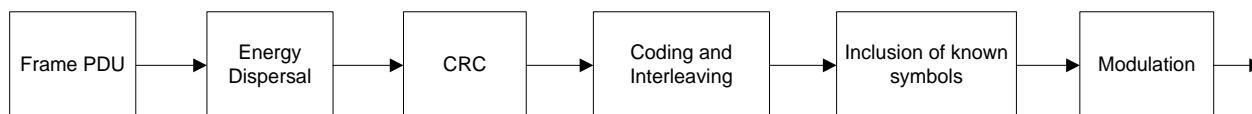

Figure 7-8: DVB-RCS2 burst waveform generation

7.3.3 Energy Dispersal

The MF-TDMA return link data stream is organized in bursts. In order to comply with ITU Radio Regulations [i.29] and to ensure adequate binary transitions, the bit stream in a burst shall be varied by scrambling to reduce the probability of monotonic bit sequences. A PRBS sequence shall be used. The polynomial of the Pseudo Random Binary Sequence (PRBS) shall be as specified by the polynomial expression (7-1).

$$1 + x^{14} + x^{15} \tag{7-1}$$

The data is randomized using the 15 register Linear Feedback Shift Register (LFSR) shown in figure 7-9 to randomize the distribution of ones and zeroes. The randomizer performs modulo-2 addition of the data with the pseudo-random sequence. The initial content of the SR-1 to SR-15 registers is given in table 7-11. The first bit of the pseudo-random sequence is to be added modulo-2 with the first bit of the serial data bit stream, i.e. the first bit after the burst preamble. The randomizer is reset to the initial content before processing a burst payload.

The Frame PDU shall be issued to the energy dispersal scrambler as a bit sequence with content that complies with the following:

- 1) Fixed fields of the data structures shall be issued in the order they are listed, from top to bottom.
- 2) A contiguous sequence of fields as an iteration of a field type shall be issued in the order of iteration.
- 3) Relocatable fields of a flexible data structure may be issued in any order if not explicitly indicated otherwise.
- 4) Reserved bits associated to a field shall be issued before the information bits of the same field.
- 5) Multi-bit fields shall be issued in bit order starting with the bit considered most significant and ending with the bit considered least significant.

Table 7-11: Initial Content of the Randomizer

Shift register	SR1	SR2	SR3	SR4	SR5	SR6	SR7	SR8	SR9	SR10	SR11	SR12	SR13	SR14	SR15
Bit value	1	0	0	1	0	1	0	1	0	0	0	0	0	0	0

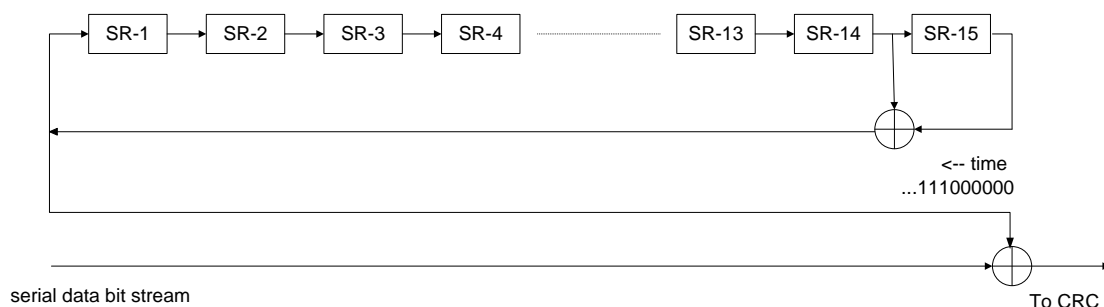

Figure 7-9: PRBS Randomizer

7.3.4 Payload CRC

The alternatives used for the frame CRC shall be as specified in table 7-12.

The frame CRC shall be calculated for the bit sequence output from PRBS Randomizer.

Table 7-12: Frame CRC type for Different Contexts and Payload Types

Transmission context	Logon Burst Payload	Control Burst Payload	Payload for Traffic
Transparent star, any access method	CRC16	CRC16	CRC32

The CRC16 shall be calculated over the Frame PDU (exclusive of the CRC itself). The CRC16 polynomial is $x^{16} + x^{15} + x^2 + 1$. The CRC is the remainder of the division of the burst payload by the polynomial.

The CRC16 shall be equivalent to that computed by a circuit as shown in figure 7-10. The shift register cells shall be initialized to 0 before the start of the computation. First, the switches are in position "A", and the data word is shifted in (and simultaneously transmitted). After the last Frame PDU bit, the switches are moved to position "B", and the contents of the shift register are transmitted, starting with the bit at the end of the register. This is the CRC16.

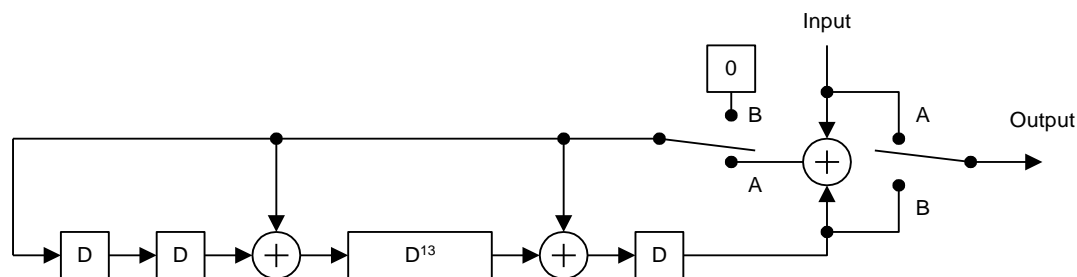

Figure 7-10: CRC16 calculation

The CRC32 shall be calculated over the Frame PDU (exclusive of the CRC32 itself). The RCST shall use the CRC32 polynomial and the calculation method specified in annex B of ISO/IEC 13818-1 [6]:

$$x^{32} + x^{26} + x^{23} + x^{22} + x^{16} + x^{12} + x^{11} + x^{10} + x^8 + x^7 + x^5 + x^4 + x^2 + x + 1$$

The RCST initializes the CRC32 accumulator register to the value 0xFFFF FFFF. It then accumulates a value for the CRC32 that is computed over all bits of the Frame PDU (not the CRC itself).

7.3.5 Coding and Interleaving

7.3.5.0 Introduction

Two transmitter configurations are specified: one using Turbo coding and linear modulation (TC-LM) and one using Convolutional Coding and Continuous Phase Modulation (CC-CPM).

7.3.5.1 The Turbo FEC Encoder for Linear Modulation

7.3.5.1.0 Introduction

The turbo encoder shown in figure 7-11 is used for FEC encoding for linear modulation. It uses a double binary Circular Recursive Systematic Convolutional (CRSC) code. The MSB bit of the first byte after the burst preamble is assigned to A, the next bit to B and so on for the remaining of the burst content.

The encoder is fed by blocks of K bits or N couples ($K = 2 \cdot N$ bits). N is a multiple of 4 (K is a multiple of 8).

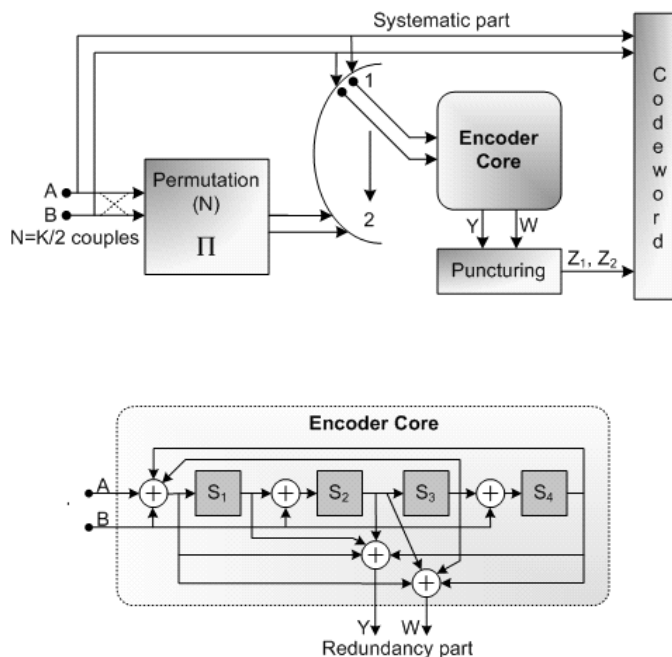

Figure 7-11: Encoder block diagram (turbo code)

The Feedback branch is given by the polynomial $1 + x^3 + x^4$ in symbolic notation (23 in octal). The first parity bits Y are given by the polynomial $1 + x^1 + x^2 + x^4$ (35 in octal) and the second parity bits W by the polynomial $1 + x^2 + x^3 + x^4$ (27 in octal).

The input A bit is connected to tap 1 of the shift register. The input B bit is connected to the taps 1, S_1 and S_3 .

First, the encoder (after initialization by the circulation state C_1) is fed by the sequence in the natural order (switch in position 1) from incrementing position $i=0, \dots, N-1$. This first encoding output sequence after puncturing is called Z_1 .

Then the encoder (after initialization by the circulation state C_2) is fed by the interleaved order sequence (switch in position 2) with incremental address $j=0, \dots, N-1$. This second encoding output sequence after puncturing is called Z_2 . The interleaver function $\Pi(j)$ gives the natural order index i reference for the considered couple.

The encoder core is run four times, first to find the initial circulation states C_1 and C_2 and then to generate the redundancy couples (Y,W). Initialization by the circulation states C_1 and C_2 is explained in clause 7.3.5.1.2.

7.3.5.1.1 Turbo Code Permutation

The permutation is done in two parts. One part is permutation inside the bit couple and the second part is permutation between couples. A_0 is the first information bit that enters the encoder, B_0 the second information bit of the first couple with input order index $i=0$.

The permutation is controlled by the permutation control parameters set P, Q0, Q1, Q2 and Q3.

$$\text{if } j \bmod 2 = 0, \text{ interchange } A_j \text{ and } B_j, \text{ i.e. the internal order is changed to } (B_j, A_j) \quad (7-2)$$

$$\text{if } j \bmod 4 = 0, \text{ then } Q(j) = 0$$

$$\text{if } j \bmod 4 = 1, \text{ then } Q(j) = 4 * Q_1$$

$$\text{if } j \bmod 4 = 2, \text{ then } Q(j) = 4 * Q_0 * P + 4 * Q_2 \quad (7-3)$$

$$\text{if } j \bmod 4 = 3, \text{ then } Q(j) = 4 * Q_0 * P + 4 * Q_3$$

The permutation of bit couples is done by selecting bit couples from the natural order input sequence given by inserting (7-3) in (7-4).

$$i = \Pi(j) = (P * j + Q(j) + 3) \text{ modulo } N \quad (7-4)$$

such that the j-th output couple (A_j, B_j) or (B_j, A_j) as determined by (7-2) or (7-5) is copied from the i-th input couple (A_i, B_i) . Permutation parameters are specified explicitly for each waveform.

7.3.5.1.2 Circulation of Initial State

The state of the turbo encoder is denoted S with:

$$S = 8 * S_1 + 4 * S_2 + 2 * S_3 + S_4 \text{ with } 0 \leq S \leq 15 \quad (7-5)$$

See figure 7-11.

The circulation states C_1 and C_2 are determined by the following operations:

- The encoder is initialized by the state $S = 0$.
- The sequence is encoded in the natural order for the determination of C_1 and in the interleaved order for the determination of C_2 .
- The last state of the encoder (i.e. the state of the encoder after all the N couples have been encoded) and the $N \text{ mod } 15$ determine the initial circulation state (C_1 or C_2) according to table 7-13.

Table 7-13: Initial circulation state as a function of last encoder state S and N mod 15

N mod 15	Last Encoder State															
	0	1	2	3	4	5	6	7	8	9	10	11	12	13	14	15
1	0	14	3	13	7	9	4	10	15	1	12	2	8	6	11	5
2	0	11	13	6	10	1	7	12	5	14	8	3	15	4	2	9
3	0	8	9	1	2	10	11	3	4	12	13	5	6	14	15	7
4	0	3	4	7	8	11	12	15	1	2	5	6	9	10	13	14
5	0	12	5	9	11	7	14	2	6	10	3	15	13	1	8	4
6	0	4	12	8	9	13	5	1	2	6	14	10	11	15	7	3
7	0	6	10	12	5	3	15	9	11	13	1	7	14	8	4	2
8	0	7	8	15	1	6	9	14	3	4	11	12	2	5	10	13
9	0	5	14	11	13	8	3	6	10	15	4	1	7	2	9	12
10	0	13	7	10	15	2	8	5	14	3	9	4	1	12	6	11
11	0	2	6	4	12	14	10	8	9	11	15	13	5	7	3	1
12	0	9	11	2	6	15	13	4	12	5	7	14	10	3	1	8
13	0	10	15	5	14	4	1	11	13	7	2	8	3	9	12	6
14	0	15	1	14	3	12	2	13	7	8	6	9	4	11	5	10

7.3.5.1.3 Rates and Puncturing Map

Each burst has a FEC code rate determined by a specific puncturing period and puncturing pattern, for each of the bit streams of the redundancy bits Y and W.

The different rates are achieved through generating parity bits by selectively deleting the redundancy bits (puncturing). The chosen puncturing patterns (see table A-3) are applied. These patterns are identical for both the natural order and the interleaved order encoder outputs. They are also independent of the modulation (depends only on the code rate).

The output sequences of the puncturing are named Z1 and Z2, respectively for the natural-order encoding and the interleaved-order encoding. They each consist of the Y parity bits that remain after puncturing, followed by the W parity bits that remain after puncturing.

7.3.5.2 Convolutional Encoder for CPM

7.3.5.2.0 Introduction

The functional blocks in the CC-CPM transmitter include the convolutional coder, bit interleaving, and bit-to-symbol mapping, as shown in figure 7-12. Burst type sets shall be configurable.

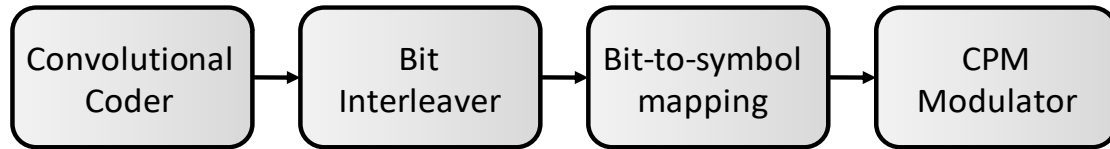

Figure 7-12: Block diagram depicting the CC-CPM transmitter components, including convolutional coder, bit interleaver, symbol mapping and the CPM modulator

The functional blocks in the Convolutional Coded CPM (CC-CPM) transmitter include the convolutional coder, bit interleaver, bit-to-symbol mapping and the CPM modulator, as shown in figure 7-12. Burst type sets shall be configurable.

The configurable elements for the CC-CPM transmitter are:

- Modulation parameters:
 - Modulation index h which is a rational number and can be expressed as m_h/p_h , where m_h and p_h are integers such that $1 \leq m_h, p_h \leq 7$.
 - Pulse shape:
 - Specified by the parameter α_{RC} , where $0 < \alpha_{RC} \leq 1$, or α_{RC} .
 - Pre-computed and tabularized.
- FEC constraint length, and code rate:
 - Constraint length K and the corresponding code generator polynomials.
 - Code rate expressed as k/n .
- Bit-interleaver permutations:
 - derived algebraically by specifying select parameters; or
 - pre-computed and tabularized.
- Burst construction:
 - Number of UW segments.
 - For each UW segment, position, length and contents.

The non-configurable parameters for the CC-CPM transmitter are:

- Alphabet size, $M = 4$.
- Pulse width, $L = 2$.
- FEC scheme, convolutional coding and associated puncturing pattern P as defined by the choice of the code rate and constraint length.

7.3.5.2.1 The FEC Encoder for CPM

Binary, non-systematic, non-recursive convolutional codes are used as the FEC for CPM. The constraint length K is either 3 or 4. The generator polynomials for the rate 1/2 constraint length 3 code are $G_{NS1} = 1 + x^2$ (5 in octal), and $G_{NS2} = 1 + x + x^2$ (7 in octal). The rate 1/2 constraint length 3 code is shown in figure 7-13.

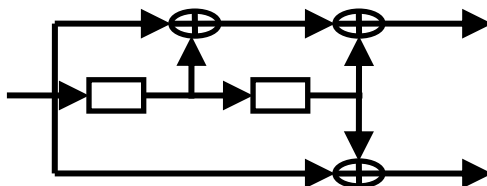

Figure 7-13: Convolutional code with constraint length 3

The generator polynomials for the rate 1/2 constraint length 4 code are $G_{NS1} = 1 + x + x^3$ (15 in octal), and $G_{NS2} = 1 + x + x^2 + x^3$ (17 in octal). The rate 1/2 constraint length 4 convolutional code is shown in figure 7-14.

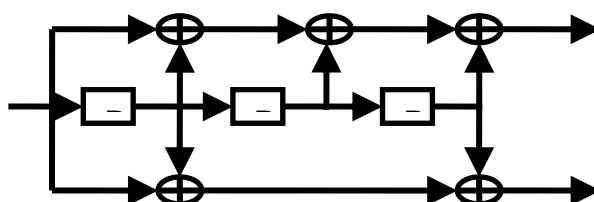

Figure 7-14: Convolutional Code with constraint length 4

Code rates $> 1/2$ are obtained by puncturing the rate 1/2 code. The puncturing patterns are given in table 7-14.

Table 7-14: Essential Code rates and puncturing patterns

Code rate	Puncturing pattern for constraint length 3 code	Puncturing pattern for constraint length 4 code
1/2	11	11
2/3	11 01	11 10
3/4	11 01 10	11 10 01
4/5	11 01 10 10	11 01 10 10
6/7	11 01 10 10 10 10	11 01 01 01 10 10

The puncturing pattern is periodically applied to the serialized bit stream at the rate 1/2 convolutional encoder's output. When the puncturing pattern is 1 the corresponding encoder output is transmitted and when it is 0, the encoder output is deleted. As an example, figure 7-15 illustrates the puncturing process for the rate 6/7 constraint length 4 code, when the information bit length is 1 504 bits. The counter for the puncturing pattern is reset prior to encoding the next information burst, i.e. when the bit index is 1, the corresponding puncturing pattern is 11.

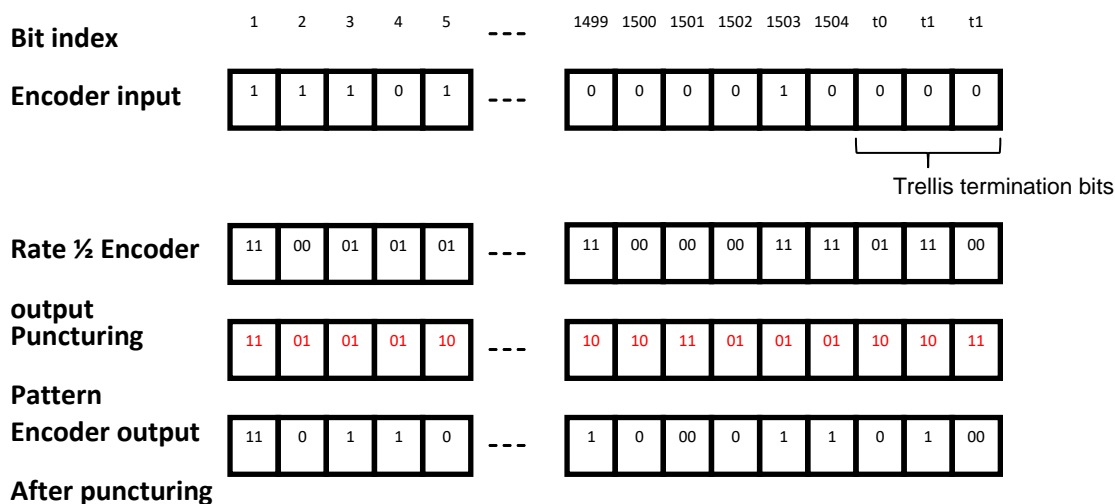

Figure 7-15: Puncturing process for rate 6/7, K=4 convolutional code

7.3.5.2.2 Trellis Termination

After the encoding of information bits is complete, the convolutional encoder states are flushed to all zero values by feeding tail bits $t_0 = 0$, $t_1 = 0$ for the constraint length 3 code, and $t_0 = 0$, $t_1 = 0$, $t_2 = 0$ for the constraint length 4 code. As shown in figure 7-15 the encoded tail bits are punctured by the same puncturing pattern applied to the encoded information bits and are appended at the end of the encoded information bits.

7.3.5.2.3 The Bit-interleaver for CPM

The interleaver specifies the permutation of the bits in a codeword. More specifically, the interleaver is the set of permutation indices $\pi = [\pi(0), \pi(1), \dots, \pi(N-1)]$, such that the bit sequence at the output of the convolutional encoder $b' = [b'_0, b'_1, \dots, b'_{N-1}] \in \{0,1\}^N$ is mapped to $b = [b_0, b_1, \dots, b_{N-1}] = [b'_{\pi(0)}, b'_{\pi(1)}, \dots, b'_{\pi(N-1)}] \in \{0,1\}^N$ at the output of the interleaver. The interleaver permutations are generated using the following set of equations:

- 1) Begin with an initial interleaver permutation vector $\pi_{initial} = [0, 1, 2, \dots, N-1]$.
- 2) Partition $\pi_{initial}$ into two distinct groups, $\pi_{initial}^1 = [0, 1, 2, \dots, N_1-1]$, and $\pi_{initial}^2 = [N_1, N_{1+1}, \dots, N-1]$.

$\pi_{initial}^1$ is further divided in $N_1/12$ sub-groups. On each of these $N_1/12$ sub-groups the sub-permutation mask $\pi_{12}^1 = [9, 11, 8, 6, 10, 2, 4, 0, 7, 5, 1, 3]$ is applied.

The resulting intermediate interleaver permutation is given by:

$$\pi_{intermediate1}(i) = \pi_{initial}^1((j-1) \times 12 + \pi_{12}^1(R_{12}[i])), i = 0, 1, \dots, N_1-1$$

where the index i falls within the sub-group j , such that $j \in \{1, 2, \dots, N_1/12\}$ and $R_N[\cdot]$ represents the *modulo-N* operator.

$\pi_{initial}^2$ is partitioned into $(N-N_1)/12$ sub-groups. On each of these sub-groups, the sub-permutation mask $\pi_{12}^2 = [8, 11, 6, 4, 0, 7, 3, 10, 1, 5, 9, 2]$ is applied.

The resulting intermediate interleaver permutation is given by:

$$\pi_{intermediate1}(i) = \pi_{initial}^2((j-1) \times 12 + \pi_{12}^2(R_{12}[i])), i = N_1, 1, \dots, N-1$$

where the index i falls within the sub-group j , such that $j \in \{1, 2, \dots, (N-N_1)/12\}$.

- 3) Define an intermediate permutation $\pi_{intermediate2}(i) = \pi_{intermediate1}(R_N[s + p \times i]), i = 0, 1, \dots, N-1$, where s and p are integers, and p is co-prime with N , such that $p < N$ and $s < 30$.
- 4) Define $\pi_{intermediate3}(i) = \pi_{intermediate2}(\pi_{intermediate1}(i)), i = 0, 1, \dots, N-1$.

- 5) Partition $\pi_{intermediate3}$ into four distinct sub-groups $\pi_{intermediate3}^1, \pi_{intermediate3}^2, \pi_{intermediate3}^3, \pi_{intermediate3}^4$ having K_1, K_2, K_3 and K_4 elements respectively, such that $K_1 + K_2 + K_3 + K_4 = N$.

$\pi_{intermediate3}^1$ is further divided into $K_1/12$ sub-groups. On each of these sub-groups the sub-permutation mask $\pi_{12}^3 = [4\ 10\ 5\ 8\ 3\ 6\ 9\ 11\ 1\ 7\ 0\ 2]$ is applied, such that:

$$\pi_{intermediate4}(i) = \pi_{intermediate3}^1((j-1) \times 12 + \pi_{12}^3(R_{12}[i])), i = 0, 1, \dots, K_1 - 1$$

where the index i falls within the sub-group j , such that $j \in \{1, 2, \dots, K_1/12\}$.

$\pi_{intermediate3}^2$ is divided into $K_2/12$ sub-groups, each having 12 elements. On each of these sub-groups the sub-permutation mask $\pi_{12}^4 = [5\ 8\ 10\ 2\ 6\ 4\ 7\ 1\ 3\ 9\ 11\ 0]$ is applied such that:

$$\pi_{intermediate4}(i) = \pi_{intermediate3}^2((j-1) \times 12 + \pi_{12}^4(R_{12}[i])), i = K_1, 1, \dots, (K_1 + K_2) - 1$$

where the index i falls within the sub-group j , such that $j \in \{1, 2, \dots, K_2/12\}$.

$\pi_{intermediate3}^3$ is further divided into $K_3/12$ sub-groups. On each of these sub-groups the sub-permutation mask $\pi_{12}^5 = [10\ 0\ 9\ 1\ 11\ 7\ 3\ 5\ 8\ 6\ 2\ 4]$ is applied such that:

$$\pi_{intermediate4}(i) = \pi_{intermediate3}^3((j-1) \times 12 + \pi_{12}^5(R_{12}[i])), i = (K_1 + K_2), 1, \dots, (K_1 + K_2 + K_3) - 1$$

where the index i falls within the sub-group j , such that $j \in \{1, 2, \dots, K_3/12\}$.

$\pi_{intermediate3}^4$ is divided into $K_4/12$ sub-groups. On each of these sub-groups the sub-permutation mask $\pi_{12}^6 = [9\ 7\ 2\ 4\ 10\ 8\ 3\ 6\ 11\ 1\ 5\ 0]$ is applied such that:

$$\pi_{intermediate4}(i) = \pi_{intermediate3}^4((j-1) \times 12 + \pi_{12}^6(R_{12}[i])), i = (K_1 + K_2 + K_3), 1, \dots, N - 1$$

where the index i falls within the sub-group j , such that $j \in \{1, 2, \dots, K_4/12\}$.

- 6) The final interleaver permutation is given by $\pi_{intermediate3}(\pi_{intermediate4}(i)), i = 0, 1, \dots, N - 1$.

It can be observed from the above equations that for a given N , the interleaver may be implemented algebraically, by specifying the sub-permutation masks and the six parameters s, p, N_1, K_1, K_2 and K_3 .

Table 7-15 lists the above six parameters at different values of N .

Table 7-15: Parameters for the Algebraic Representation of Interleaver

N	s	p	N ₁	K ₁	K ₂	K ₃
336	28	67	168	84	84	84
468	15	229	252	144	132	120
504	2	19	252	144	132	120
600	8	491	480	168	144	144
804	8	241	480	240	216	192
912	4	373	456	240	228	228
1 200	1	227	1 080	360	336	384
1 284	10	251	744	360	336	312
1 536	12	107	768	408	384	384
1 752	6	433	1 716	1 200	240	192
1 884	22	47	960	504	480	468
2 052	2	317	1 200	552	528	504
2 256	8	653	1 200	576	576	576
3 012	5	241	1 440	1 152	576	576

The resulting interleaver permutations for the different values of N shown in table 7-15 are provided in annex B.

Instead of computing the interleaver permutations "on-the-fly", the permutations may be precomputed using the equations, and implemented as a lookup tables.

7.3.6 Inclusion of Known Symbols

7.3.6.0 Introduction

The transmission bursts are constructed by combining the payload symbols with symbols known to the receiver in advance, including a unique word. The burst construction rules differ for a TC-LM transmitter and a CC-CPM transmitter.

7.3.6.1 Burst Construction for TC-LM and SS-TC-LM

The generic burst construction for linear modulation is shown from start to end in figure 7-16. The green sections illustrate as an example user payload sections of a burst. One or more of these sections are present in every burst. When direct-sequence spreading is employed, this user payload is obtained from the sequence of symbol values by repetition of the representation of each symbol a number of times equal to the spreading factor. The other components are section types with predetermined content known as preamble (*pre*), pilot block (*p*) and postamble (*post*). A preamble is typically present in every burst. The repetitions of, the size of, the interval of and the content of the pilot block are configurable. The pilot blocks are evenly distributed with evenly sized payload sections in between. A postamble may be present.

The sequences of processing for spread and un-spread bursts respectively are illustrated in figure 7-17.



Figure 7-16: TC-LM burst structure

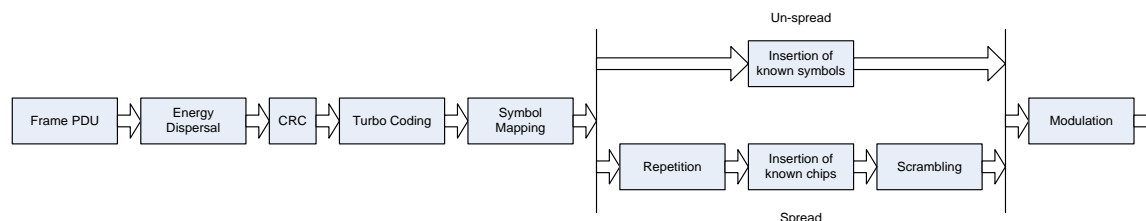

Figure 7-17: Processing for spread and un-spread LM bursts

There is support for configuration of the burst construction together with the waveform configuration. Reference burst constructions can be found as part of the reference waveform specifications in annex A.

The following TC-LM burst construction parameters may be signalled in the Forward Link as defined in clauses 6.4.6.1, 6.4.6.4 and 9.9.5.1:

- Pre-amble pattern and length.
- Post-amble pattern and length.
- Number of, size of, interval of and content of pilot blocks.
- Spreading factor.

The rules for positioning of pilots between sections of payload symbols/chips as guided by the pilot block length, pilot period and pilot sum is specified in clauses 6.4.6.1 and 6.4.6.4 for un-spread and spread bursts, respectively. The following rules apply for determining the burst construction from various pilot configurations:

- If the pilot sum is not an integer multiple of the `pilot_block_length`, a remainder less than the `pilot_block_length` shall unconditionally be ignored; no pilot block shall have a length other than `pilot_block_length`.
- Pilot blocks up to the maximum allowed by the `pilot_sum` shall be inserted following the specified placement pattern as long as there is a sufficient number of remaining payload symbols/chips left to insert between consecutive pilot blocks to sustain the `pilot_period`. There may be inserted zero or more payload symbols after the last pilot block.

- Further pilot blocks shall not be inserted when there is not a sufficient number of remaining payload symbols to insert between pilot blocks to sustain the `pilot_period`.

Some TC-LM reference bursts, including both spread and un-spread, are defined based on this framework, in tables A-1 and A-2. These shall be preloaded in the RCST and may be used simply by reference as specified in clauses 6.4.6.1 and 6.4.6.4.

7.3.6.2 Burst Construction for CC-CPM

The generic CC-CPM burst construction is shown from start to end in figure 7-18. The RCST shall support the insertion of a unique word in each CC-CPM burst to support frequency and timing recovery in the receiver, and decoder initialization. The total length of this unique word shall be less than or equal to 256 unique word symbols. The unique word is divided in `nbr_uw_segments` segments of specific length that are located in specific positions in the burst. The payload data preceding an UW segment shall be terminated properly according to the trellis termination procedure described in clause 7.3.7.2.3.

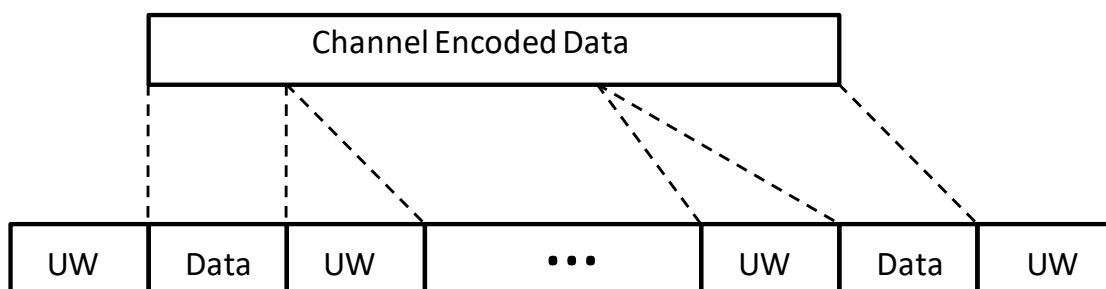

Figure 7-18: CC-CPM burst structure

The following CC-CPM burst construction parameters may be signalled in the Forward Link as defined in clauses 6.4.6.2 and 9.9.5.2.

Some CC-CPM reference bursts are defined based on this framework, in annex A, table A-3. These shall be precoded in the RCST and may be used simply by reference as specified in clause 6.4.6.2.

7.3.7 Modulation

7.3.7.0 Introduction

Two modulation schemes are mandated supported by the RCST, Linear Modulation for the Turbo Coded (TC-LM) Frame PDU and Continuous Phase Modulation for the Convolutionally Coded (CC-CPM) Frame PDU.

7.3.7.1 Linear Modulation of Burst

7.3.7.1.0 Introduction

The transmission burst is constituted by three sections of symbols, the preamble section, the payload section and the postamble section. The payload section may in addition to the payload symbols contain pilot symbols at regular intervals. The symbols are encoded as specified for each section.

For the purpose of this clause and its sub-clauses, the term "symbol" shall be understood to include "chip" when direct-sequence spreading is employed.

7.3.7.1.1 Baseband Shape and Group Delay

Prior to modulation, the I and Q signals (mathematically represented by a succession of Dirac delta functions, multiplied by the amplitudes I and Q, spaced by the symbol duration $TS = 1/RS$) shall be square root raised cosine filtered. The roll-off factor shall be 20 %. The baseband square root raised cosine filter shall have a theoretical function defined by the following expression.

$$\begin{aligned}
 H(f) &= 1 && \text{for } |f| < f_N(1-\alpha) \\
 H(f) &= \sqrt{\frac{1}{2} + \frac{1}{2} \sin \frac{\pi(f_N - |f|)}{2\alpha f_N}} && \text{for } f_N(1-\alpha) \leq |f| \leq f_N(1+\alpha) \\
 H(f) &= 0 && \text{for } |f| > f_N(1+\alpha)
 \end{aligned} \tag{7-6}$$

where $f_N = \frac{1}{2T_s} = \frac{R_s}{2}$ is the Nyquist frequency and α is the roll-off factor.

At the RCST antenna output (using a large output back-off), the group delay variation shall be in accordance with the mask given in ETSI EN 302 307-1 [2] for every configuration supported by the terminal.

7.3.7.1.2 Preamble and Post-amble Symbols

The preamble and the postamble are provided as parts of an UW sequence specified for each burst construction. Dimensions and content of preamble and postamble are specified according to the syntax in clause 6.4.6.1, and is provided in annex A for the reference burst constructions, and may be provided by the NCC signalled as specified in clause 6.4.6.1. The m bits defining each preamble symbol and postamble symbol maps to the constellation the same way as payload symbols, specified in clause 7.3.7.1.4.

7.3.7.1.3 Pilot Block Symbols

Dimensions and content for of the pilot block are specified according to the syntax in clause 6.4.6.1, and is provided in annex A for the reference burst constructions, and may be provided by the NCC signalled as specified in clause 6.4.6.1. The m bits defining each pilot block symbol maps to the constellation the same way as payload symbols, specified in clause 7.3.7.1.4.

7.3.7.1.4 Payload Symbols

7.3.7.1.4.0 Introduction

The FEC encoded sequence shall be mapped to payload symbols as specified in this clause. The payload modulation format is as given by the burst specification. There are four TC-LM modulation formats, $\pi/2$ -BPSK, QPSK, 8PSK and 16QAM. Each modulation format has a specific mapping as specified in this clause.

In the following description, the input of the encoder is grouped into couples (A,B) and the n 'th output couple of the turbo encoder is given by the couple ($Z_{1,n}$, $Z_{2,n}$).

If the number of bits from the output of the encoder is less than a multiple of m , the required minimum number of zeros shall be appended to the tail of the sequence to make it constitute a multiple of m . The modulation format determines m , with $m=1$ for $\pi/2$ -BPSK, $m=2$ for QPSK, $m=3$ for 8PSK and $m=4$ for 16QAM.

7.3.7.1.4.1 Pi/2-BPSK

In the case of $\pi/2$ -BPSK modulation, all couples of systematic bits (A,B) are transmitted first, followed by all couples of systematic parity bits (Z_1, Z_2) that result after puncturing.

The format is given in table 7-16. The value of u_0 is first BPSK mapped with +1 representing a '0' encoder output bit and -1 representing a '1' encoder output bit. All symbols in the frame are further mapped to $\pi/2$ -BPSK modulation. This mapping is done by the outer phase rotation:

$$s(n) = u(n) \times e^{(j\pi n/2 + j\pi/4)}$$

Where $u(n)$ denotes BPSK symbol number n in the burst, and the resulting $s(n)$ symbol is placed in one of the four possible s_k positions visualized in figure 7-19. The integer value n to apply for the very first symbol in the burst is arbitrary. The additional $\pi/4$ term in the phase rotation equation is a convenience factor, in order to place the symbols as for QPSK modulation.

Table 7-16: Bit-to-symbol mapping for pi/2-BPSK modulation

Symbol index	u_0
0	A_0
1	B_0
2	A_1
3	B_1
...	
N-2	$A_{N/2-1}$
N-1	$B_{N/2-1}$
N	$Z_{1,0}$
N+1	$Z_{2,0}$
N+2	$Z_{1,1}$
N+3	$Z_{2,1}$
...	
N+M-2	$Z_{1,M/2-1}$
N+M-1	$Z_{2,M/2-1}$

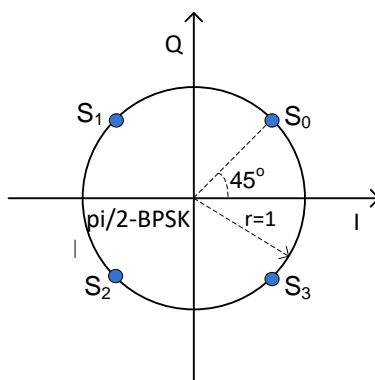

Figure 7-19: pi/2-BPSK constellation

7.3.7.1.4.2 QPSK

In the case of the modulation QPSK, all couples of systematic bits (A,B) are transmitted first, followed by all couples of systematic parity bits (Z_1, Z_2) that result after puncturing.

The format is given by the table 7-17. The value of u_0 and u_1 are mapped in the IQ-diagram as shown in figure 7-20.

Table 7-17: Bit to symbol pattern for QPSK modulation

Symbol index	u_0	u_1
0	A_0	B_0
1	A_1	B_1
...		
N-1	A_{N-1}	B_{N-1}
N	$Z_{1,0}$	$Z_{2,0}$
N+1	$Z_{1,1}$	$Z_{2,1}$
...		
N+M	$Z_{1,M}$	$Z_{2,M}$

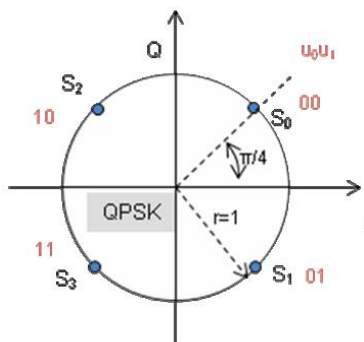

Figure 7-20: QPSK constellation

7.3.7.1.4.3 8PSK

The parity bits are always assigned to the bit u_0 (u_0 and u_1 are most protected by the constellation than u_2). The systematic bits A and B are assigned respectively to u_1 and u_2 . The bits are assigned to symbols in the natural encoder output order.

The ordering of the A and B bits are following the puncturing pattern (given by the configured puncturing map). Once every parity bit is filled into symbols, the symbol bits u_0 , u_1 and u_2 with the reminder systematic bits is fed as described in table 7-18 and in table 7-19. The symbol mapping for 8PSK is specified for code rates $2/3$ and higher.

The constellation is as shown in figure 7-21. When all parity and systematic bits are used, the bit symbols are fed with null values.

Table 7-18: Bit to symbol pattern for 8-PSK modulation and rate $2/3$

Symbol index	u_0	u_1	u_2
0	$Z_{1,0}$	A_0	B_0
1	$Z_{2,0}$	A_1	B_1
2	$Z_{1,1}$	A_2	B_2
3	$Z_{2,1}$	A_3	B_3
...			
$2N-2$	$Z_{1,N-1}$	A_{2N-2}	B_{2N-2}
$2N-1$	$Z_{2,N-1}$	A_{2N-1}	B_{2N-1}

Table 7-19: Bit to symbol pattern for 8-PSK modulation and rate $3/4$ and $5/6$

Symbol index	u_0	u_1	u_2
0	$Z_{1,0}$	A_0	B_0
1	$Z_{2,0}$	A_1	B_1
2	$Z_{1,1}$	A_2	B_2
3	$Z_{2,1}$	A_3	B_3
...			
$2k$	$Z_{1,k}$	A_k	B_k
$2k+1$	$Z_{2,k}$	A_{k+1}	B_{k+1}
When all $2M$ parity bits are given:			
$2M$	A_M	B_M	A_{M+1}
$2M+1$	B_{M+1}	A_{M+2}	B_{M+2}
...			

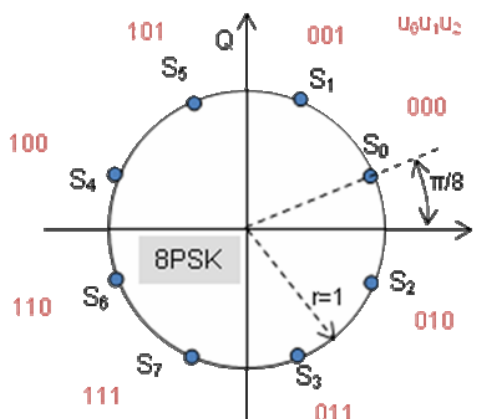

Figure 7-21: 8-PSK constellation

7.3.7.1.4.4 16QAM

A 16-QAM constellation can be decomposed into two independent 4-Pulse Amplitude Modulation constellations, respectively on I and Q axis (denoted I-PAM and Q-PAM).

The symbol mapping for 16QAM is specified for code rates $3/4$ and higher.

The parity bits are assigned to the most protected bit position u_1 -bit of the Q-PAM.

For rates $> 3/4$, the number of symbols is higher than the number of Z-bits in the frame. Once all Z-bits have been assigned to the first $2M$ symbols, the remaining A and B bits are used to fill the remaining symbols, in the order they are coming out from the encoder.

If the pattern is incomplete, the I-PAM is fed by 0. If the last 16QAM symbol resulting from this mapping is only required for transmission of a solitary trailing parity bit, this 16QAM symbol is omitted from the waveform.

The format is given by table 7-20. Then the values u_0 and u_1 are mapped in the IQ-diagram as described in table 7-21.

Table 7-20: Bit to symbol mapping for 16-QAM modulation

Symbol index	Q-PAM		I-PAM	
	u_{Q1}	u_{Q0}	u_{I1}	u_{I0}
0	$Z_{1,0}$	A_0	B_0	A_1
1	$Z_{2,0}$	B_1	A_2	B_2
2	$Z_{1,1}$	A_3	B_3	A_4
3	$Z_{2,1}$	B_4	A_5	B_5
...				
$2k$	$Z_{1,k}$	A_{3k}	B_{3k}	A_{3k+1}
$2k+1$	$Z_{2,k}$	B_{3k+1}	A_{3k+2}	B_{3k+2}
When all $(2M)$ parity bits are given and code rate $> 3/4$				
$2M$	A_{3M}	B_{3M}	A_{3M+1}	B_{3M+1}
...				
$2M+k$	A_{3M+2k}	B_{3M+2k}	$A_{3M+2k+1}$	$B_{3M+2k+1}$
...				

Table 7-21: Generic I/Q 4-PAM Constellation

u_0u_1	4-PAM value
00	$-1/\sqrt{10}$
01	$+1/\sqrt{10}$
10	$-3/\sqrt{10}$
11	$+3/\sqrt{10}$

A predefined known 16QAM symbol is specified as $(I,Q) = (u_{I1}, u_{I0}, u_{Q1}, u_{Q0})$.

7.3.7.1.5 Direct-Sequence Spreading

When direct-sequence spreading is employed, the entire burst, including preamble, pilots and postamble, shall be scrambled by chip-by-chip multiplication by a pseudo-random sequence. The default sequence given in table 7-22; alternative sequences may be specified in the burst format definition (clause 6.4.6.4). The sequence shall be re-set to its beginning at the start of each burst and shall be repeated as required to scramble the complete burst.

Table 7-22: Direct-sequence default scrambling sequence

1	1	1	1	-1	1	-1	-1	-1	-1	1	1	1	-1	-1	1	-1	1
1	1	1	1	1	1	-1	1	1	1	-1	-1	-1	1	1	1	-1	1
1	-1	1	-1	-1	-1	1	1	1	1	1	1	-1	-1	1	1	-1	1
1	-1	1	1	-1	-1	1	-1	-1	-1	1	1	-1	1	1	1	1	1
-1	1	-1	1	-1	-1	1	-1	-1	1	-1	1	-1	-1	1	1	-1	1
-1	-1	1	1	1	1	-1	-1	-1	-1	-1	1	-1	-1	1	-1	-1	-1
-1	1	-1	1	-1	-1	-1	1	-1	1	1	1	-1	1	1	1	1	-1
-1	1	-1	-1	1	1	1	1	-1	-1	-1	1	1	-1	-1	-1	-1	1
-1	-1	1	1	1	-1	1	-1	-1	1	-1	1	1	-1	1	1	1	-1
1	-1	1	1	-1	1	-1	1	-1	1	1	-1	-1	-1	1	-1	-1	-1
1	-1	-1	1	1	-1	-1	-1	-1	1	-1	-1	-1	-1	-1	-1	1	-1
1	1	-1	-1	1	1	-1	-1	1	-1	1	-1	1	1	1	-1	-1	1
1	1	1	1	-1	-1	-1	1	-1	1	-1	1	-1	1	-1	-1	-1	-1
-1	1	1	-1	1	-1	1	1	1	1	-1	1	1	-1	-1	-1	-1	-1
-1	-1	-1	1	1	1	1	1	1	1	-1	1	1	-1	-1	-1	-1	-1

An example of the shift register based generation of the scrambling sequence is shown in the following. Assume it is desired to use the polynomial $1 + x + x^6 + x^{10} + x^{14}$. Recalling that the '1' is implied, the scrambling_poly field is correspondingly coded as 0x2221. The desired initial value is (in order from x^1 to x^{14}) 1 0 0 1 1 1 1 0 1 1 1 1 0. Hence the scrambling_init field is coded as 0x1F79. The topology, initial state and first few bits of sequence are illustrated in figure 7-22.

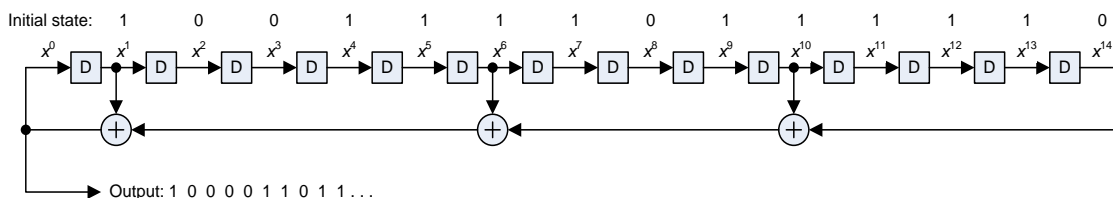

Figure 7-22: Example scrambling sequence generation

7.3.7.2 Continuous Phase Modulation of Burst

7.3.7.2.0 Introduction

The pulse shaping and quadrature modulation for continuous phase modulation are described in clause 7.3.7.2.1.

7.3.7.2.1 Continuous Phase Modulation Signal and Pulse Shaping

The complex baseband CPM signal is given by:

$$s(t) = \sqrt{\frac{2E_s}{T_s}} \exp(j\varphi(t)),$$

where T_s is the symbol duration. The CPM phase $\varphi(t)$ is given by:

$$\varphi(t) = 2\pi h \sum_{i=0}^{\infty} a_i q(t - iT_s), t \geq 0.$$

Where:

- a_i is the input symbol to the modulator, such that $a_i \in \{\pm 1, \pm 3\}$.
- h is the modulation index and is a rational number of the form $h = m_h/p_h$.
- $q(t)$ is the CPM phase response and is a continuous function, such that:

$$q(t) = \begin{cases} 0, & t < 0 \\ \int_0^t g(\tau) d\tau, & 0 \leq t \leq LT_s \\ 0, & t > LT_s \end{cases} \quad q(t) = \begin{cases} 0, & t < 0 \\ \int_0^t g(\tau) d\tau, & 0 \leq t \leq LT_s \\ 0, & t > LT_s \end{cases}$$

where L is the memory of the modulation, and is set to $L=2$.

The pulse shape, known as the weighted average (AV) CPM pulse shape is a linear combination of the Raised-Cosine (RC) and rectangular (REC) pulse shapes, such that:

$$g_{AV}(t) = \alpha_{RC} g_{RC}(t) + (1 - \alpha_{RC}) g_{REC}(t), \text{ where:}$$

$$g_{RC}(t) = \begin{cases} \frac{1}{4T_s} \left(1 - \cos \frac{\pi t}{T_s} \right), & 0 \leq t \leq 2T_s \\ 0, & \text{otherwise} \end{cases} \quad \text{and} \quad g_{REC}(t) = \begin{cases} \frac{1}{4T_s}, & 0 \leq t \leq 2T_s \\ 0, & \text{otherwise} \end{cases}$$

and $0 \leq \alpha_{RC} \leq 1$. Figure 7-23 shows the phase response $q_{AV}(t)$ when $\alpha_{RC} = 0,75$. Also the phase response functions for the RC and REC pulse shapes are shown. The samples of $q_{AV}(t)$ at different values of α_{RC} are given in annex C.

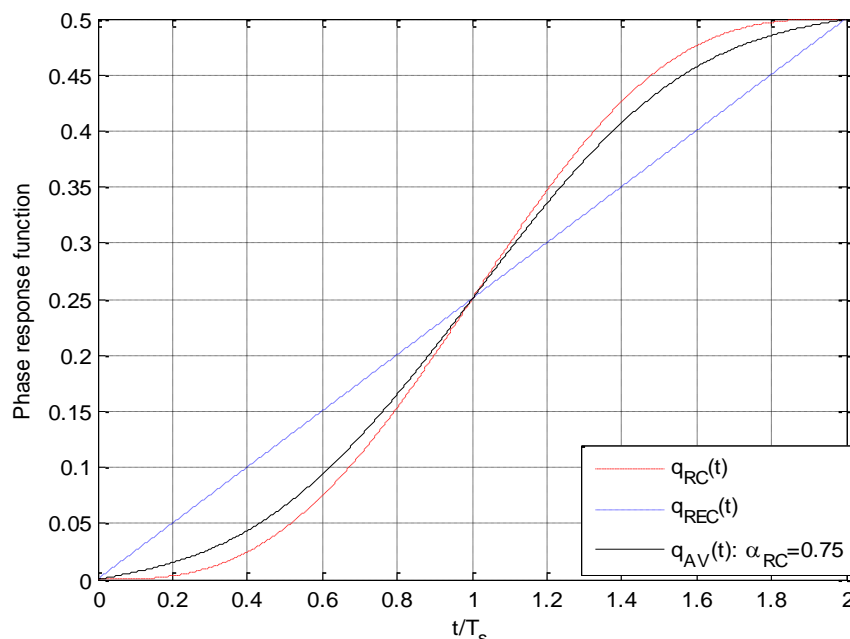

Figure 7-23: Phase response for RC, REC and AV pulse shapes

7.3.7.2.2 Continuous Phase Modulation Bit to Symbol Mapping

The FEC encoded bit sequence, after interleaving, is mapped to symbols as specified in this clause. When the modulation index $h = 1/3$, the bit to symbol mapping is given by table 7-23. For the remaining modulation indices, Gray mapping is used as indicated in table 7-24. If the length of the bit sequence at the interleaver output is not exactly divisible by $\log_2 M$, a bit 0 is appended at the end of the interleaved bit sequence prior to applying the bit to symbol mapping.

Table 7-23: Bit to Symbol mapping for $h = 1/3$

MSB	LSB	Symbol value
0	0	-3
0	1	-1
1	0	1
1	1	3

Table 7-24: Bit to Symbol mapping for $h \neq 1/3$ $h \neq 1/3$

MSB	LSB	Symbol value
0	0	-3
0	1	-1
1	1	1
1	0	3

7.3.7.2.3 Phase Trellis Termination

Phase trellis termination involves driving the CPM modulator to the all-zero state. The additional symbols required to do so are known as the tail-symbols. The tail-symbols will depend upon the phase state of the modulator, after the N_s data symbols $a_0, a_1, \dots, a_{N_s-1}$ are fed to the modulator.

Let $V_n \in \{0, 1, \dots, p_h - 1\}$ be the phase state of the modulator when the first tail symbol t_0 arrives at the modulo- p_h adder. The tail symbols required for phase trellis termination at different values of p_h are given in tables 7-25 to 7-28.

Table 7-25: Phase trellis termination symbols when $M = 4$, $L = 2$, $p_h = 7$

V_n	t_0	t_1	t_2
0	0	0	0
1	3	3	0
2	3	2	0
3	3	1	0
4	3	0	0
5	2	0	0
6	1	0	0

Table 7-26: Phase trellis termination symbols when $M = 4$, $L = 2$, $p_h = 5$

V_n	t_0	t_1	t_2
0	0	0	0
1	3	1	0
2	3	0	0
3	2	0	0
4	1	0	0

Table 7-27: Phase trellis termination symbols when $M = 4$, $L = 2$, $p_h = 4$

V_n	t_0	t_1
0	0	0
1	3	0
2	2	0
3	1	0

Table 7-28: Phase trellis termination symbols when $M = 4$, $L = 2$, $p_h = 3$

V_n	t_0	t_1
0	0	0
1	2	0
2	1	0

7.3.8 Burst Transmission Power Envelope

The RCST shall keep the EIRP for TC-LM bursts within the mask shown in figure 7-24.

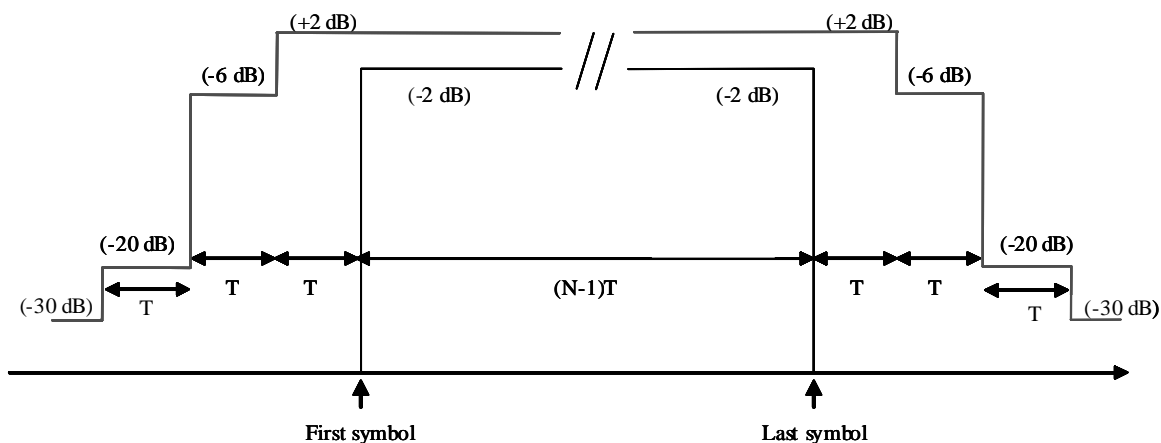

Figure 7-24: Burst power envelope mask for TC-LM bursts

The RCST shall keep the EIRP for CC-CPM bursts within the mask shown in figure 7-25.

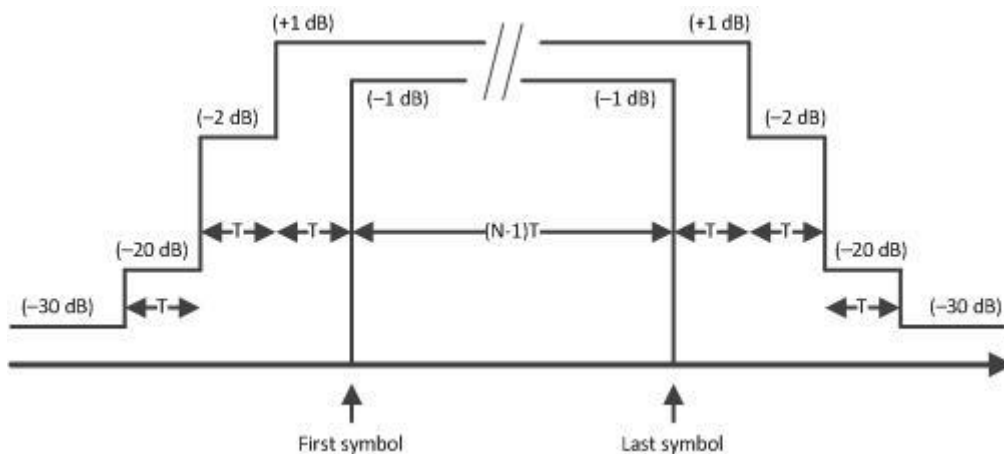

Figure 7-25: Burst power envelope mask for CC-CPM bursts

The RCST shall indicate to the NCC in conjunction with logon the following:

- The difference in peak emitted power that applies when changing the transmitter frequency in the logon request or as soon as possible after logon, by LL signalling, in the EIRP dependency field either in the logon request or in a control burst.
- The difference in the highest available emitted power that applies in the current configuration when changing between burst transmission modes using different types of modulation. This shall either be sent in the logon request or as soon as possible after logon by LL signalling, in the EIRP dependency field either in the logon request or in a control burst.

The RCST shall for any transmission type limit the power emitted into the different adjacent channels relative to the threshold noise level with an offset as indicated in table 7-29. This requirement is independent of any lower layer power control instruction given by the NCC. The threshold noise level is defined to be at a power level that is at the currently emitted in-band power level minus the threshold E_s/N_0 .

Table 7-29: Thresholds for relative emitted power into adjacent channels of the same BW as the in-band channel (including roll-off)

Channel offset of adjacent channel, given in in-band channel units	Highest emitted channel power level, with reference to the threshold noise level
1	-13 dB
2	-19 dB
≥ 3	-25 dB

The NCC shall indicate the threshold E_s/N_0 to be assumed for each transmission type (nominally the sensitivity for the transmission type) specified in the BCT.

The on-axis EIRP is system dependent.

There are regional regulatory regulations that concern off-axis EIRP. Such regulations do have impact on the design of equipment and the rules for operation of equipment, and implicitly also on the present document.

The EIRP may be controlled as specified in clause 9.9.1. The RCST shall take into account all EIRP adjustments received at least 90 ms in advance of transmission start. The EIRP used for the logon burst shall be within the specified limits, but is otherwise implementation dependent.

7.3.9 Transmission Burst Timing

7.3.9.0 Introduction

Accurate synchronization of the RCST transmissions is an important feature of the satellite interactive network. Constraints are imposed on the RCSTs to obtain an efficient TDMA system with minimum interference between RCSTs and maximum throughput (although these constraints may be relaxed if the receiver performs tasks such as satellite frequency translation error and common-mode Doppler compensation for RCST carrier frequency). For this reason, the synchronization scheme is based on information contained within the Forward Link Signalling as follows:

- Broadcast of the Network Clock Reference (NCR).
- Broadcast of the return link satellite position in the SPT or SAT.
- Optional broadcast of nominal timing offset in the initial transmission timing in the FAT.
- Broadcast of the burst time plan in the SCT, FCT2, BCT and TBTP2.
- Transmission timing adjustment for each RCST transmitted in TIM-U and CMT.

The forward link that carries the Forward Link Signalling contains a NCR counter which provides a 27 MHz clock reference as well as a time reference to the RCSTs connected to the forward link. The NCR shall be fed on the forward link with an accuracy of 5 ppm or better. The minimum NCR value injection frequency is 10 pps. The RCST shall use the NCR as the timing reference for the burst transmission.

To minimize truncation errors, the N LSB bits of the scaled value in the transmission timing adjustments shall be set to an approximate mid-range value of "1" followed by "0"s, with N being the value of the Burst_time_scaling field. For example, with N = 2, the resulting clock count value is "dd dddd dd10".

7.3.9.1 Burst Transmission Start Accuracy

The transmission of the logon burst shall accurately adapt to the timing indicated for the superframe sequence as referenced to the NCR received from the forward link, as if the NCR propagated from the return link satellite, offset by the optional Timing Offset Descriptor if this is provided in the FAT (or as part of the NCR TS packet, when considering a TS Packet stream). The propagation delay compensation shall nominally reflect the propagation delay between the nominal position of the RCST as provided to the RCST and the nominal position of the return link satellite as indicated by the NCC via the SPT or SAT. Before issuing the logon burst, the RCST shall calculate the satellite ranges for both forward and return links using the satellite ephemeris data contained within the most recent Satellite Position Table (SPT or SAT) plus knowledge of its own location (latitude, longitude and height above sea level). It shall use these ranges to calculate the corresponding satellite to RCST and RCST to satellite propagation delays. A nominal satellite position that may be found in the NIT shall be used if the NCC does not transmit the SPT or SAT.

The logon burst transmission start accuracy relative to SPT, SAT, NCR, SCT, FCT2, BCT and the optional Timing Offset Descriptor, and the nominal location of the RCST administratively made known to the RCST shall be as indicated in table 7-30.

Table 7-30: Maximum Allowed Deviation in Logon Burst Transmission Start Time

Forward link rate	Maximum allowed deviation
< 2 Msps	17 microseconds + 1 return link symbol period
2 Msps to 10 Msps	9 microseconds + 1 return link symbol period
> 10 Msps	2 microseconds + 1 return link symbol period

The RCST shall additively offset transmission start of succeeding transmission bursts as instructed by the NCC in the Correction Message Descriptor provided in TIM-U and the Correction Message Table. The RCST shall support a control resolution of 1 NCR tick in this process. The RCST shall take into account all timing corrections received at least 90 ms in advance of transmission start.

The TIM-U may contain multiple CMDs that each has independent scaling factors. All the corrections of the CMDs of a TIM-U shall be used for adjustment of the timing.

Burst transmission time start accuracy shall for any burst be within 50 % of a symbol period relative to the nominal start time. The burst transmission time accuracy is the worst case deviation between the scheduled start of a burst transmission and the actual start of the burst transmission. The scheduled start of burst transmission is the nominal point in time where the RCST should start transmission according to the NCR, the BTP and the received timing corrections.

7.3.9.2 Symbol Clock Accuracy

Symbol clock accuracy shall be within 20 ppm from the nominal symbol rate. The symbol clock rate shall have a short-term stability that limits the time error of any symbol within a burst to 1/20 symbol duration.

7.3.9.3 Carrier Frequency Accuracy

The carrier frequency accuracy shall be better than 10^{-8} (root mean square) relative to the nominal carrier frequency. Each logon burst shall be issued at the nominal carrier frequency indicated by the SCT/FCT2 for the specific logon timeslot. Other bursts shall be issued at a nominal carrier frequency offset relative to SCT/FCT2 resulting from the accrued frequency corrections received in CMD in TIM-U and CMT, and in a Satellite Return Link descriptor in TIM-U if the operational SFS is assigned this way. The RCST shall take into account all frequency corrections received at least 90 ms in advance of transmission start.

7.4 Void

7.5 The Return Link Structure (MF-TDMA)

7.5.0 Introduction

This clause specifies the structure of the multi-frequency TDMA return link.

MF-TDMA allows e.g. a group of RCSTs to communicate with a gateway sharing a set of carrier frequencies, each of which is divided into timeslots for burst transmission. A burst is defined by carrier frequency, bandwidth, start time, duration, the type of burst payload content to be issued and other characteristics.

7.5.1 Segmentation of the Return Link Resources

7.5.1.0 Introduction

The timeslots of the MF-TDMA carriers are organized and numbered so that the NCC easily and efficiently can refer to individual timeslots in the allocation process. The largest entity is the super-frame, composed of frames that are again composed of timeslots. Each timeslot is constructed from a number of equal Bandwidth-Time Units (BTU). Each frame is constructed of timeslots that are constructed of multiples of one BTU type.

7.5.1.1 Superframe

A superframe is composed of frames as shown in figure 7-26, themselves composed of slots limited in time and frequency, called timeslots. The frame is at an intermediate level between the superframe and the timeslots. It is introduced for reasons of signalling efficiency (forward link signalling). The superframe may be implemented with frames in non-adjacent frequency bands.

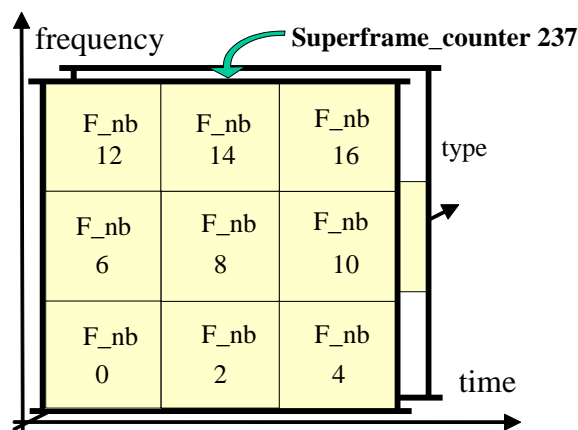

Figure 7-26: Example of superframe composition

In a superframe, the frames are numbered from 0 (lowest burst centre frequency, first in start time, lowest in frame type ID) to N (highest carrier frequency, last in start time, highest in frame type), ordered, with falling precedence, according to ascending lowest burst centre frequency, ascending start time and then ascending frame type as shown in the example in figure 7-26. N shall be less than or equal to 255.

The superframe and its frames may have the same duration, in which case each frame is constricted to a frequency sub-band of the superframe. The frames of a superframe may also differ in duration as well as bandwidth and timeslot composition, and figure 7-26 shows an example of a superframe with a duration 3 times a unified frame duration as well as with frames occupying the same time and frequency space.

The superframe duration is system dependent. An RCST shall support operation in superframes ranging in duration from 25 ms to 750 ms and may support operation with superframe durations outside this range.

7.5.1.2 Superframe Sequence

A superframe sequence (SFS) is a portion of frequency bandwidth of the return link, not necessarily contiguous, constituted by a consecutive sequence of superframes of a dedicated superframe type. Each superframe of the superframe sequence is equally delimited in duration and bandwidth occupation as specified for the associated superframe type.

The SFS identifies a set of MF-TDMA resources within the network. Figure 7-27 shows an example where two superframe sequences refer to non-overlapping sets of carrier frequencies in two respective contiguous sections of bandwidth.

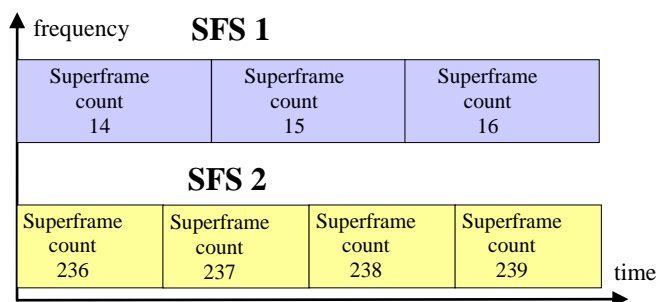

Figure 7-27: Example of superframe sequences

The MF-TDMA capacity may be segmented by allocating RCSTs to different superframe sequences, and the interactive network will then manage several concurrent superframe sequences. In the following, only one superframe sequence as defined by a single superframe type is considered.

As illustrated by figure 7-27, the consecutive superframes of a given superframe sequence are contiguous in time. Each consecutive occurrence of a superframe in the superframe sequence is associated with an incremented modulo 65 536 numbers called "superframe_count".

The RCST shall be able to keep track of dynamically assigned timeslots for traffic assigned up to 1 second in advance of its use, referring to operation on a superframe sequence. This concerns the operational interactive state control timeslots and traffic timeslots for random access as well as dedicated access to the specific RCST.

The RCST shall be capable of keeping track of logon timeslots assigned in maximum advance as specified in clause 9.2.3.

This timeslot handling capacity should be considered in conjunction with the construction of the superframe, the scheduling of the signalling of the assignments/allocations and the capacity of the services to be supported.

7.5.1.3 Frame

A frame is delimited in time equal to or shorter than the duration of the parent superframe and may span several frequency bands that do not have to be adjacent. Each frame is dedicated to a specific transmission format class. The different variants of transmission format classes that are recognized are listed in table 7-31. The table also shows which format classes that may be combined in an SFS. Support of operation on a superframe sequence that contains frames of other format class combinations is implementation dependent.

The frame is composed of Bandwidth-Time Units (BTU) of one single type organized as one or more BW limited time sequences of contiguous BTUs, each sequence spanning the duration of the frame in one frequency sub-band. The timeslots in the frame are composed of one BTU or several BTUs adjacent in time. Figure 7-28 illustrates a frame type implemented over sequences of 'x' BTUs over 'y' adjacent frequency bands where all the BTUs are of the generic ('G') type used for aggregation indicated by the TBTP2. Figure 7-29 illustrates a frame type where several BTU have been allocated to specific timeslots and transmission types by the specification of the frame type.

The symbol rate is determined by the BTU. Thus, all the timeslots of the frame use equal symbol rate and spans equal BW.

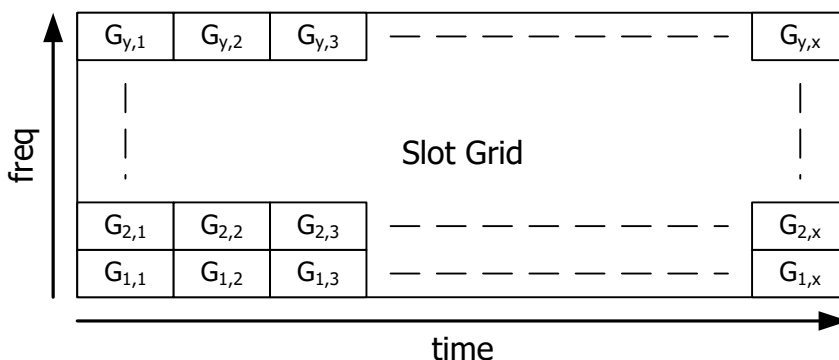

Figure 7-28: A Frame Implemented by 'x' BTUs of Type 'G' per Carrier in 'y' Adjacent Carriers

A frame type identifies a particular relative arrangement of timeslots aggregated from one type of BTU. For example, frame_type = 1 could identify a sequence of 10 "user traffic" timeslots on the same carrier, and frame_type = 2 a sequence of 4 "control" timeslots followed by 8 "user traffic" timeslots, all on the same carrier. A frame type may also span several carriers with a relative offset.

A frame type may refer to consecutive timeslots, each of a single BTU that are not allocated to a specific transmission type in advance but instead aggregated in consecutive sequences and each timeslot aggregate mapped to a specific transmission type matching the aggregate, indicated to the RCST just in time by using the TBTP2.

Figure 7-29 illustrates how a frame type may be composed of different timeslot types. The basis for a frame type is a regular grid of BTUs of the frame type BTU that is seen behind the timeslots. In this specific frame type, some timeslots occupy one BTU, 'TRF1' timeslots 2 BTUs and 'TRF2' timeslots 6 BTUs. The timeslots marked 'G' indicate general-purpose one-BTU timeslots that may be aggregated just in time by the TBTP2 to constitute larger timeslots that may hold different burst types. The TBTP2 refers to a transmission type specified in the BCT when assigning a 'G' timeslot. 'CB' indicates a permanent timeslot for a control burst and 'LB' indicates a permanent timeslot for a logon burst. The RCST shall process each TBTP2 message applicable for its context to extract the timeslot allocations.

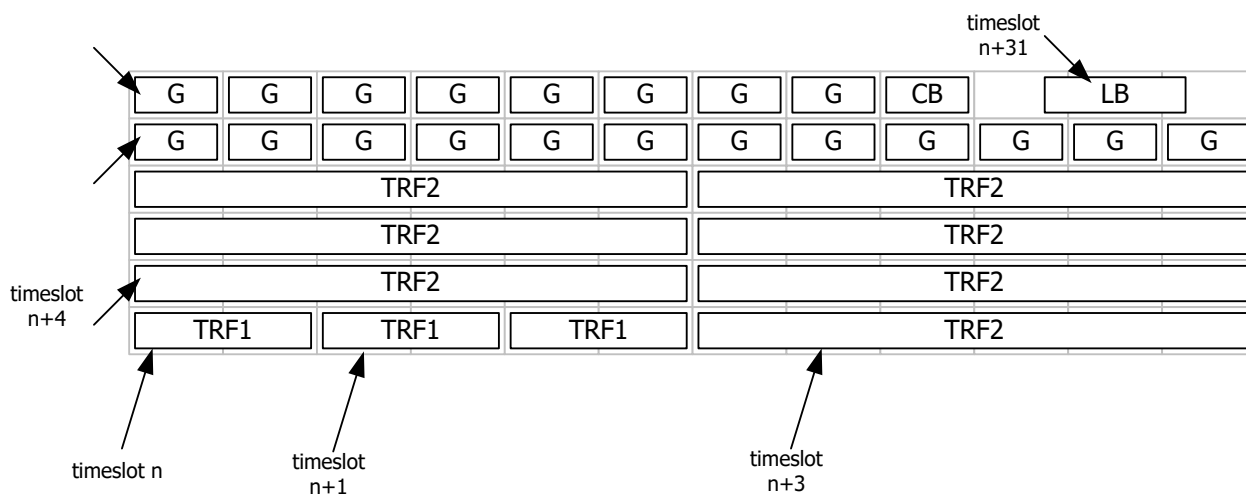

Figure 7-29: Example of the Composition of a Frame Type

The timeslots are numbered from 0 (lowest in carrier frequency and first in time) to M (highest in carrier frequency and last in time), ordered in falling precedence first according to ascending carrier frequency and then according to ascending time as illustrated in the example in figure 7-29. M shall be less than or equal to 2 047. In the example the frame type is defined with a time axis BTU count of 12, and there are 6 adjacent carriers created by specifying 5 offset frequencies for the frame type e.g. at 1x, 2x, 3x, 4x and 5x the BTU BW. The timeslots are in this example specified partly permanently by the frame type by use of 5 transmission type repetition sections, one for TRF1 timeslots, one for TRF2 timeslots, one for G timeslots, one for CB timeslot and one for the LB timeslot. Alternatively, the same timeslots could all have been specified in the frame type as being of the G type, using only one transmission type repetition section with 72 G timeslots where the TBTP2 would be used to map TRF1, TRF2 and LB timeslots/bursts into the G grid, and the Control Assign descriptor or TBTP2 would be used to map the CB timeslot/burst to a G timeslot.

Each timeslot is identified to the RCST by a specific permutation of SFS, Superframe Count, Frame Number and Timeslot Number relative to the current value of NCR and the current BTP. The central resource controller has the responsibility for avoiding an apparently dedicated assignment of a space in frequency and time to more than one RCST.

7.5.1.4 Timeslot

Figure 7-30 shows the burst TRF2 in its nominal position inside a timeslot built from 6 BTUs. The burst could principally fill the whole timeslot. Some timing guard is needed to avoid inter-burst interference. The actual burst is thus shorter than the timeslot. It is aligned with a nominal offset to the timeslot start.

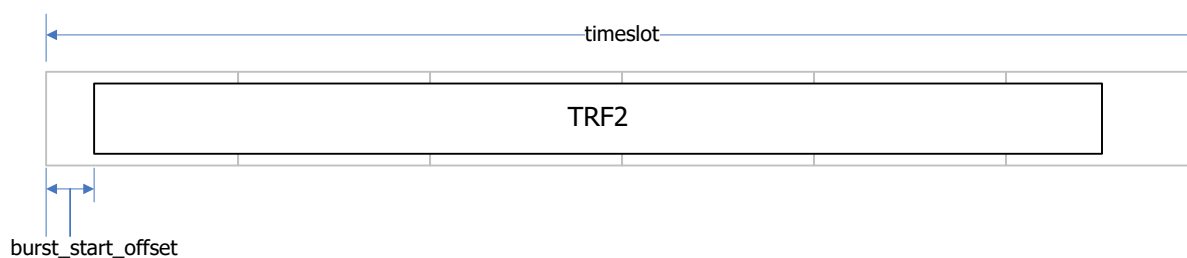

Figure 7-30: Example of a Burst in a Timeslot Built from 6 BTUs

7.5.2 Guard time

Separation of consecutive transmission bursts on the same carrier is intended supported by a nominal guard time as indicated in figure 7-30, to allow for RCST power ramping transients and errors in the transmission timing. Guard time is allocated by the NCC and may differ for the timeslots. The required guard time is system dependant and it is determined by the system design.

The leading and trailing guard time for a specific burst are determined by the combination of the size of the burst, the size of the two adjacent bursts, the size of the timeslots associated to the bursts and the nominal burst offset for each of the bursts. The NCC controls these parameters via the FCT2, the BCT and the TBTP2. The BCT specifies the alignment of a burst in a block of consecutive BTUs.

7.5.3 The Dynamic MF-TDMA Transmission Channel

This clause defines the Multi-Frequency Time Division Multiple Access (MF-TDMA) transmission channel. MF-TDMA allows a group of RCSTs to communicate using a set of carrier frequencies, each of which is divided into timeslots. The NCC will allocate to each active RCST a number of timeslots/bursts pairs, each defined by a number of parameters including modulation scheme, coding rate, frequency, symbol rate, start time and duration. This constitutes the Transmission Channel for an RCST, as shown in figure 4-3.

Any of these characteristics may change between successive bursts, provided the sets of parameters are among those made available for the current BTP (SCT, FCT2, and BCT). Changes to this semi-static part of the BTP may occur only on superframe boundaries, with a minimum advance in time as specified in clause 7.2.7. The dynamic principle is illustrated in figure 7-31, where the arrows show how an RCST uses successive timeslots with different bandwidths and durations.

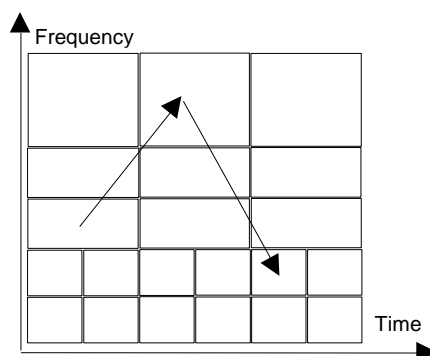

Figure 7-31: Dynamic MF-TDMA

The RCST may not be capable of switching dynamically between linear modulation and constant-envelope modulation during a log-on session.

The frequency agility of an RCST is specified in terms of long term frequency tuning and rapid burst-to-burst carrier switching. Long-term frequency tuning represents a change in centre frequency of the carrier switching band. The settling time for a long-term frequency tuning shall not exceed 1 s.

The different transmission formats are grouped in transmission format classes where each class is distinguished by some shared major characteristics of the transmission format. The different variants of transmission format classes that are recognized are listed in table 7-31. The table also shows which format classes may apply for switching to or from.

Table 7-31: Transmission Format Class Variants

Transmission Format Class	Classes Applicable for Switching to/from
Linear Modulation Bursts	Continuous Transmission, Spread-Spectrum Linear Modulation Bursts
Continuous Phase Modulation Bursts	
Continuous Transmission	Linear Modulation Bursts, Spread-Spectrum Linear Modulation Bursts
Spread-Spectrum Linear Modulation Bursts	Linear Modulation Bursts, Continuous Transmission
User defined Format Classes	

The ability of the RCST to perform burst-to-burst carrier switching within a burst-based transmission format class is distinguished as "fast" or "slow". "Fast" carrier switching is defined as the ability to transmit in adjoining timeslots on any frequency within the switching band. "Slow" carrier switching is defined as the ability to transmit on any frequency within the switching band when the transmitter is allowed at least a minimum idle interval between transmission timeslots as indicated in table 7-32.

An RCST shall indicate its ability to perform either fast or slow carrier switching, and also its switching band for doing this.

Table 7-32: Minimum Guard Interval as a Function of Carrier Frequency Change

Carrier frequency change	Minimum idle interval
0 MHz to 36 MHz	400 μ s
36 MHz to 125 MHz	600 μ s
125 MHz to 250 MHz	800 μ s
250 MHz to 500 MHz	1 ms

When switching to a transmission type belonging to another transmission format class than the one currently used, the switching latency is implementation dependent and may even imply a reboot of the RCST. The latency shall however not exceed 2 s for switching to and from the optional continuous carrier transmission, when this is supported.

7.5.4 The Frequency Range of the Dynamic Transmission Channel

An RCST has a well-defined minimum band for the carrier frequency switching from time-slot to time-slot. Change to a frequency outside this minimum band may be implemented by the slower carrier frequency tuning mechanism. The RCST indicates the size of the switching band to the NCC. The minimum carrier frequency switching step supported by an RCST shall be at least $\pm 50\%$ of the minimum band for the switching class claimed supported, aligned with the centre frequency of the band in use, for the different classes of carrier switching ranges defined in table 7-33. Change of carrier frequency in excess of this range is considered retuning and out of scope for the fast and slow carrier frequency switching performance requirements.

Table 7-33: The different carrier switching classes

Carrier switching class	Minimum band size
Class 1	36 MHz
Class 2	125 MHz
Class 3	250 MHz
Class 4	500 MHz

7.6 Return Link Continuous Carrier (Option)

The RCST can as an option employ a continuous carrier mode of transmission in accordance with the provisions in this clause. The ability to operate in this manner shall be signalled in the logon PDU. An RCST declaring support for continuous carrier operation shall be capable of transmitting either a continuous carrier or an MF-TDMA signal as instructed, but need not be able to transmit both simultaneously. Continuous-carrier operation modifies the RCST state machine as defined in clause 9.2.8.

The RCST shall limit adjacent channel power emission for continuous transmission similarly as specified for burst transmission in clause 7.3.8. The autonomous back-off level indicated to the NCC at logon also applies to continuous transmission.

There are two variants of continuous-carrier operation. In the so-called "non-persistent mode", the RCST will autonomously revert to TDMA operation when the continuous carrier assignment expires without renewal and following log-off and TX Disable instructions. In "persistent mode", the RCST will not autonomously revert to TDMA, even following a power cycle, and will autonomously resume CC transmission unless it receives an explicit carrier revocation.

Capacity requests and carrier requests are specified in clause 7.2.6. Carrier assignment is specified in clause 7.2.8.

Continuous return link carriers are specified and referred to by the same means as used for MF-TDMA timeslots. In the FCT2, a frame_type can define one or more carriers for continuous transmission, all with the same symbol-rate. A frame_type cannot define a mix of continuous carriers and MF-TDMA carriers. A superframe with multiple frames can however apply a mix of such frame_types. Assignment of any timeslot on a carrier of a frame for continuous transmission shall be understood to apply to the entire carrier. Such frames form part of a Superframe Sequence in the same manner as other frames. A pair of frames in the same superframe may refer to the same frequency BW, one being specified for continuous transmission and the other for burst transmission. The BCT contains specifications/references for continuous carrier waveforms with identification of their respective tx_types, parallel to burst waveform specifications/references and corresponding tx_types.

The continuous carrier is organized in carrier frames. Each carrier frame consists of a number of code words with uniform size, code rate, modulation and spreading factor, corresponding to a particular tx_type. The carrier frame further contains a number of known symbols, organized in a preamble and distributed pilot blocks. Subsequent carrier frames may use different tx_types.

NOTE 1: The carrier frame is distinct from the frame implicitly referred to by the term "Frame PDU", as it may hold a number of Frame PDUs.

The construction of each carrier frame is illustrated in figure 7-32 and described in this clause. Some elements are optional, as defined in the BCT or by default for the waveform in question, as referred to by the tx_type specification in the BCT. The parameters characterizing the waveform are defined in table 6-24. Reference waveforms are specified in Annex A.

The carrier frame is constructed as follows, referring to the numbered stages in figure 7-32:

- 1) User data SDUs and control PDUs are encapsulated in accordance with clause 7.1 and clause 7.2, and organized in code block payloads. Each code block payload corresponds to one Frame PDU.
- 2) Each code block payload is scrambled for energy dispersal using the same method as defined in clause 7.3.3, and the CRC is appended as specified in clause 7.3.4.
- 3) Each scrambled block appended with CRC is FEC encoded using the turbo code defined in clause 7.3.5.1.
- 4) The coded bits of each block are mapped to modulation symbols using the same rules as defined in clause 7.3.7.1.4.

NOTE 2: In some cases this may involve appending trailing "stuffing bits" to achieve an integer number of symbols per code block.

- 5) The carrier frame payload is constructed by concatenating the required number of blocks of modulated symbols.
- 6) The symbols are each repeated SF times, where SF is the desired spreading factor. Operation with $SF > 1$ shall be supported if spread-spectrum TDMA operation is supported. The sequence is further extended by a number of padding chips. The padding chips are pseudo-random, drawn from the symbol alphabet of the chip sequence.

NOTE 3: Padding chips may be used to achieve a uniform carrier frame duration among several combinations of block payload size, code rate, number of blocks, modulation and spreading factor.

- 7) A preamble is pre-pended and pilot chip blocks are inserted, applying the same rules as defined for burst transmission in clause 7.3.6.1, with the modification that references to bursts in said clause shall be understood to apply to carrier frames of the continuous carrier.
- 8) If so specified, the sequence of chips is multiplied by a (± 1) binary scrambling sequence. This sequence is reset at the beginning of every carrier frame. This scrambling sequence is a section of a PN-sequence, generated according to a specified polynomial and initial condition in the same manner as for spread-spectrum bursts (clause 7.3.7.1.5).

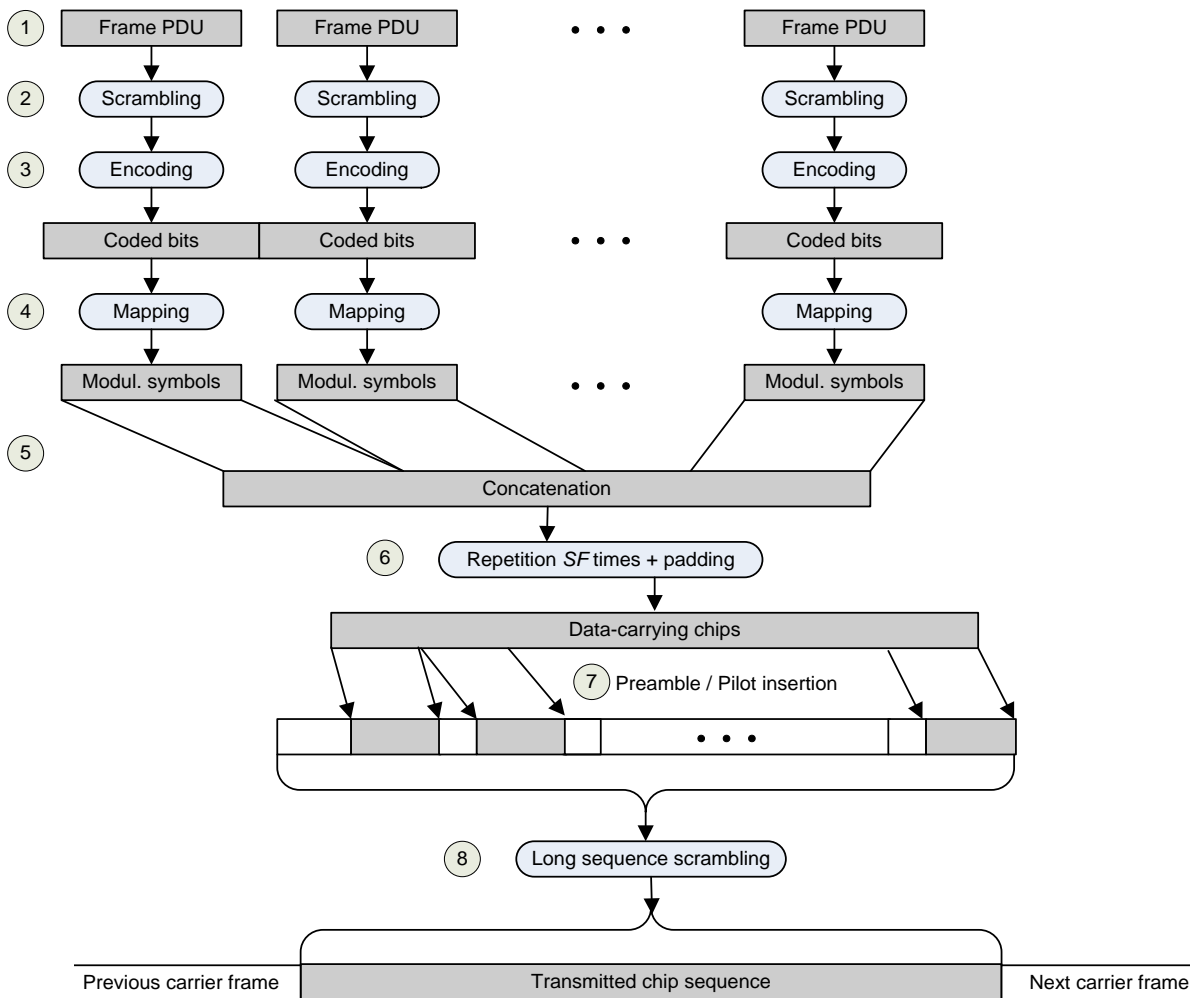

Figure 7-32: Continuous carrier frame construction

With basic CC support the RCST may resort to support a single Frame PDU in the Carrier Frame, without spreading and without use of long-sequence scrambling. Then, all the padding required will appear at stage 4, and stages 5, 6 and 8 disappear or become trivial. With this limited support, a symbol sequence is transmitted on the carrier rather than a chip sequence.

8 Return Link L2S

8.0 Introduction

The lower layer signals in the return link are directed from an RCST to the NCC.

8.1 Transport of the Logon PDU

The logon burst holds one lower layer logon PDU. It supports lower layer logon to the interactive network. It may be sent at RCST discretion.

8.2 Transport of the Control PDU

8.2.1 Transport of Control PDU in Control Burst

The control burst holds one L2S control PDU. It supports transmission of control and status information to the NCC.

8.2.2 Transport of Control PDU multiplexed with higher layer PDUs

A network may support multiplexing of an L2S control PDU with higher layer PDUs. This is indicated by the traffic/control content type timeslot. A control PDU cannot be sent in the traffic-only timeslot content type timeslot.

8.3 Syntax and Coding of RL Signals for L2S

8.3.0 Introduction

The logon signals and the control signals are specified in this clause. There is as well included a specification of the CSC burst used in ETSI EN 301 790 [1] specifying how the RCST may indicate that it supports the present document, if the RCST logs on according to ETSI EN 301 790 [1].

8.3.1 Logon PDU content

The logon content is to be sent unfragmented in an FPDU in a timeslot dedicated to logon. The two byte PDU header is not used in this type of FPDU, neither is the ALPDU header. The Payload Label may hold the 48 bit RCST HID of the source. The logon content format and syntax is given in table 8-1.

Table 8-1: Logon FPDU content format and syntax

Syntax	No. of bits		Mnemonic
	Reserved	Information	
logon_content() {			
entry_type		4	uimsbf
access_status		4	uimsbf
for (k=0; k< N; k++) {			
for (m=0; m< M(k); m++) {			
logon_element_byte		8	uimsbf
}			
}			
}			
NOTE:	N is the number of logon elements and M(k) is the number of bytes in logon element k.		

- entry_type: A 4 bit field that indicates the entry type used by the RCST. The field is coded as indicated in table 8-2. The receiver shall treat reserved values as if reconnect was sent;

Table 8-2: Entry type codes

Value	Entry type	Description
0x0	request for pointing alignment support	request for pointing alignment support
0x1	subscription	bind user to HW and network
0x2	reconnect for traffic session	
0x3	reconnect for always-on	
0x4	reconnect and logoff	used e.g. for location update
0x5	alignment probe	alignment probe burst
0x6 to 0xF	Reserved	

- access_status: A 4 bit field that indicates the current access status as perceived by the RCST. The field is coded as indicated in table 8-3. Reserved values are interpreted as if zero was sent;

Table 8-3: Access status codes

Bitmask	Access status	Description
xxx1	'1' indicates that the NCC has confirmed physical alignment	Concerns the physical alignment of the RCST transmission done in the current ONID/INID and with the current satellite(s) (SATID)
xx1x	'1' indicates that the NCC has confirmed that the user is associated with the RCST	Concerns confirmation given by the current ONID/INID
x1xx	'1' indicates that the NCC has confirmed that the higher layers have been initialized	Concerns the operation with reference to ONID/INID
1xxx	'1' indicates that NCC has confirmed that commissioning is completed	Concerns the commissioning done when controlled by the current ONID/INID

- `logon_element_byte`: This is one byte in the contiguous byte sequence of concatenated logon elements. First byte in each logon element has 4 bit type indication in the most significant part and the last 4 bits indicate the length of the trailing field in bytes. The logon element types are listed in table 8-4;

Table 8-4: Logon element types

Type value	Name	Logon element size	Description
0	Padding	n	Indicates padding of the given number of additional bytes in the length
1	User ID	n	A hash of the username of the subscriber/installation
2	Signature	n	A signature built using the password of the subscriber/operator of the installation
3	RCST lower layers capabilities	n	As specified in table 8-5
4	RCST higher layers capabilities	n	For the lower layers, transparent higher layer capabilities
5	Options requested	n	List of the DHCP-style options requested in the TIM-U response (from the set announced in TIM-B)
6	Position update	n	A mobility control format
7	SW and HW identifier	n	Implementation dependent SW and HW identifier
8	EIRP dependencies	2	Refer to table 8-14
9	MTU	3	Indicates the maximum SDU packet size in bytes that the RCST accepts for user traffic
10	Pointing alignment support indication	3	Indicates the support for pointing alignment probing
11	Alignment probe payload	n	Concatenation of the burst probe pattern assigned by the NCC
12 to 14	Reserved/yet unknown	n	
15	user defined	n	

- `UserID`: The (n-1) least significant bytes of the SHA-1 hash of the username with all characters converted to lowercase;
- `Signature`: The (n-1) least significant bytes of the SHA-1 hash of the concatenation of [username (in lowercase), password (in lowercase), RCST HID (48 bit), NIT-ONID(16 bit), RMT-INID(16 bit), RMT-NCC-ID (8 bit), SFS(8 bit), `supiframe_count`(16 bit), `frame_number`(16 bit), `timeslot_number`(16 bit)], referring to the lowest numbered timeslot of a concatenation of timeslots;
- `RCST lower layer capabilities`: As specified in table 8-5.

Table 8-5: RCST Lower Layer Capabilities Syntax

Syntax	No. of bits		Mnemonic
	Reserved (see note)	Information	
<code>lower_layer_capabilities() {</code>			
<code>multiple_GS_support</code>		2	<code>uimsbf</code>
<code>no_linear_support</code>		1	<code>bsblf</code>
<code>full_range_FL_MODCOD_support</code>		1	<code>bsblf</code>
<code>full_range_RL_MODCOD_support</code>		1	<code>bsblf</code>

Syntax	No. of bits		Mnemonic
	Reserved (see note)	Information	
fast_carrier_switching_support		1	bsblf
carrier_switching_class_supported		2	uimsbf
Es_N0_power_control_support		1	bsblf
constant_power_spectrum_density_support		1	bsblf
slotted_aloha_traffic_support		1	bsblf
crdsa_traffic_support		1	bsblf
continuous_carrier_support		3	bsblf
custom_cccpm_waveform_support		1	bsblf
service_support		4	uimsbf
nbrof_l2ifs_supported		4	uimsbf
SW_version		8	uimsbf
no_cpm_support		1	bsblf
dvb_s2x_support		1	bsblf
dvb_s2x_higher_modcods_support		1	bsblf
extended_lower_layer_capabilities		1	bsblf
dcp_ip_support		1	bsblf
dcp_l2_support		1	bsblf
regenerative_mesh_support		1	bsblf
transparent_mesh_support		1	bsblf
if (extended_lower_layer_capabilities == 1) {			
dvb_s2x_vlsnr_support		1	bsblf
fl_timeslicing_support		1	bsblf
NCRv2_support		1	bsblf
SAT_support		1	bsblf
Forward_link_v2 support		1	bsblf
reserved	3		bsblf
}			
}			
NOTE: Reserved bits are set to '0' to indicate implicit 'do not support' for potential new features recognized by future receivers. The length of the lower_layer_capabilities is 1 byte longer in case of extended lower layer capabilities present.			

Syntax of the lower_layer_capabilities parameters:

- multiple_GS_support: This 2 bit field indicates the type of continuous generic streams that the RCST supports receiving concurrently from the forward link multiplex. '0' indicates one stream, '1' indicates two streams, '2' and '3' are reserved;
- no_linear_support: This 1 bit field indicates if the RCST supports linear modulation. '0' indicates linear modulation is supported, '1' indicates linear modulation is not supported;
- full_range_FL_MODCOD_support: This 1 bit field indicates if the full range of forward link MODCODs as specified by ETSI EN 302 307-1 [2] is supported. '1' indicates that it is supported. '0' indicates that the limited range specified by ETSI TS 101 545-1 [i.15] is supported;
- full_range_RL_MODCOD_support: This 1 bit field indicates if the full range of return link MODCODs is supported as specified by the present document. '1' indicates that it is supported;
- fast_carrier_switching_support: This 1-bit field indicates whether the RCST supports fast carrier switching as defined in clause 7.5.3. A value of '1' indicates support;
- carrier_switching_class_supported: This 2 bit field indicates the carrier switching class as specified in clause 7.5.3. The value '0' indicates class 1, value '1' indicates class 2, value '2' indicates class 3 and value '3' indicates class 4;
- Es_N0_power_control_support: This 1 bit field indicates if the RCST supports autonomous power control based on E_s/N_0 reported by the NCC, as specified in clause 9.9.1. Value '1' indicates that it is supported;

- constant_power_spectrum_density_support: This 1 bit field indicates if the RCST supports constant power spectrum density power control, as specified in clause 9.9.1. Value '1' indicates that it is supported;
- slotted_aloha_traffic_support: This 1 bit field indicates if the RCST supports slotted aloha random access for higher layer traffic. Value '1' indicates that it is supported;
- crdsa_traffic_support: This 1 bit field indicates if the RCST supports CRDSA for higher layer traffic. Value '1' indicates that it is supported;
- continuous_carrier_support: This field indicates whether the RCST supports return link continuous carrier capabilities in accordance with the provisions given in clause 9.9.5.5. The field is encoded in accordance with table 8-6;

Table 8-6: Continuous carrier capability codes

Value	CC Support	Additional modulation scheme(s) supported
0	None	Not Applicable
1	Basic	None
2	Enhanced	None
3	Basic	16QAM
4	Enhanced	16QAM
5 to 7	Reserved	Reserved

- custom_cccpm_waveform_support: A 1 bit field that indicates if the RCST supports programming of custom CC-CPM waveforms, as specified in clause 6.4.6.2. The value 1 indicates this support;
- service_support: The number in this 4 bit field indicates the maximum number of concurrent lower layer services, the maximum number of concurrent request classes and the maximum number of concurrent dedicated access assignment IDs that the RCST supports in the connectivity to the NCC/gateway;
- nbrof_l2ifs_supported: A 4 bit field that indicates the number of layer 2 interfaces that the RCST supports for generic connection to higher layers, in addition to its layer 2 interface for internal IPv4 M&C. The value '0' indicates that the RCST only supports the layer 2 interface used for the internal IPv4 M&C in addition to its L2S interface;
- SW_version: 8 bit field indicating the SW version of the RCST;
- dvb_s2x_support: A 1 bit field that indicates if the RCST supports the DVB-S2X forward link interactive services profile normative parts. Value '1' indicates that it is supported;
- dvb_s2x_higher_modcods_support: A 1 bit field that indicates if the RCST supports the 128APSK, 256APSK and 256APSK-L modcods. Value '1' indicates that it is supported;
- extended_lower_layer_capabilities: This indicates that the extended lower layer capabilities signalling is present. Value '1' indicates that the extended lower layer capabilities signalling is present. Value '0' indicates that the extended lower layer capabilities signalling is absent. The extended lower layer capabilities shall not be present when the return link descriptor allow_extended_lower_layer_capabilities value is '0'.
- no_cpm_support: This 1 bit field indicates if the RCST supports cpm modulation. '0' indicates cpm modulation is supported, '1' indicates cpm modulation is not supported;
- dcp_ip_support: This 1 bit field indicates that the RCST supports DCP over IP as defined in ETSI TS 101 545-3 [i.16];
- dcp_l2_support: This 1 bit field indicates that the RCST supports DCP over L2 as defined in ETSI TS 101 545-3 [i.16];
- regenerative_mesh_support: This 1 bit field indicates that the RCST supports the regenerative mesh scenario as specified in ETSI TS 101 545-1 [i.15];
- transparent_mesh_support: This 1 bit field indicates that the RCST supports the regenerative mesh scenario as specified in ETSI TS 101 545-1 [i.15];

- `dvb_s2x_vlsnr_support`: A 1 bit field that indicates if the RCST supports the DVB-S2X forward link VL-SNR profile normative parts. Value '1' indicates that it is supported. If the RCST also supports the 64APSK and 64APSK-L modcods it shall also set the `dvb_s2x_support` to the value 1;
- `fl_timeslicing_support`: This 1 bit field indicates that the RCST supports Annex M of DVB-S2 in ETSI EN 302 307-1 [2]. Value '1' indicates that it is supported. When also `dvb_s2x_support` is set to 1, then this RCST will additionally also support Annex M for DVB-S2X in ETSI EN 302 307-1 [2];
- `NCRv2_support`: This 1 bit field indicates that the RCST supports the NCRv2 system. Value '1' indicates that it is supported;
- `SAT_support`: This 1 bit field indicates that the RCST supports the SAT. Value '1' indicates that it is supported;
- `Forward_link_v2_support`: This 1 bit field indicates that the RCST supports the `Forward_link_v2_descriptor`. Value '1' indicates that it is supported;
- `MTU`: A 16 bit field that indicates the maximum size of SDU that the RCST will accept at the data link layer for any choice of user traffic protocol (lower values than the default may be ignored);
- `Pointing alignment support indication`: An 8 bit field that indicates the supported methods for pointing alignment coded as shown in table 8-7;

Table 8-7: Pointing alignment support indicator content

MSB	LSB	Supported pointing alignment methods
128 to 255	User defined	User defined
2 to 127	Reserved	Reserved
1	Nominal CW EIRP in the pointing direction, in dBm	Burst probe, and CW probe by fixed non-configurable EIRP
0	Reserved	Burst probe, and CW probe by configurable EIRP

- `Alignment Probe Payload`: payload constructed by concatenating replicas of the `alignment_probe_pattern` to fill the space available for payload, starting from the byte indicating the element type and length. If there is only one byte space left this shall be filled with the MSB of the pattern.

8.3.2 Control PDU Content

The control content in an FPDU in a timeslot dedicated to control is to be sent unfragmented, neither including a PPDU header nor an ALPDU header. Control content can be sent as an ALPDU in traffic/control timeslots, possibly fragmented into several PPDUs. ALPDU Protocol Type and ALPDU Label are both omitted from the format when transmitting in a timeslot dedicated to control, but may be included when sent in a traffic/control type timeslots. Resolution of source and destination of the transmission is resolved by the MAC layer.

Table 8-8: Control PPDU content format and syntax

Syntax	No. of bits		Mnemonic
	Reserved	Information	
control_content() {			
if (tx_content_type==control) {			
RCST_status	1	2	uimsbf
power_headroom		5	uimsbf
if (transmission_standard < 3) {			
cni		8	uimsbf
least_margin_transmission_mode_request {			
mode_unknown	1	1	bsb1f
pilot_based_mode		1	bsb1f
modcod		5	bsb1f
}			
}			
else if (transmission_standard == 3) {			
dvbs2x_CNI_and_least_margin_transmission_mode		24	bsb1f
}			
}			
for (k=0; k< N; k++) {			
for (m=0; m< M(k); m++) {			see below
control_element_byte		8	uimsbf
}			
}			
}			
NOTE 1: Reserved bits are of type bsb1f, and shall precede the Information bits on the same line.			
NOTE 2: N is the number of control elements and M(k) is the number of bytes in control element k.			

The semantics of the control_content are as follows:

- tx_content_type: This parameter is equal to the content type of the transmission type used to transmit the control content. The content type of the transmission type is indicated by the BCT. Transmission types are assigned to timeslots by the FCT2 and by the TBTP2;
- RCST_status: This is a 2 bit field that indicates the current operational status of the RCST, with the following coding of values:

Table 8-9: RCST status coding

Status value	Status indication
3	Critical error
2	Major error
1	Attention
0	Normal operation

- power_headroom: This is a 5 bit field indicating the available headroom in RF power level as a difference between the maximum RF power level and the RF power level used to transmit this control message, coded as follows indicated in table 8-10;

Table 8-10: Power headroom coding

Value	Power headroom
31	Not known
30	≥ 15 dB
0 to 29	value x 0,5 dB

- cni: This is an 8 bit field that indicates the estimated carrier to noise-plus-interference ratio for the forward link at the RCST. The coding is as defined in ETSI EN 302 307-1 [2];

- `least_margin_transmission_mode`: This is an 8 bit structured field that is used to indicate the forward link transmission mode with least link margin that is useful for the RCST. The components are coded as follows:
 - `mode_unknown`: This is a 1 bit field that is "1" if the `least_margin_transmission_mode` holds a valid indication and "0" if the indication is not valid;
 - `pilot_based_mode`: This is a 1 bit field that is "1" if the requested transmission mode refers to a configuration set up with pilots and "0" if it is not pilot based;
 - `modcod`: This is a 5 bit field that indicates the modcod of the reported transmission mode coded as for the forward link baseband header in ETSI EN 302 307-1 [2].
- `dvbs2x_CNI_and_least_margin_transmission_mode`: This is a 24 bit structured field that is used to indicate the CNI and least transmission mode for DVB S2X. It is coded as follows:

Table 8-11: dvbs2x_modcod field content format and syntax

Syntax	No. of bits		Mnemonic
	Reserved	Information	
<code>dvbs2x_CNI_and_least_margin_transmission_mode() {</code>			
<code>dvbs2x_cni</code>		9	uimsbf
<code>dvbs2x_least_margin_transmission_mode_request {</code>			
<code>dvbs2x_mode_unknown</code>		1	
<code>dvbs2x_pilot_based_mode</code>		1	
<code>extended_modcod</code>	4	1	bslbf
<code>if (extended_modcod == 0) {</code>			
<code>normal_snr_modcod</code>	1	7	bslbf
<code>}</code>			uimsbf
<code>else if (extended_modcod == 1) {</code>			uimsbf
<code>vlsnr_modcod</code>	4	4	uimsbf
<code>}</code>			
<code>}</code>			
NOTE:	Reserved bits are of type bslbf, and shall precede the Information bits on the same line. They shall be set to 0.		

Semantics for `dvbs2x_CNI_and_least_margin_transmission_mode`:

- `dvbs2x_cni`: This is an 9 bit field that indicates the estimated carrier to noise-plus-interference ratio for the forward link at the RCST. The coding is as defined in clause D.5 of ETSI EN 302 307-2 [16];
- `dvbs2x_least_margin_transmission_mode`: This is a 16 bit structured field that is used to indicate the forward link transmission mode with least link margin that is useful for the RCST. The components are coded as follows:
 - `dvbs2x_mode_unknown`: This is a 1 bit field that is "1" if the `least_margin_transmission_mode` holds a valid indication and "0" if the indication is not valid;
 - `dvbs2x_pilot_based_mode`: This is a 1 bit field that is "1" if the requested transmission mode refers to a configuration set up with pilots and "0" if it is not pilot based;
 - `extended_modcod`: This is a 1 bit field that is set to '0' when the modcod is signalled in the Part 2 PLHEADER of ETSI EN 302 307-2 [16], the Annex M Time slicing PLHEADER of ETSI EN 302 307-2 [16] or Annex E of ETSI EN 302 307-2 [16] . It is set to '1' for the modcods that are signalled in the VL-SNR header of ETSI EN 302 307-2 [16];
 - `normal_snr_modcod`: This is a 7 bit field that contains b0-b1-b2-b3-b4-b5-b6 of the modcod as described in clause 5.5.2, clause E.3.4.2, clause E.3.5.2, clause E.3.6.3.3, E.3.7.3.3, E.3.8.3, or E.3.9.3 of ETSI EN 302 307-2 [16];
 - `vlsnr_modcod`: This is a 4 bit field that contains the Annex-I index pointing to the VL-SNR modcod in the list shown in Table 18b, clause 5.5.2.5 of ETSI EN 302 307-2 [16];

- control_element_byte: This is an 8 bit field that holds one byte of the M(k) byte control element k. The control_content contains N control elements. A control element can take one of the two formats as shown in table 8-12. The control element types are listed in table 8-13.

Table 8-12: Structure variants of the control element

Control element variant	Type field size	Length field size	Value field size
Well-known	1	0	M(k) - 1
Custom, Complex or Unknown	1	1	M(k) - 2

NOTE: The length field is omitted for the "well-known" element types.

Table 8-13: Control element types

Type value	Name	Variant	Control element size	Description
0	Padding start	Well-known	1	Indicates padding, also of the rest of the content
1	No operation	Well-known	1	Indicates a solitary padding byte
2	RCST status and power headroom	Well-known	2	To convey RCST status and the power headroom as found in the first byte when the tx content type is "control"
3	Higher Layer Capabilities	Custom	n	Used by the higher layers as required
4	RCST CNI and least margin transmission mode	Well-known	3	To convey the CNI and the least margin transmission mode as in the dedicated timeslot header
5	RCST maximum power headroom	Well-known	2	Indicates the maximum power headroom
6	EIRP dependency	Well-known	2	Indicates the most applicable EIRP dependency masks
7	M_and_C_Message	Well-known	3	Control message format
8	Logoff Cause	Well-known	2	Indicates the logoff cause as a supplement to the logoff indication
9	Mobility Control	Well-known	4	Mobility control format
10	Default MTU	Well-known	3	MTU that applies for FL if other instructions are not given
11	CC Control Message	Well-known	5	CC control message sent in the return link
12	RCST DVB-S2X CNI and least margin transmission mode	Well-known	4	To convey the CNI and the least margin transmission mode when S2x is used in the forward link
13	RCST DVB-S2X Annex E support	Well-known	3	To convey the optional support of Annex E superframes
32	Small CR, 1 CR	Well-known	3	
33	Small CR block, 2 CRs	Well-known	5	
34	Small CR block, 3 CRs	Well-known	7	
35	Small CR block, 4 CRs	Well-known	9	
36	Small CR block, 5 CRs	Well-known	11	
37	Small CR block, 6 CRs	Well-known	13	
38	Small CR block, 7 CRs	Well-known	15	
39	Small CR block, 8 CRs	Well-known	17	
40	Small CR block, 9 CRs	Well-known	19	
41	Small CR block, 10 CRs	Well-known	21	
42	Small CR block, 11 CRs	Well-known	23	
43	Small CR block, 12 CRs	Well-known	25	
44	Small CR block, 13 CRs	Well-known	27	
45	Small CR block, 14 CRs	Well-known	29	
-				
48	Large CR, 1 CR	Well-known	4	
49	Large CR block, 2 CRs	Well-known	7	
50	Large CR block, 3 CRs	Well-known	10	
51	Large CR block, 4 CRs	Well-known	13	
52	Large CR block, 5 CRs	Well-known	16	
53	Large CR block, 6 CRs	Well-known	19	

Type value	Name	Variant	Control element size	Description
54	Large CR block, 7 CRs	Well-known	22	
55	Large CR block, 8 CRs	Well-known	25	
56	Large CR block, 9 CRs	Well-known	28	
57	Large CR block, 10 CRs	Well-known	31	
58	Large CR block, 11 CRs	Well-known	34	
59	Large CR block, 12 CRs	Well-known	37	
60	Large CR block, 13 CRs	Well-known	40	
61	Large CR block, 14 CRs	Well-known	43	
-				
64	TRANSEC message #1	Custom	n	Refer to the security section in ETSI TS 101 545-1 [i.15]
65	TRANSEC message #2	Custom	n	Refer to the security section in ETSI TS 101 545-1 [i.15]
66	TRANSEC message #3	Custom	n	Refer to the security section in ETSI TS 101 545-1 [i.15]
67	TRANSEC message #4	Custom	n	Refer to the security section in ETSI TS 101 545-1 [i.15]
-127	Reserved/yet unknown	Unknown	n	
128 to 255	User defined	Custom	n	

- Padding start: Use of this type indicates that the rest of the control content is padding.
- No Operation: This is one byte that functions as padding.
- RCST status: This is one byte where the 2 least significant bits hold the same status as in the permanent header used in dedicated control bursts. The 4 most significant bits are implementation dependent and the 2 intermediate bits are reserved.
- RCST power headroom: This is one byte where the least significant 5 bits hold the power headroom similarly as reported in the permanent header used in burst in the dedicated control timeslots, but for the traffic burst holding the control PDU.
- RCST CNI and least margin transmission mode: This is two bytes that holds the same information as reported in the permanent header used in dedicated control bursts.
- RCST maximum power headroom: This is one byte that reports the maximum power control headroom relative to the maximum EIRP allowed for the transmission type used to transmit the control information. It is given in a resolution of 0,5 dB.
- EIRP dependency: An 8 bit field indicating the maximum EIRP dependency on change in carrier frequency in the most significant 4 bits and the maximum EIRP change upon change in modulation order in the least significant 4 bits, referring to operation with zero power headroom and coded as specified in table 8-14. A reserved value is to be interpreted as 0xF was sent.

Table 8-14: Coding of EIRP dependencies

Value	Frequency change	QPSK to 8PSK; QPSK to 16QAM
0x0	< 0,1 dB per 100 MHz	< 0,1 dB; < 0,1 dB
0x1	< 0,5 dB per 100 MHz	< 0,1 dB; < 0,5 dB
0x2	< 1 dB per 100 MHz	< 0,5 dB; < 1,0 dB
0x3	< 1,5 dB per 100 MHz	< 1,0 dB; < 1,5 dB
0x4	< 2 dB per 100 MHz	< 1,0 dB; < 2,0 dB
0x5	< 2,5 dB per 100 MHz	< 1,5 dB; < 2,5 dB
0x6	Reserved	< 2,0 dB; < 3,0 dB
0x7	Reserved	< 3,0 dB; < 3,5 dB
0x8 to 0xE	Reserved	Reserved
0xF	< 3 dB per 100 MHz	< 3 dB; < 4 dB

- CR block: This is a structured filled with one or more equally formed CR elements. The CR elements are of two types, small and large, as specified in table 8-15. Several capacity requests of the same type and with the same rc_index may be issued in the same control message. The values shall then be accrued to one capacity request for the corresponding combination of capacity category and rc_index.

Table 8-15: Format and syntax of the CR elements

CR type	MSB(s)			LSB
	Capacity Category	rc_index	Scale	Value
Small	2 bits	4 bits	2 bits	8 bits
Large	2 bits	12 bits	2 bits	8 bits

- Capacity category: This is a 2 bit field indicating the capacity category of the request as given in table 8-16.

Table 8-16: Solicited capacity categories with corresponding units

Capacity category value	Capacity category	unit			
		SC 0	SC 1	SC 2	SC 3
0	VBDC	Byte	8x	64x	512x
1	RBDC	Kbps	4x	16x	64x
2	AVBDC	Byte	8x	64x	512x
3	Reserved				

- rc_index: This is a 4-bit field for a large CR element and a 12-bit field for a small CR element. It indicates the request class for which the capacity request is being issued.
- Value: This 8-bit unsigned integer indicates the required payload in units specific for the capacity category scaled according to the scaling_factor.
- M_and_C_message: This is a 16 bit field used to transport M&C messages as given in table 8-17.

Table 8-17: M_and_C_Messages

M_and_C_Message value	Indication
0x0000	No Message
0x0001	Fine synchronization achieved
0x0002	Log-off indication
0x0003 - 0x7FFF	Reserved
0x8000 - 0xFFFF	Echo Reply

- Logoff Cause: The one byte content of the logoff cause is coded as shown in table 8-18.

Table 8-18: Logoff causes

Code	Logoff Cause
0	NCC initiated logoff
1	User initiated logoff
2	Other autonomous logoff
3	Logoff for traffic standby
4	Logoff due to time sync error
5	Logoff due to frequency error
6	Logoff due to internal error in unit
7	Transition to continuous carrier
8 to 127	Reserved
127 to 255	User defined

- Mobility Control: This message allows the RCST to communicate requests and status messages related to mobility management to the NCC. The format of this message is defined in table 8-19.

Table 8-19: Syntax of the Mobility_Control_Message field

Syntax	No. of bits		Information Mnemonic
	Reserved	Information	
Mobility_Control_Message () {			
Message_Type		3	uimsbf
if (Message_Type == 0 7) {			
Reserved		29	uimsbf
if (Message_Type == 1 2 3) {			
Reserved		1	bslbf
Current_beam_ID		16	uimsbf
Candidate_beam_ID_1		4	uimsbf
Candidate_beam_ID_2		4	uimsbf
Candidate_beam_ID_3		4	uimsbf
}			
if (Message_Type == 4) {			
Exclusion_Zone_Action_Request		3	uimsbf
Current_Beam_ID		16	uimsbf
Exclusion_Zone_ID		10	uimsbf
}			
if (Message_Type == 5) {			
max_cnr_rel	2	1	bslbf
max_cnr		8	uimsbf
Azimuth_Pointing_Error		6	tcimsbf
Elevation_Pointing_Error		6	tcimsbf
Orientation_Error		6	tcimsbf
}			
if (Message_Type == 6) {			
Position_Report_Valid		1	bslbf
Position_Report_Part		1	bslbf
Position_Report_Sequence_Number	1	3	uimsbf
if (Position_Report_Part == 0) {			
Position_Latitude	1	18	tcimsbf
Altitude_Base		4	uimsbf
}			
else {			
Position_Longitude		19	tcimsbf
Altitude_Extension		4	uimsbf
}			
}			
}			

Semantics for Mobility_Control_Message:

- Message_Type: This 3-bit sub-field defines the type of message conveyed, as defined in table 8-20;

Table 8-20: Mobility message type

Message Type	Value
No message	000
Forward and return link handover request	001
Forward link handover request	010
Return link handover request	011
Exclusion zone entry	100
Transmitter status report	101
Position report	110
Reserved	111

- Current_Beam_ID: This 16-bit sub-field identifies the beam number of the satellite carrying the link for which the handover is requested. When Message_Type==1, this field identifies a beam used for both forward and return link;

- Candidate_Beam_ID_1: This 4-bit sub-field identifies the first-choice candidate handover destination beam relative to the current beam. A value of "1111" indicates that no first-choice candidate has been identified;
- Candidate_Beam_ID_2: This 4-bit sub-field identifies the second-choice candidate handover destination beam relative to the current beam. A value of "1111" indicates that no second-choice candidate has been identified;
- Candidate_Beam_ID_3: This 4-bit sub-field identifies the third-choice candidate handover destination beam relative to the current beam. A value of "1111" indicates that no third-choice candidate has been identified;
- Exclusion_Zone_Action_Request: This 3-bit sub-field indicates the action requested by the RCST upon entering the exclusion zone, as defined in table 8-21;

Table 8-21: Exclusion zone action request

Action Requested	Value
cNo specific request	000
Log off	001
Change frequency	010
Adapt Transmission Parameters	011
Reserved	100 to 111
NOTE: The "Adapt Transmission Parameters" request can entail any combination of changes to power, data rate, coding scheme and spreading factor deemed appropriate by the NCC.	

- Exclusion_Zone_ID: This 10-bit sub-field identifies the exclusion zone, relative to the current return link beam, that the RCST is about to enter;
- max_cnr_rel: This 1-bit sub-field indicates whether the max_cnr field is to be interpreted as an absolute value or relative to a system-dependent reference condition. A value of '1' indicates a relative value;
- max_cnr: This 8-bit sub-field indicates the maximum allowed C/N at the demodulator, referred to a symbol / chip rate bandwidth. A value of x dB is coded as $120 + x/5$. If max_cnr_rel ==1, the value is interpreted as a change relative to a system-dependent reference condition;
- Azimuth_Pointing_Error: This 6-bit sub-field indicates the current antenna pointing offset from the current return link satellite along the geostationary arc, in units of 0,1 degree. Pointing to the east of the satellite shall be indicated as a positive number. The value 0x20 shall represent an undetermined pointing error. The value shall saturate for error magnitudes in excess of 3,1 degrees;
- Elevation_Pointing_Error: This 6-bit sub-field indicates the current antenna pointing offset from the current return link satellite perpendicular to the geostationary arc, in units of 0,1 degree. Pointing to the north of the satellite shall be indicated as a positive number. The value 0x20 shall represent an undetermined pointing error. The value shall saturate for error magnitudes in excess of 3,1 degrees;
- Orientation_Error: This 6-bit sub-field indicates the current return link antenna pattern rotation from its nominal orientation with its long axis parallel to the geostationary arc, in units of 0,5 degrees. Counter-clockwise rotation as seen from the RCST shall be indicated as a positive number. The value 0x20 shall represent an undetermined orientation error. The value shall saturate for error magnitudes in excess of 15,5 degrees;
- Position_Report_Valid: This 1-bit sub-field indicates whether the position report is valid. It is set to "1" if the report is valid and to "0" otherwise;

NOTE 1: This flag can also be used to indicate a refusal to provide a position report, for example for security reasons.

- Position_Report_Part: This 1-bit sub-field indicates which of the two parts of the position report defined in the table is being transmitted. A complete position report consists of both parts, each transmitted in one Mobility_Control_Message;

- Position_Report_Sequence Number: This 3-bit sub-field holds a sequence number of the position report. The sequence number should be incremented for each transmitted report and wrap to 0 when the maximum value is reached. The sequence number shall be the same for each of the two parts of a position report;
- Position_Latitude: This 18-bit sub-field indicates the current latitude of the terminal in the WGS84 [i.18] datum, in units of 0,001 degrees. Northern latitudes shall be stated as a positive number, southern latitudes as negative;
- Altitude_Base: This 4-bit sub-field indicates the terminal's altitude above the WGS84 [i.18] reference surface, in units of 1 600 m. Altitudes below the reference surface shall be indicated as 0;
- Position_Longitude: This 19-bit sub-field indicates the current longitude of the terminal in the WGS84 [i.18] datum, in units of 0,001 degrees. Eastern longitudes shall be stated as a positive number, western longitudes as negative;
- Altitude_Extension: This 4-bit sub-field indicates the terminal's altitude above the value provided in Altitude_Base, in units of 100 m. Altitudes below the WGS84 [i.18] reference surface shall be indicated as 0;

NOTE 2: The overall reported altitude is $100 \times (16 \times \text{Altitude_Base} + \text{Altitude_Extension})$.

- Continuous Carrier Control Message: This message allows the RCST to communicate carrier requests and status messages related to continuous-carrier operation to the NCC. The format of this message is defined in table 8-22.

Table 8-22: Continuous carrier control message

Syntax	No. of bits		Information Mnemonic
	Reserved	Information	
Continuous_carrier_control_message() {			
message_type		8	uimsbf
if ((message_type == 1) (message_type == 2) (message_type == 4)) {			
frame_type_request	8	8	uimsbf
tx_type_request		8	uimsbf
}			
if ((message_type == 3) (message_type == 5) (message_type == 7)) {			
Reserved	24		
}			
if ((message_type == 6) (message_type == 0x0B)) {			
reason_code	16	8	uimsbf
}			
if (message_type == 8) {			
accrued_timing_offset	4	20	tcimsbf
}			
if (message_type == 9) {			
accrued_frequency_offset	4	20	tcimsbf
}			
if (message_type == 0x0A) {			
countdown_value	12	4	uimsbf
next_tx_type		8	uimsbf
}			
}			
NOTE:	Reserved bits are of type bslbf, and shall precede the Information bits on the same line. They shall be ignored by the RCST. For an encrypted uni-cast TIM, the bit values shall be varied in a random manner to avoid encryption spoofing.		

Semantics for the Continuous_carrier_control_message:

- message_type: This 8-bit field defines the type of message contained in the information element, in accordance with table 8-23;

Table 8-23: Continuous carrier control message types

Value	Message
0x00	Reserved
0x01	Non-persistent carrier assignment request
0x02	Persistent carrier assignment request
0x03	Carrier release request (returning to TDMA)
0x04	Carrier replace request (preserve mode)
0x05	Receiver acquisition acknowledgement request
0x06	Persistent CC mode entry acknowledgement/rejection
0x07	Persistent CC mode carrier revocation acknowledgement
0x08	Accrued timing offset report
0x09	Accrued frequency offset report
0x0A	Countdown to tx_type change
0x0B	Mode configuration acknowledgement/rejection
0x0C-0x7F	Reserved
0x80 to 0xFF	User defined

- frame_type_request: This 8-bit field identifies the type (by frame_id value) of carrier requested;
- tx_type_request: This 8-bit field identifies the MODCOD (by tx_type value) requested used on the carrier type requested;
- reason_code: This 8-bit field reports the status and, if applicable, reason for the RCST to reject switching to persistent continuous-carrier mode. The values are defined in table 8-24;

Table 8-24: Continuous carrier reason codes

Value	Message
0x00	Reserved
0x01	Success; persistent CC mode entered
0x02	Failure, carrier properties not supported
0x03 to 0x7D	Reserved
0x7E	Success, general purpose
0x7F	Failure, unknown reason
0x80 to 0xFF	User defined

- accrued_timing_offset: This 20-bit signed-value field reports the sum of timing corrections received since the last time a correction was applied. The value is reported in NCR ticks as a two's complement signed integer (not in base/extension format). If the RCST does not accumulate this offset, or if the accumulated offset exceeds the range that can be represented, the value 0xFFFF shall be used;
- accrued_frequency_offset: This 20-bit signed-value field reports the sum of frequency corrections received since the last time a correction was applied. The value is reported in 10 Hz steps as a two's complement signed integer. If the RCST does not accumulate this offset, or if the accumulated offset exceeds the range that can be represented, the value 0xFFFF shall be used;
- countdown_value: This 4-bit field indicates the number of subsequent carrier frames, not including the one in which the message is carried, which will be transmitted using the current tx_type. After this number of subsequent frames, the tx_type will be switched to the value indicated by the next_tx_type field;
- next_tx_type: This 8 bit field indicates the tx_type that will be used after the switch;
- RCST DVB-S2X CNI and least margin transmission mode: This is three bytes that contain the dvbs2x_CNI_and_least_margin_transmission_mode from table 8-11 that is also present in the permanent header used in dedicated control bursts.

- RCST DVB-S2X Annex E support: Two bytes field wherein:
 - First byte: Bit i , $i=0, \dots, 7$, bit 0 is the MSB and bit 7 is the LSB signifies that Superframe Format i is supported;
 - Second byte is reserved_zero_for_future_use.
- TRANSEC message: The TRANSEC messages are reserved for use by an implementation dependent TRANSEC system; refer to the security section in ETSI TS 101 545-1 [i.15].

8.3.3 CSC Burst Issued by RCST

Table 8-25 shows the content of a CSC burst that complies with ETSI EN 301 790 [1] and that is intended to instruct the NCC about the capabilities for the unit to switch to operate according to the present document instead of operating according to ETSI EN 301 790 [1].

Table 8-25: CSC burst complying with ETSI EN 301 790 [1] issued by NG terminal

Field	No. of bits	Information Mnemonic
RCST_CSC_payload() {		
RCST capability "A" () {		
Security mechanism	1	bslbf
SNMP	1	bslbf
ATM connectivity	1	bslbf
MPEG2-TS TRF	1	bslbf
RCST boards	2	uimsbf
RCST ACQ	1	bslbf
Multi_IDU	1	bslbf
}		
SW Version	8	uimsbf
Freq Hopping Range	2	uimsbf
MF-TDMA	1	bslbf
RCST Class	2	bslbf
Route_ID capable	1	"0"
RCST Mode	2	"3"
RCST MAC address	48	uimsbf
CSC_Route_ID	16	bslbf
RCST capability "B" () {		
Dynamic connectivity	1	
Frequency Hopping	1	
DVB-S capability	1	
DVB-S2 capability	2	
}		
RCST protocol version	2	uimsbf
RCST capability "C" () {		
Route_ID_overload	1	"0"
Mobility Support	3	bslbf
Continuous ACM	1	bslbf
NLOS countermeasure support	1	bslbf
Transparent mesh reception support	2	bslbf
}		
More_lower_layer_capability	8	bslbf
Burst type identifier	1	"1"
If_CRC_on_CSC_burst {		
CRC-16	16	rpchof
}		
}		

RCST mode '3' is used to indicate an NG terminal attempting to enter through the network compliant to ETSI EN 301 790 [1] to get into NG operation by using the CSC burst specified in ETSI EN 301 790 [1].

'Route ID' bits shall contain the 2 MSBs of the 3 byte lower layer capability map specified in table 8-5. The parameter more_lower_layer_capability shall hold the 3rd byte of the capability map.

RCST protocol version '0' is used to indicate that the NG terminal is not capable of issuing other ETSI EN 301 790 [1] bursts than the logon burst with content as specified in table 8-17. This value also indicates that other information in the logon burst specific to ETSI EN 301 790 [1] operation may be irrelevant and should be ignored by the NCC. The NG terminal could provide the most relevant values in the different fields, corresponding to the specification in ETSI EN 301 790 [1].

8.3.4 Transmission of Return Link L2S Data Structures

The term "bit 0" refers to the least significant bit of a multi-bit field. The most significant bit of a k-bit unsigned value field is designated "bit k - 1". For a signed value field, "bit k - 1" is the sign bit and "bit k - 2" the most significant magnitude-related bit.

A top level L2S data structure aggregate shall be transmitted as an SDU in the lower layers in payloads dedicated to the content type applicable for the specific data structure, with the following internal order:

- 1) Fixed fields in a data structure shall be transmitted in the order they are listed, from top to bottom.
- 2) A contiguous sequence of fields as an iteration of a field type shall be transmitted in the order of iteration.
- 3) Relocatable fields in a flexible data structure may be transmitted in any order if not explicitly stated otherwise.
- 4) Reserved bits associated to a field shall be transmitted before the information bits of the same field.
- 5) Multi-bit fields shall be transmitted in bit order starting with the bit considered most significant and ending with the bit considered least significant.

9 M&C Functions Supported by L2S

9.0 Introduction

This clause defines the procedures and control messages that support an RCST in connecting to the satellite interactive network and staying connected to the network. It also specifies the management and control support.

There are also generic requirements that apply regionally. As an example of generic requirements the RCST shall comply with the Control and Monitoring Functions (CMF) specified in ETSI EN 301 459 [5] in the applicable regions. Among other requirements, it is here required that the RCST is not allowed to transmit, when it does not receive its control correctly.

The M&C functions are operated in domains delimited by the following identifiers, each item applicable as explicitly specified for each function:

- 1) Start-up downlink TDM as administratively configured and selected by the RCST.
- 2) Operational Population ID as administratively configured for the RCST.
- 3) Original Network ID as indicated by the NIT.
- 4) Interactive Network ID as indicated by the RMT.
- 5) Network Control Centre ID as indicated by the Forward Link descriptor.
- 6) Satellite ID as indicated by the Forward Link descriptor and by the Return Link descriptor.
- 7) Beam ID as indicated by the Forward Link descriptor and by the Return Link descriptor.
- 8) Gateway ID as indicated by the Return Link Descriptor.
- 9) Local Link ID as specified by the Forward Link Descriptor.

In systems that support the SAT (see 6.4.7.2) additional information is (optionally) provided, as described in section 9.1.1.

9.1 Connecting the Forward Link

9.1.0 Introduction

This clause specifies the network acquisition procedure to be used by the RCST.

9.1.1 Acquisition of the Forward Link Signalling

Service Information for Forward Link Signalling (FLS) may be transmitted in a single multiplex or over several multiplexes. If the interactive service on a forward link stream is announced by use of the SDT (see ETSI EN 300 468 [3]), the `service_type` in the SDT shall be set to indicate "RCS FLS" (to 0x0F according to ETSI EN 300 468 [3]). An RCST may or may not recognize the SDT.

A Population ID may be used to identify a subset of the RCSTs sharing a start-up TDM. In the simplest case, an NCC handles a single interactive network. An NCC may however logically split its capacity into several interactive networks.

The RCST shall tune to the start-up TDM and the stream configured in advance, and shall fetch the NIT to locate the TDM and identify the stream carrying the RMT. The RMT location shall be identified by locating the linkage descriptor containing the `linkage_type` code identifying the RCS Map service, with a `linkage_type` code specified by ETSI EN 300 468 [3] (0x07). The RCST shall use the `forward_multiplex` value from that Linkage Descriptor to locate the Satellite Delivery System Descriptor for that stream (found in the transport section of the same NIT) and fetch the tuning details for the TDM and identify the stream carrying the RMT.

The RCST shall then re-tune (if necessary) to the TDM and stream that carries the RMT and shall load the RMT. The RMT shall contain one or more Linkage Descriptors each identifying and locating one FLS service, identified by the `linkage_type` code 0x81 (the one also used by ETSI EN 301 790 [1]) or the `linkage_type` code 0x82 (specific for linkage to a continuous generic stream). An RCST that does not support operation on a TS Packet based stream shall discard Linkage Descriptors with the `linkage_type` code 0x81. Each Linkage Descriptor is associated to one or more Population IDs. The RCST shall scan the RMT for all applicable FLS service Linkage Descriptors to find a descriptor matching its Population ID. For this purpose the RCST may initially use a default Population ID for the installation process. The Population ID used by the RCST may be administratively changed at a later stage and memorized for following network logons.

The RCST shall then locate the entry for that `forward_multiplex` and `return_multiplex` combination in the second loop of the RCS Map Table and extract the Satellite Forward Link Descriptors and the Satellite Return Link Descriptors. Where there are multiple instances of these, the RCST shall extract the signalling satellite forward link and one satellite return link multiplex as a minimum, and use these for the balance of the acquisition procedure. RCSTs capable of connecting to only one forward link TDM at a time shall accept the combined signalling/data type forward link TDM as identified in the Satellite Forward Link Descriptor and shall ignore forward link TDMs allocated for other types of use.

These descriptors contain initial parameters required by the subsequent logon process, namely the `satellite_id` for both forward and return links, the `gateway_id` for the return link, the `NCC_id` of the NCC to logon to, and the identification of the `superframe_sequence` to be used for logon.

The RCST shall then again re-tune (if necessary) to the TDM carrying its forward link signalling, using the parameters defined in the Satellite Forward Link Descriptor referring to the signalling for its Population ID.

The result of this forward link identification and location procedure shall be the following:

- Identification of the NCC and satellite for the Forward Link Signalling service.
- Identification of the Gateway and satellite for the return link.
- Identification of the superframe sequence to be used for the return link logon procedure.

After the last retuning, the RCST shall load the following tables and information from the FLS carrying the signalling:

- NCR to align with the return link TDMA structure.
- SCT and FCT2 to identify the structure of the superframes and the frames.
- BCT to identify the available transmission types.

- SPT or SAT to obtain the satellite ephemeris data and additional satellite system information for the forward link signalling satellite and return link satellite.
- TIM-B to identify system specific aspects encoded by the broadcast descriptors.
- TBTP2 to identify random access logon timeslots dynamically made available for logon requests, and any dedicated access logon timeslots.

The start-up TDM might be carried over a continuous or bursty channel (a beam-hopping channel), and it may optionally carry a SAT table (see 6.4.7.2). The SAT provides an RCST that supports it with the following information:

- A time association Info table that associates the time of day with the NCR reading of the start-up downlink satellite, down to a nanosecond resolution.
- A cell-fragment Info table that enables the RCST, based on its geographical location, identify the active satellite delivery systems that are currently available in its location.
- A beam-hopping time plan information which enables the RCST to manage its activity time and assists it in acquiring the satellite delivery system allocated to it.

The `satellite_forward_link_v2_descriptor`, received as part of the RMT or TIM-U messages provides the physical layer parameters required for receiving the forward link, the `satellite_id` of the satellite carrying it (in case of a multiple satellites system) and the associated beam-hopping time plan.

9.1.2 Acquisition of Multiple Forward Link Streams (optional)

An RCST that supports multiple forward link streams on a shared TDM may be assigned additional data-only streams via the Forward Link Streams Descriptor in the logon response TIM-U when connecting the return link. This descriptor shall be interpreted exclusively so reception of a new descriptor supersedes a previously received descriptor.

9.1.3 Acquisition of Multiple Forward Link TDMs (optional)

An RCST that supports concurrent reception of multiple forward link TDMs may be assigned forward link TDMs allocated to different usage by the Satellite Forward Link Descriptor. Three different usages are defined for a forward link stream, as shown in table 9-1.

Table 9-1: Forward Link Usage

Forward Link Usage
Combined signalling/data
Signalling only
Data only

The first two variants are mutually exclusive in any multiple forward link TDM set-ups (there can only be one signalling stream set-up for a given Population ID). The signalling-only variant can only be used where all RCSTs covered by that forward link are capable of receiving multiple forward link TDMs.

A previously assigned data-only forward link TDM stream may be released, without logging off the terminal.

For RCSTs that can operate on multiple forward links simultaneously, there are two possible methods for allocating additional forward links:

- Dedicated assignment when connecting the return link. The RMT provides the signalling-only forward link, and the TIM-U provides data-only forward links.
- Broadcast assignment. The RMT uses multiple descriptors, one for each forward link defined. Only one of these may be a signalling-multiplex-only forward link.

For both modes, the TIM-U can command changes to the initial configuration defined via the RMT by the Satellite Forward Link Descriptor. Changing the signalling multiplex may cause service interruption.

9.2 Connecting the Return Link

9.2.0 Introduction

This clause defines the procedures to support an RCST in connecting to the satellite interactive network, stay connected and disconnect, and being disconnected from the network.

Additional provisions for the optional continuous carrier access method are provided in clause 9.2.8.

The period of having a non-interrupted connection to the interactive network is called a Logon Session.

9.2.1 Return Link States and State Transitions

For an RCST the return link can be in one of the following *states*, illustrated in figure 9-1.

Off/Standby: This is the normal state immediately following power-on initialization, as well as a default state to which the RCST returns in some situations following loss of synchronization or upon being logged off. It is an implementation choice whether this state is absorbing; i.e. whether any external stimulus is required in order to initiate the processes that may cause a transition away from this state. The forward link shall be kept operational in this state. When entering the Off/Standby state, the RCST shall immediately cease transmission. It may keep dynamic identifiers if specifically allowed to do so as indicated for the assignment. The RCST shall not transmit while in the Off/Standby state.

Hold/Standby: When entering the Hold/Standby state, the RCST shall immediately cease transmission. It may keep dynamic identifiers if specifically allowed to do so as indicated for the assignment. An RCST in the Hold/Standby state shall remain there following restart and power cycling events until the NCC releases the condition(s) that keep the RCST in the Hold/Standby state. The forward link shall be kept operational in this state. The RCST shall not transmit while in the Hold/Standby state.

Ready for Logon: The RCST enters this state when the forward link has been successfully acquired and the configuration data required for issuing logon is up to date. It is an implementation choice whether this state is absorbing; i.e. whether any external stimulus is required in order to initiate the processes that may cause a transition away from this state. External triggers may include for example arrival of data on the terrestrial interface or reception of a "wake-up" message in the TIM-U. Transmission of logon bursts is allowed when the RCST is in this state.

Ready for TDMA Sync: The RCST is in this state when the lower layer logon procedure has been completed successfully but TDMA synchronization has not yet been achieved. This is a non-absorbing state; the RCST shall autonomously transition to another state. Transmission of control bursts is allowed when the RCST is in this state.

TDMA Sync: This is the normal operational state for the RCST. This is an absorbing state; the RCST shall remain there until external events or loss of TDMA synchronization dictate transition to another state. The TDMA synchronization status shall be supervised by the Sync Monitoring Process. Transmission of control bursts is allowed when the RCST is in this state. Transmission of traffic burst and traffic/control bursts may be allowed or these may be dynamically blocked even if assigned.

NCR Recovery: The RCST enters this state when there is loss of TDMA synchronization or NCR loss when in TDMA Sync. This is a non-absorbing state; the RCST shall autonomously transition to another state. The RCST shall not transmit while in the NCR Recovery state.

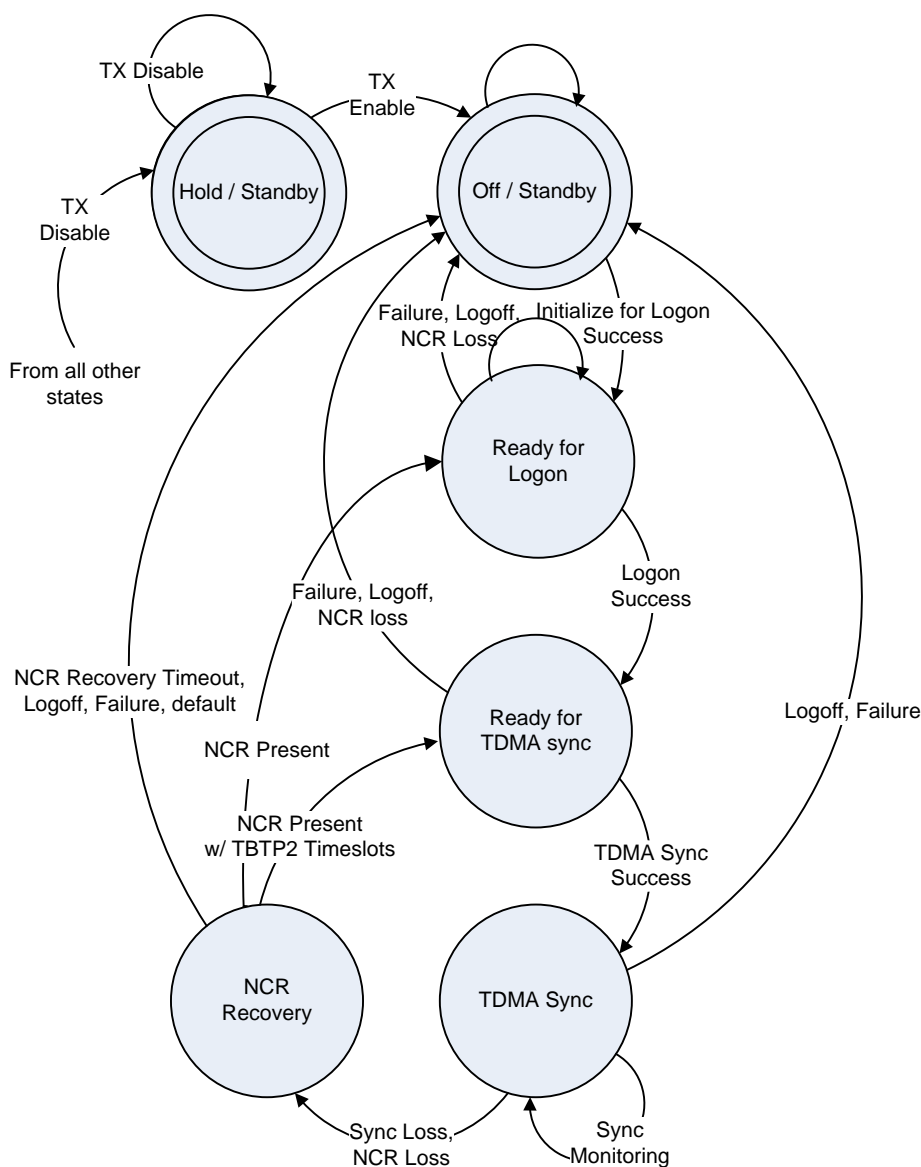

Figure 9-1: RCST State Diagram for MF-TDMA Operation

In order to be able to logon to the interactive network, the RCST shall first connect to the forward link as described in clause 9.1 and it shall have successfully completed the procedure described in clause 9.2.2.

The RCST lower layers establish and maintain the connection to the interactive network through four main procedures/processes:

Lower layer logon procedure: The RCST requests return link physical layer synchronization support and access to the interactive network, and information required in proceeding connecting to the interactive network (or alternatively the request may be rejected or ignored by the interactive network). See clause 9.2.3.

TDMA synchronization procedure: The RCST establishes return link physical layer synchronization. See clause 9.2.5.

Synchronization monitoring process: The RCST supervises its return link physical layer synchronization. See clause 9.2.6.

Logoff procedure: The logoff procedure described in clause 9.2.7 applies when the RCST terminates the TDMA synchronization with the network. The RCST will keep the forward link connection.

An RCST which receives a TIM-U with the Transmit_Disable flag set to '1' shall immediately enter the Hold/Standby state and shall remain there until it receives a TIM-U where the Transmit_Disable flag is set to '0'. This may happen in any state. The same behaviour applies for the link failure and NCC failure conditions indicated in TIM-B as specified in clause 9.12.7.

An RCST which receives a TIM-U with the Log_Off flag set to '1' shall immediately enter the Off/Standby state, if not in the Hold/Standby state. The policy that the RCST uses for deciding when to attempt to log on again is implementation dependent.

The RCST shall monitor the NCR reception throughout the logon session, regardless of the return link state. In the event that NCR reception is interrupted for a period causing the NCR to be considered lost, the RCST shall cease transmission and proceed in one of the two standby states, except as specified for the TDMA Sync state and the NCR Recovery state. Similarly, other types of failure may take the RCST to a standby state. The maximum duration of NCR interruption without considering the NCR lost is implementation dependent.

The RCST shall execute the Initialize Logon Procedure to transition from the Off/Standby state to the Ready for Logon state. It may not enter the Ready for Logon state until this procedure has been completed successfully. Upon Initialize Logon success, the RCST shall enter the Ready for Logon state. The RCST may decide to move from the Ready for Logon state e.g. because it is booting up or because it wants to transmit data and has logged off after a long period of inactivity. Alternatively, the NCC may provoke the logon procedure by sending a "Wake up" signal to the RCST in a TIM-U as described in clause 9.12.3. The RCST shall execute the Lower Layer Logon Procedure to reach the Ready for TDMA Sync state. Upon Lower Layer Logon success, the RCST shall proceed to the Ready for TDMA Sync state. If the logon procedure is unsuccessful, the RCST shall proceed to the Off/Standby state.

In the Ready for TDMA Sync state, the RCST shall autonomously proceed with the TDMA Synchronization Procedure. If TDMA synch is achieved, the RCST shall proceed to the TDMA Sync state. If TDMA synch is not achieved, the RCST shall proceed to the Off/Standby state.

In the TDMA Sync state, the Synchronization Monitoring Process monitors the TDMA synchronization status. The RCST remains in the TDMA Sync state until either of the following events occurs:

- If there is loss of TDMA synchronization, the RCST shall proceed to the NCR Recovery state.
- If a TIM-U with a Logoff command is received, the RCST shall execute the Logoff Procedure and proceed to the Off/Standby state.
- If a TIM-U with a TX Disable instruction or a TIM-B with a link/network failure indication is received, the RCST shall proceed to the Hold/Standby state.
- If the NCR is lost, the RCST shall proceed to the NCR Recovery state.

The RCST shall cease transmission when leaving the TDMA Sync state.

The RCST may unconditionally transition to the Off/Standby state from the NCR Recovery state, independent of the NCR Recovery timeout. While in the NCR Recovery state, the RCST shall monitor the NCR reception. If the NCR is fully recovered before the NCR Recovery timeout, the RCST may either proceed to the Ready for TDMA Sync state if the TBTP2 supplies a dedicated timeslot for control burst, or the RCST may proceed to the Ready for Logon state. If the NCR recovery timeout occurs, the RCST shall proceed to the Off/Standby state. The NCR Recovery timeout shall default to zero, it may be administratively configured to a different value and it may for a mobile terminal be under NCC control via the Mobility Control Descriptor in the TIM-U.

The RCST may stay in the TDMA Sync state also if administratively blocked from issuing anything but logon bursts and control bursts, indicated by the "Scheduler failure" flag in TIM-B. It is an implementation choice if such blocking is treated similarly as a TX Disable with transition to the Hold/Standby state causing all transmission to cease.

An example of the exchanges during normal progression from initial power-on to the fully operational TDMA Sync state is illustrated in figure 9-2. The sequence illustrates the normal flow of events and signals where the fine synchronization procedure is used.

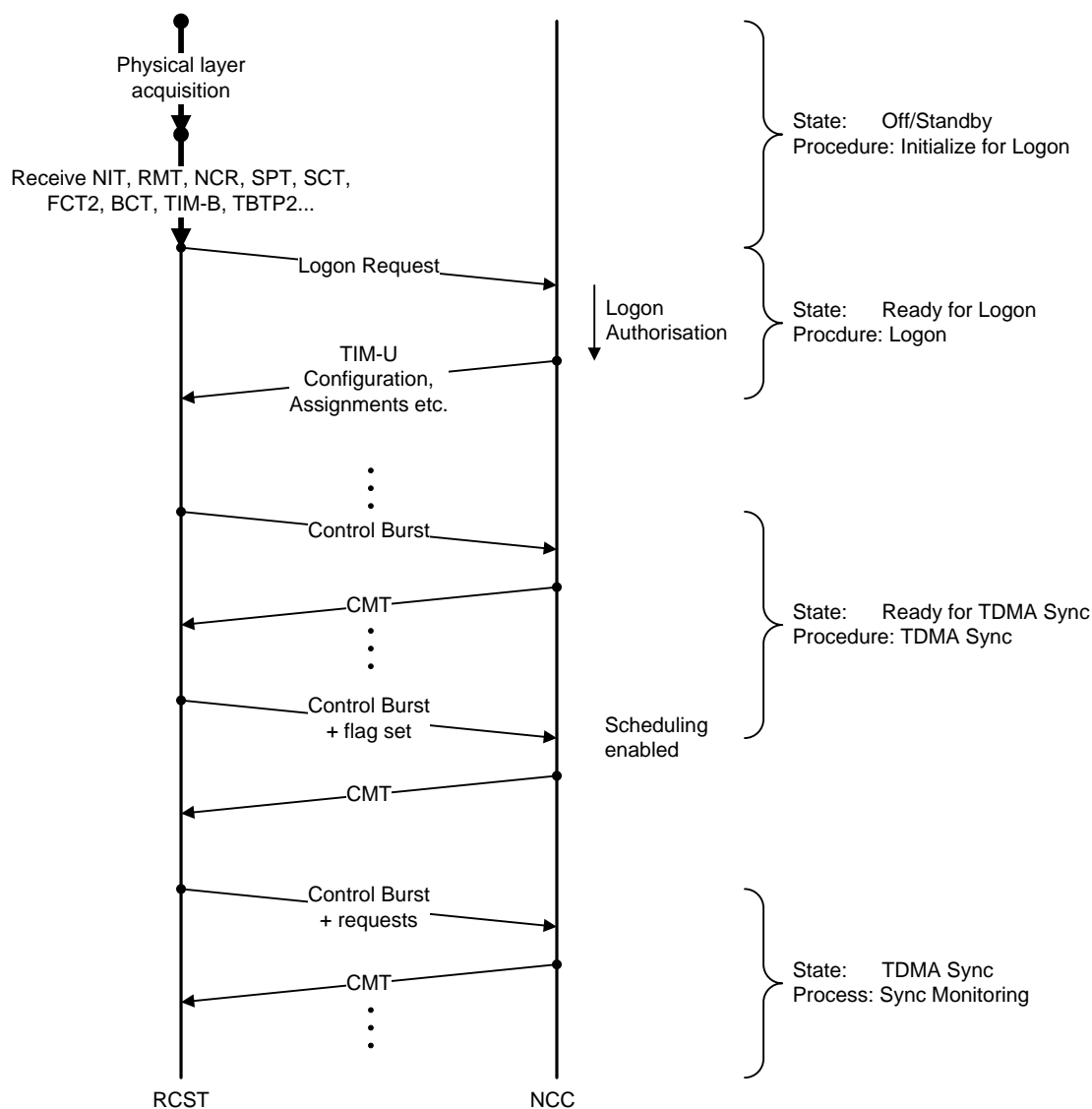

Figure 9-2: Example of Interactive Network Lower Layer Signalling Flow on the FL, the SFS to be Used for Logon and the SFS to be Used for Operation

9.2.2 Initialize for Logon Procedure

The RCST shall follow the procedures described in clause 9.1 to find all necessary control information related to the operation of the RCS network. This includes NCR synchronization, through which the RCST initiates its internal clock, by tracking the NCR which is transmitted by the NCC on the forward link.

The RCST shall receive the BTP transmitted by the NCC at regular intervals. The BTP structure is contained in the Forward link Signalling, and is made up of the SCT, the FCT2, the BCT and the TBTP2. The RCST shall also acquire the TIM-B in conjunction with this.

The RCST shall read the Lowest Software Version descriptor matching the OUI of its RCST HID, if this information is present in TIM-B. The RCST shall proceed to log on if its current operational SW version as defined by implementation specific rules is considered sufficient to do so. If the current operational SW version is insufficient, the RCST shall not log on but the RCST may instead take the necessary measures e.g. to automatically load or acquire another operational SW version and then proceed with logon. The Lowest Software Version descriptor may contain a reference to an IPv4 multicast stream that may provide the required SW by a software download service.

After having completed these steps successfully, the RCST may enter the Ready for Logon state.

9.2.3 Lower Layer Logon Procedure

9.2.3.0 Introduction

The RCST shall issue logon bursts with timing advance as specified in clause 7.3.9. Two variants of the logon procedure exist, the basic procedure and a procedure extension called *Logon at Large Timing Uncertainty*. Logon timeslots may be assigned by SCT and FCT2, and by these in combination with a TBTP2 specific for logon timeslots.

9.2.3.1 Basic Logon Procedure

The RCST shall search the BTP for logon timeslots that it may use, as provided by the SCT, FCT2, BCT and TBTP2. The RCST shall send a logon request in a logon timeslot, either using random access or a logon timeslot dedicated to the RCST, with precedence to the latter if this is provided. The request shall contain as a minimum:

- An indication of the type of logon that is requested
- An indication of the networking status of the RCST as it perceives it
- The RCST HID (concerns only random access, not used in the dedicated access timeslot logon burst)
- A field indicating the lower layer capabilities of the RCST

The RCST may timeout waiting for a response to a logon burst. The RCST shall then transmit again a logon burst in a dedicated logon timeslot if this is available and the maximum allowed logon burst transmissions has not been exceeded. The RCST shall transmit this logon burst by random access if a dedicated logon timeslot is not available. This is according to the procedure shown in figure 9-3. Repeated transmission by random access shall employ random access load control as specified in clause 9.7.1. If a logon accept has not been received before the RCST has timed out waiting for a response to the last logon burst the RCST is allowed to send, the logon procedure shall terminate with failure.

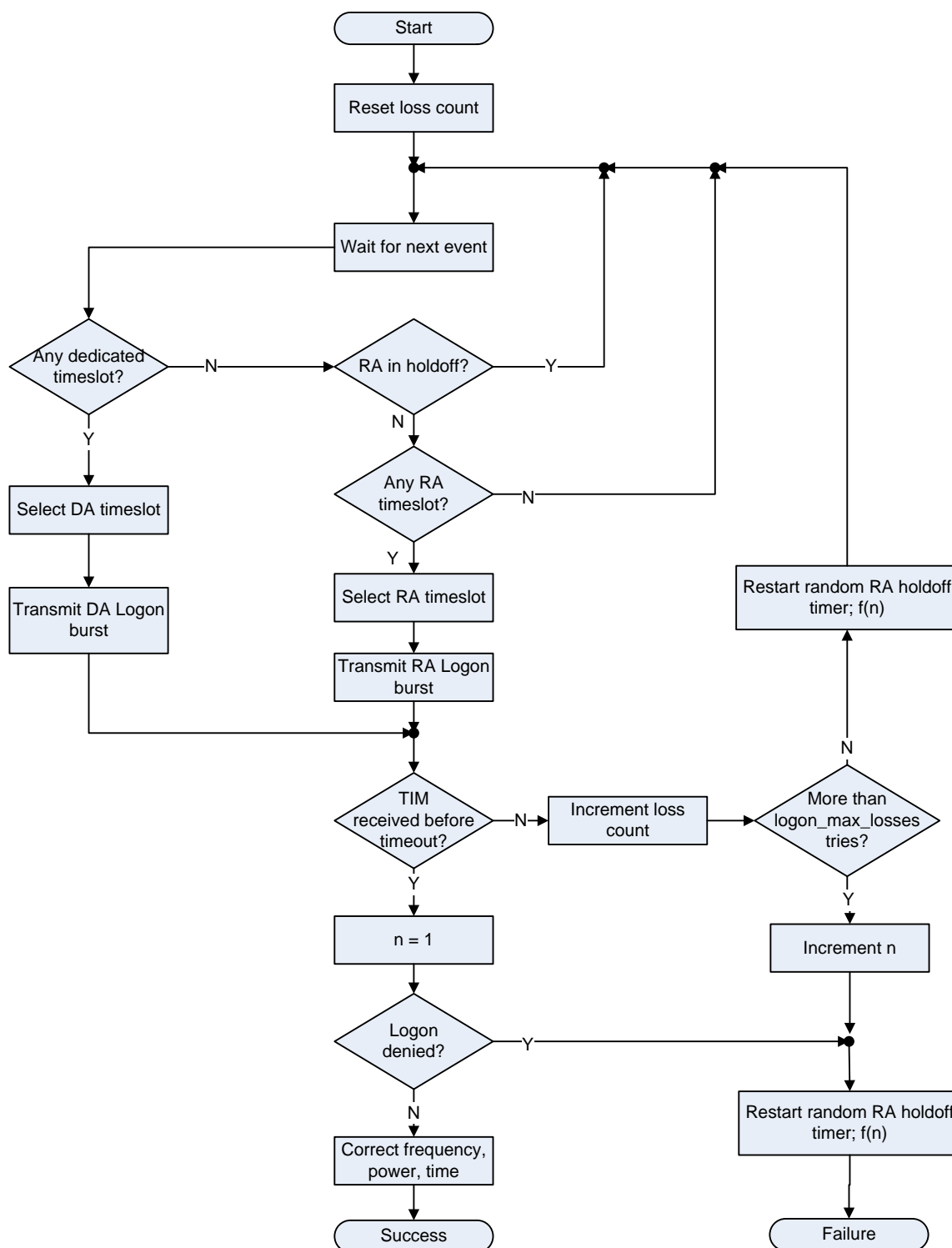

Figure 9-3: Lower Layer Logon Procedure

When the logon procedure fails, the RCST shall not issue an RA logon request again before a hold-off interval according to the rules for the randomized RA hold-off for the procedure has elapsed, as indicated in figure 9-3.

The NCC decides whether to allow the RCST to logon. The criteria for this decision are outside the scope of the present document; they may for example include checks that transmission resources are available and that administrative aspects are satisfied (e.g. account is valid, account is paid, etc.).

The NCC may send a TIM-U to the RCST to reject the logon request. The RCST shall when receiving such response immediately terminate the lower layer logon procedure with failure.

The NCC may send a TIM-U to the RCST as an acknowledgement to the logon request. This TIM-U shall at least contain the following descriptors:

- The Logon Response Descriptor, initializing the RCST for operation in the network.
- The Control Assign Descriptor, indicating the TDMA synch thresholds and a pattern of dedicated access control timeslots.
- The Correction Message Descriptor, indicating initial corrections in timing, frequency and power relative to the transmission of the logon request burst in the timeslot where it was received.
- The Lower Layer Service Descriptor.

Upper limits for logon repetition rate and duration of the logon request that may apply for a specific system are specified in certain regulatory documents applicable to specific frequency bands, geographical regions and type of RCST (e.g. ETSI EN 301 459 [5], ETSI EN 302 186 [i.22], ETSI EN 302 340 [i.23], ETSI EN 302 448 [i.24], ETSI EN 302 977 [i.25] and ETSI EN 303 978 [i.28]).

9.2.3.2 Logon via Dynamically Allocated Logon Timeslots

The NCC may provide dedicated assignment logon timeslots by reference to the RCST HID in the TBTP2. Random access logon timeslots may be dynamically allocated using the 8 bit Assignment ID format in the TBTP2. That suffices to indicate the specific access method.

The RCST that is pending for logon to the interactive network shall scan TBTP2 issued specifically for the logon context. The NCC shall use a TBTP2 indicated to be dedicated to the logon context to issue any dynamically assigned logon timeslots. A TBTP2 may indicate dedicated assignments or allocation of timeslots for random access logon. The RCST shall unconditionally use an available dedicated assignment of a logon timeslot when pending for transmission of logon. The RCST shall incorporate dynamically allocated random access logon timeslots in the randomized timeslot selection process.

For the logon timeslots, the `superframe_count` value in the TBTP2 refers to the first superframe with this `superframe_count` that starts later than the logon response waiting time later than the time of arrival of the TBTP2. The value of the `Logon_response_timeout` is indicated by the Logon Contention Descriptor sent in TIM-B.

9.2.3.3 Logon with Support for Large Timing Uncertainty

The provisions in this clause may be used to allow logon in situations where the RCST-to-satellite delay is not known with an accuracy that is sufficient to ensure that the logon burst can be transmitted such that it is received within the boundaries of a single logon timeslot. To support this, the NCC may use a consecutive sequence of adjacent logon timeslots in combination with the Correction Message Extension descriptor in the logon response TIM-U to identify the timeslot in which the logon burst actually was received. When computing the timing correction, the RCST shall then combine the experienced offset in the timeslot grid with the instructed correction relative to the timeslot where the logon request was received. The timeslot where the logon request was received is indicated in the supplemental Correction Message Extension.

Support for this optional feature shall be indicated in the forward link signalling by setting the Large Timing Uncertainty Flag for the SFS in the Superframe Composition Table to "0". An RCST requiring this method shall not attempt to logon unless this support is thus signalled. When this support is indicated the NCC shall respond with the Correction Message Extension descriptor in the logon response TIM-U following the logon request in the associated SFS.

When using this method, the RCST will locate a sequence of adjacent logon timeslots available in the superframe and shall aim the logon transmission at a specific timeslot in this sequence. The size of the sequence of adjacent timeslots used to support the method is system dependent.

9.2.4 Acquiring the Superframe Sequence for Operation

The RCST shall default to use the SFS assigned in the RMT for its successive operation if it is not explicitly assigned another operational SFS by the logon response TIM-U. The RCST may be assigned the SFS to use for the successive operation via the Satellite Return Link Descriptor sent in the logon response TIM-U. The RCST shall then use this SFS for subsequent operation instead of the SFS assigned by the RMT. This may be another SFS than the one assigned for logon by the RMT and the SFS may be provided without logon timeslots. The SFS assigned in TIM-U may be assigned to the RCST with an instruction to use an offset relative to the absolute frequency determined by the SCT and FCT2 alone, as specified for the Satellite Return Link Descriptor.

The NCC may change the operational SFS by sending an update of the Satellite Return Link Descriptor to the RCST.

The RCST shall not attempt to re-logon via the operational SFS reference provided via the TIM-U, but shall resort to the SFS reference provided via the RMT. This reference may be found through a full re-acquisition of the forward link.

9.2.5 TDMA Synchronization Procedure

The TDMA Synchronization Procedure is illustrated in figure 9-4. This procedure utilizes dedicated access control timeslots. Configuration parameters for this process are provided in the Correction Control Descriptor sent in TIM-B and in the Control Assign Descriptor sent in TIM-U.

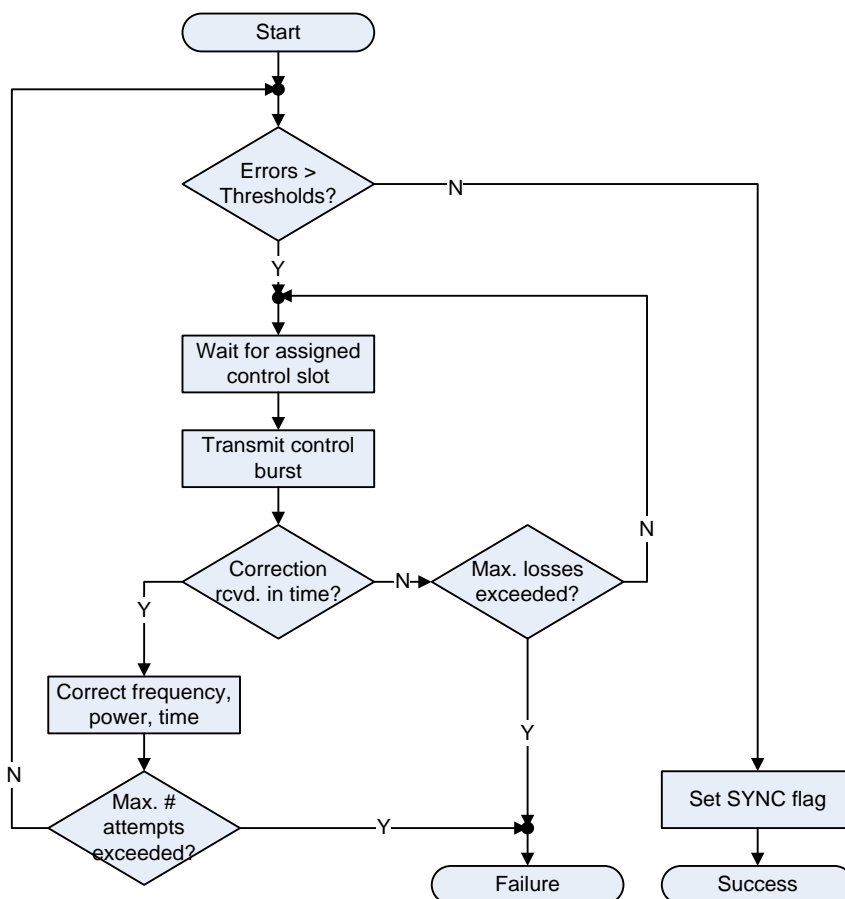

Figure 9-4: TDMA Synchronization Procedure

The procedure is completed with success when the errors indicated in either the Correction Message Descriptor sent in TIM-U or errors indicated the CMT are smaller than both an indicated non-zero frequency threshold and an indicated non-zero timing threshold. If these thresholds are both zero, the procedure is unconditionally completed with success.

The number of missing responses to dedicated control transmission is supervised. The maximum number of losses (control_max_losses) refers to the maximum number of consecutively losses of the response to the control burst that shall be tolerated. The maximum number of attempts (max_sync_tries) refers to the maximum dedicated access control timeslot transmissions. The procedure shall be considered unsuccessful if either the maximum number of losses is exceeded or the maximum number of attempts has been made without getting the required response.

NOTE 1: The RCST may consider any addressed response with either correction of or status of the physical layer (CMT or CMD) as a response to a control burst.

NOTE 2: The RCST may supervise its connection to the NCC and silently log off if not being specifically addressed by the NCC for a longer period of time.

9.2.6 Synchronization Monitoring Process

The RCST shall proceed with monitoring response and lack of response to control transmission in dedicated access control timeslots as for the TDMA Synchronization procedure. This procedure is carried out at the pace of the assignment of dedicated access control timeslots as shown in figure 9-5.

The procedure is similar to the TDMA Synchronization Procedure, but in this procedure the RCST shall consider any correction value that exceeds a non-zero threshold as a failure. As for the TDMA Synchronization Procedure the RCST shall consider excess of the maximum number of consecutive losses of dedicated access control burst responses as a failure.

The RCST shall not consider the correction value for a parameter with a zero threshold for the evaluation of sync loss.

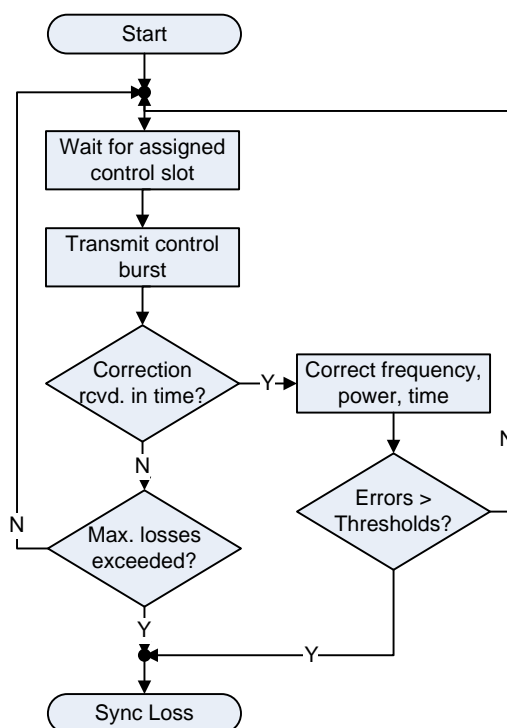

Figure 9-5: Synchronization Monitoring Procedure

When the RCST operates in non-persistent continuous carrier mode, the NCC may at any time send a TIM-U requesting the RCST to report the cumulative timing or frequency correction instructions accrued since the last correction was applied; typically corresponding to the start of continuous transmission. These corrections are to be applied by the RCST when returning to burst transmission without re-acquisition of timing and frequency offset. The RCST shall respond with the lowest extreme value if not accruing a given correction, and shall respond with the latent correction value if accruing the correction when transmitting continuously.

9.2.7 Logoff Procedures

An RCST can be logged off from the interactive network in one of the following ways:

- **Solicited Logoff:** An RCST may issue a logoff request and a logoff reason in the lower layer signalling. Upon reception of the logoff request the NCC shall reply with the log-off instruction and a logoff reason in a TIM-U. The reception of this instruction at the RCST shall be treated as an NCR Instructed Logoff.
- **NCC Instructed Logoff:** The NCC may issue a logoff instruction to the RCST. Upon reception of this, the RCST shall cease transmission and proceed to the Off/Standby state, if not in the Hold/Standby state.
- **Autonomous Silent Logoff:** This is the result either of the NCR recovery timeout that may occur while the RCST is in the NCR Recovery state or any other condition in which the RCST should itself determine that it is no longer controlled by the NCC, which shall include excessive interruption of the forward link, excessive loss of response to control bursts in dedicated access control timeslots and lack of response to the logoff request. The RCST shall cease transmission and proceed to the Off/Standby state.

The RCST shall log off silently if it is not assigned a DA transmission opportunity for a given interval of time, i.e. it is considering itself unattended by the NCC. The RCST shall apply DA assignment supervision and autonomously and silently logoff if it has not been assigned DA transmission resources in an interval of:

$$(\text{control_max_losses}) \times (\text{control_repeat_period} + 1) \times \text{superframe_duration}$$

These parameters are provided by SCT and the TIM-U, in the Control Assign Descriptor and Correction Control Descriptor.

9.2.8 Control of Continuous Carrier Transmission

RCSTs that support continuous carrier in the return link operate according to a state diagram as shown in figure 9-6. The following states and transitions exist in addition to those defined in clause 9.2.1. The transitions are highlighted in figure 9-6.

Continuous Carrier: This is the state for transmission of a continuous carrier in the return link. This is an absorbing state in persistent CC mode; the RCST remains there until external events dictate transition to another state. Transmission of the continuous carrier is allowed in this state, subject to the provisions in this clause. In this state, when starting CC transmission or receiving a superseding CC assignment involving a change in frame_number, the RCST shall take the following steps:

- The RCST shall start transmitting according to carrier assignment either immediately after having acknowledged the assignment (in case of a persistent carrier assignment) or at the time indicated in the assignment (in the case of an assignment by the TBTP2).
- All initial continuous carrier frames shall include a Control PDU requesting acknowledgement of receiver acquisition. This shall continue until an acknowledgement is received or until the process times out.
- The process shall time out and the RCST shall proceed to the "Ready for Logon" state if such an acknowledgement is not received within 10 seconds. This will also terminate persistent continuous-carrier mode.
- Other information shall not be transmitted until the receiver acquisition acknowledgement is received. However, if the NCC allows immediate transmission of user data in the assignment / configuration message through the "early_user_data_allowed" flag, transmission of other information may start at the same time as the physical carrier transmission.
- The RCST shall in this state treat corrections that may be received in the CMT and TIM-U as follows:
 - It shall keep a highly regular symbol and chip timing in the transmission independent of timing corrections issued by the NCC, with a regularity as if these timing corrections were not received.
 - It may follow carrier frequency corrections for the continuous transmission, and shall then sustain the applied carrier frequency correction if returning to burst mode without re-acquisition.

- It may follow EIRP corrections as specified in clause 9.9.1, and shall then sustain a corrected EIRP level if returning to burst mode without re-acquisition.

The following commands and events control the operation of the RCST in continuous-carrier mode:

- During initialization, an RCST operating in the persistent continuous carrier mode shall transition from the "Ready for Logon" state to the "Continuous Carrier" state directly, without issuing a logon burst.
- An RCST in the "TDMA Sync" state that receives a continuous-carrier assignment either in the form of a "Continuous Carrier Control Descriptor" descriptor for transition to persistent CC mode, or in the TBTP2 for transition to non-persistent CC operation, shall do the following, in the order defined:
 - When following a persistent carrier assignment (in a CC control descriptor), acknowledge that the RCST proceeds with transition to CC by issuing a CC control message with acknowledgement by burst transmission before the transition. This indicates to the NCC that the RCST will now leave the TDMA mode.
 - Cease transmission of MF-TDMA bursts, even if there are assigned more timeslots.
 - Proceed to the "Continuous carrier" state and start transmission of the assigned carrier. The RCST will keep assigned identifiers and continue to use them in continuous-carrier mode.

NOTE: Reception of configuration information for non-persistent operation in the CC Control Message does not in itself imply a state change.

- An RCST in the "Continuous Carrier" state operating in "non-persistent mode" which receives a carrier assignment through the TBTP2 shall stay in the CC state, provided the assignment is supported. Otherwise, it shall leave the state and return to TDMA operation via the "Ready for Logon" state.
- An RCST in the "Continuous Carrier" state which receives a "TX Disable" command shall immediately proceed to the "Hold/Standby" state and cease transmission. This will not terminate persistent mode operation.
- An RCST in the "Continuous Carrier" state which loses contact with the forward link for a period of more than 60 seconds shall proceed to the "Off/Standby" state. This will not terminate persistent mode operation.
- An RCST in the "Continuous carrier" state shall cease transmission within 2 seconds when any of the following events occur:
 - A command terminating a current persistent mode operation is received. The RCST shall return to TDMA operation via the "Ready for Logon" state.
 - A command revoking the carrier assignment is received. This will not terminate persistent mode, and the RCST will stay in the CC state and await further instruction.
 - A command to issue logon in TDMA mode is received. This will terminate persistent mode operation and the RCST will return to TDMA operation via the "Ready for Logon" state.
 - A non-persistent carrier assignment expires without having been renewed. The RCST shall return to TDMA operation in one of the ways described later.
 - An update to the SCT, FCT2 or BCT version number is detected. This event shall cause the RCST implicitly to relinquish the carrier assignment. This will not terminate persistent mode operation, and such an RCST will stay silently in the CC state awaiting further instruction, which may be a carrier assignment following the update of the other tables.
 - A command to logoff the interactive network is received. The RCST shall then cease transmission as specified in clause 9.2.7 and proceed to the Off/Standby state. This will not terminate persistent mode operation and will not revoke current carrier assignment for this mode.

The RCST may proceed to the "Ready for Logon" state when reconnecting in TDMA after the carrier assignment validity expires. However, if specifically so allowed by instructions conveyed in the "Continuous Carrier Control Descriptor" in the TIM, the RCST may alternatively proceed directly to the "Ready for TDMA sync" state or the "TDMA Sync" state. The RCST may only proceed to other states than the "Ready for Logon" state if it has maintained the burst timing and carrier frequency accuracies to be within margins applicable for transmission in the respective state.

In non-persistent CC mode, the RCST shall logoff and indicate this in-band prior to premature cessation of the CC transmission i.e. without having been instructed by the NCC, unless prevented from transmitting this by an overriding cause such as equipment malfunction or power interruption.

All other transitions remain as defined in clause 9.2.1.

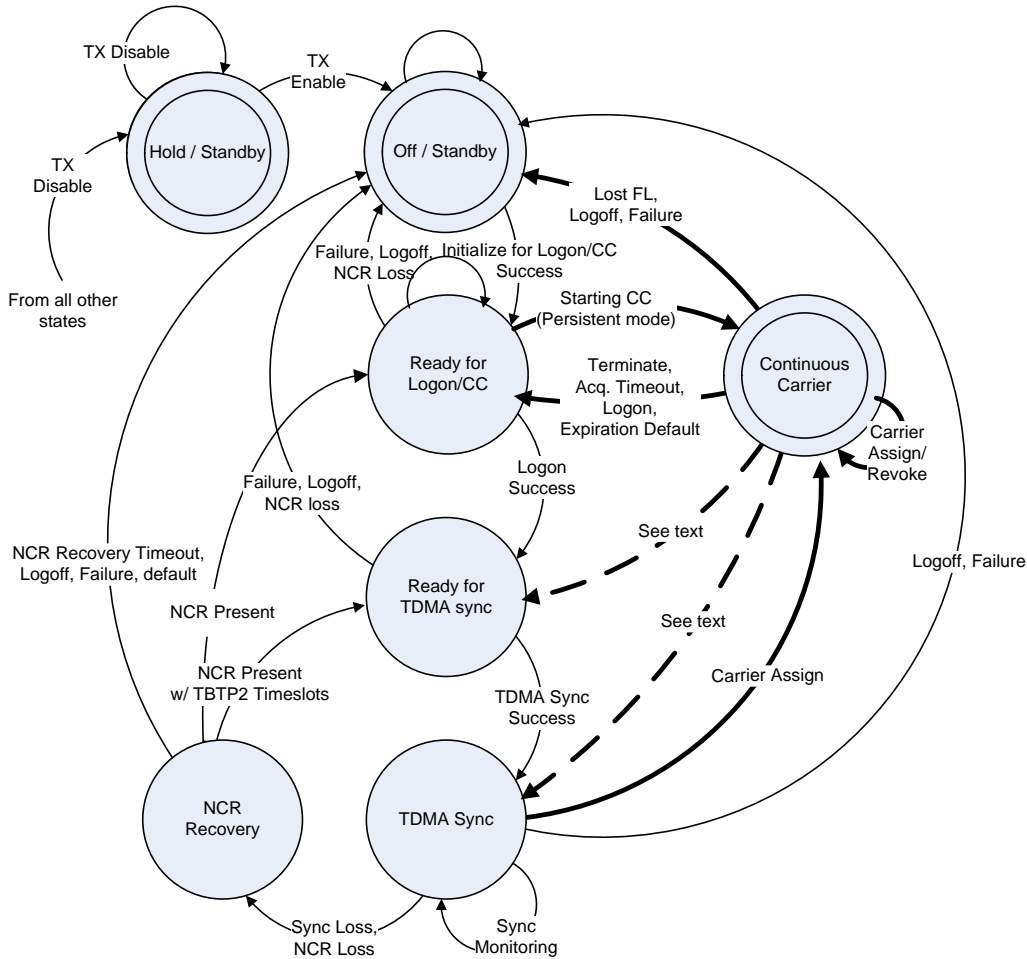

Figure 9-6: RCST state diagram including continuous-carrier transmission

9.3 Protocol Type Support

The RCST shall support the protocol types for L2S. The RCST is assumed to be administratively configured to handle higher layer protocol types for user traffic.

9.4 Interactive Network Entry

9.4.0 Introduction

An interactive network is entered by an RCST by sending a logon burst and receiving one or more TIM-U as response. The logon burst has payload that carries requests and status information. TIM-U carries a response to this as well as configuration data required by the RCST. TIM-B provides information that is relevant for how the RCST shall issue and format logon to the network.

Some lower layer signalling system negotiations are specified. Negotiations based on higher layers transported as user traffic at the lower layers are out of the scope for the present document and are addressed by ETSI TS 101 545-3 [i.16].

9.4.1 Entry Type Indication

The variant of the network entry type shall be explicitly indicated in the logon request.

The following entry types are recognized:

- 1) Alignment request entry.
- 2) Subscription request entry.
- 3) Re-entry.
- 4) Re-entry and implicit logoff.

9.4.2 Alignment Status

The RCST shall in the logon request indicate its alignment status as earlier confirmed by the NCC which the RCST sends the logon request to. The RCST shall indicate that the status is "confirmed-aligned" to the NCC if that NCC has previously indicated that the RCST has been aligned, and the RCST has not in between been realigned towards another system or may expect that it has lost the previous alignment. If any of the latter concerns the RCST, it shall indicate that it is "not confirmed-aligned" in the logon request sent to the NCC. This allows the NCC to consider realignment before allowing the RCST into the network.

The RCST shall at a change in either of the NIT ONID, the RMT INID or the Satellite IDs set the status to "not confirmed aligned". The RCST shall raise the status to "confirmed-aligned" once the NCC has indicated this. The policy that the NCC uses to decide the status is system dependent.

9.4.3 Subscription Status

The RCST shall in the logon request indicate its subscription status as previously confirmed by the NCC. The RCST shall indicate that the status is "confirmed subscription" if the NCC has previously indicated that the RCST is properly subscribed and the RCST has not in between been subscribing for access in another system. If the latter concerns the RCST, it shall indicate that it is not confirmed subscribed in the logon request sent to the NCC. This allows the NCC to consider re-initialization of subscription before allowing the RCST into the network. The RCST shall utilize a change in the NIT given ONID and the RMT given INID to identify a change of system.

The RCST shall raise the status to "confirmed-subscription" when the NCC has indicated this status. The policy that the NCC uses to decide the status is system dependent.

The RCST shall when indicated required by the NCC as described in clause 6.4.17.23 identify the user in the logon request when logging on with the RCST in the "non-confirmed subscription" state. The NCC may silently discard logon requests that are issued without sufficient credentials.

The RCST shall when indicated required by the NCC as described in clause 6.4.17.23 include the signature of the user when logging on with the RCST being in "non-confirmed subscription" state. The NCC may require a signature with every logon request. The NCC may silently discard logon requests that are issued without sufficient credentials.

The NCC may, as a response to a subscription request indicate that the RCST is not in a state that allows associating a subscription with the RCST. The NCC may e.g. reject subscription of an RCST that is not properly aligned.

9.4.4 Higher Layers Initialization Status

The RCST shall at logon in the logon FPDU indicate if the NCC has indicated that its satellite side interfaces currently are initialized for higher layer operation. The policy that the NCC uses to decide the status is system dependent.

A change in any of the parameters NIT given Original Network ID and RMT given Interactive Network ID shall trigger the RCST to discard the M&C IPv4 addresses once given in TIM-U and indicate this status in the logon request by indicating that it is currently not initialized for higher layer protocol operation.

9.4.5 Commissioning Status

The RCST shall in the logon request indicate its commissioning status as earlier confirmed by an NCC in the current combination of ONID and Interactive Network ID. The RCST shall indicate that the status is "confirmed-commissioned" to the NCC if that NCC has previously indicated that the RCST has been commissioned, and the RCST has not in between been re-commissioned towards another system or may expect that it has lost the previous alignment. If any of the latter concerns the RCST, it shall indicate that it is "not confirmed commissioned" in the logon request sent to the NCC. This allows the NCC to consider commissioning before allowing the RCST into the network.

The RCST shall at a change in either of the NIT given ONID or the RMT INID set the status to "not confirmed commissioned". The RCST shall raise the status to "confirmed-commissioned" once the NCC has indicated this. The policy that the NCC uses to decide the status is system dependent.

9.4.6 Lower Layer Capabilities

A data set indicating the RCST capabilities is forwarded to the NCC at logon as an element in the logon FPDU. Configuration is received from the NCC at logon, in TIM-U.

9.4.7 Higher Layer Capabilities

A data block may be broadcast by the NCC in TIM-B in the same type of descriptor as used in TIM-U. This data block is handed over to the higher layers at start-up with indication of the source being TIM-B.

A small data block may be forwarded to the NCC via the logon burst and/or via a control PDU.

A data block is sent from the NCC to the RCST by TIM-U in a descriptor dedicated to carry higher layer instructions. The RCST hands this over to the management entity when receiving it.

The lower layers have no notion of the content of these blocks. The utilization of the blocks is specified by ETSI TS 101 545-3 [i.16].

The size of the different blocks is out of scope for the present document. Care shall be taken so that the block fits within the logon payload together with other information that has to be sent. If the block is too large for the logon burst it may be submitted in the control burst.

9.4.8 Providing the unicast MAC Addresses for the Higher Layers

The RCST operating on a continuous generic stream shall accept link addressing for the higher layer protocols using the unicast MAC24 addresses assigned for each SVN interface in the logon response TIM-U. The SVN corresponding to the interface is identified by a 16 bit SVN number constructed by taking the most significant mac24_prefix_size bits from the MAC24 and extend these with '0' least significant bits. The RCST shall accept higher layer unicast traffic destined to these MAC24 addresses and may discard higher layer traffic to other unicast MAC24 addresses.

The dynamically assigned MAC24 addresses shall be released when logging off if the NCC has not explicitly assigned the MAC24 addresses to be kept after log-off. The RCST shall unconditionally discard all previously assigned MAC24 addresses when the NCC assigns a new set.

The RCST shall autonomously take on a MAC48 address equal to the non-volatile RCST Hardware Identifier. Broadcast signalling tables in the continuous generic stream are issued without the MAC address field. In the TS Packet Stream broadcast signalling the address label is either omitted for a broadcast table (concerns all other broadcast tables than TIM-B) or it is specifically indicated to be a broadcast by the destination MAC48 address 0xFFFFFFFFFFFF (concerns only TIM-B).

9.4.9 Lower Layer Service Assignment

As a default, an RCST shall map all its higher layer aggregate traffic to the provisioned lower layer service with the index of the lowest value as indicated in the Lower Layer Service descriptor provided at logon. An NCC shall be capable of providing the RCST with a lower layer service and shall indicate the appropriate lower layer service specification in the Lower Layer Service descriptor issued as part of the logon response TIM-U.

An RCST shall comply with the lower layer service configuration as the NCC provides this via the Lower Layer Service descriptor in TIM-U. The NCC may provide the RCST with lower layer services, respecting the capacity of the RCST. The RCST shall be capable of utilizing this additional provisioning.

Managed configuration of the RCST may instruct the RCST to map higher layer traffic aggregates to other lower layer services than the default.

An RCST shall keep its lower layer service configuration across reboots and re-logon as long as it connects to the same NCC. Change in any of the parameters NIT given Network ID, RMT given Interactive Network ID and RMT given NCC ID shall trigger the RCST to discard its current lower layer service configuration. The NCC may via L2S reconfigure the lower layer services of the RCST that was originally provided by the L2S, and the RCST shall accept this reconfiguration.

An RCST shall not issue capacity requests in excess of the rules explicitly given by the NCC. By default an RCST may only assume that there is no other lower layer service than dedicated assignment by FCA.

The NCC may provide one or several dedicated access allocation channels by Assignment IDs in the Logon Response descriptor. The NCC indicates in the Lower Layer Service descriptor the nominal allocation channel that applies for each lower layer service, and by this indirectly indicates the nominal allocation channel for the different higher layer aggregates that map to the associated lower layer services.

The NCC may indicate allowance to use a nominal random access allocation channel for a service, and will then also indicate the default RA traffic control parameters that apply for operation on this allocation channel.

The NCC indicates in the Lower Layer Service descriptor also:

- Permission to map resource demand associated with a lower layer service to other specific rc_index values than the nominal.
- Permission to submit traffic associated with a lower layer service into other allocation channels than the nominal allocation channels.

The policies for utilizing alternative mapping are out of scope for the present document.

9.4.10 Initialization of the Higher Layers

The RCST shall support initialization for IPv4 based M&C at each layer 2 interface, by the Higher Layers Initialization descriptor. The NCC may use the Higher Layers Initialization descriptor to initialize each of the layer 2 interfaces at the RCST for IPv4 based M&C. This initialization shall be persistent across RCST restart and reboot. This descriptor provides parameters supporting further configuration of the higher layers via IPv4 specified in ETSI TS 101 545-3 [i.16].

A change in any of the parameters NIT given Original Network ID and RMT given Interactive Network ID shall trigger the RCST to discard the M&C IPv4 addresses given in TIM-U.

Higher layer based methods for M&C IPv4 address assignment may be supported. This is out of scope for the present document. Higher layer addresses for user traffic are assumed managed via IPv4 based M&C.

The RCST shall turn off higher layer PEP functions per virtual interface as indicated in the Higher Layers Initialization descriptor, at reception of this descriptor. The RCST shall, following this event use the native higher layer protocols without PEP interception for the traffic via the respective virtual interfaces, until PEP functions are explicitly turned on again.

9.4.11 Initialization for Mesh Communication

The NCC may include the Mesh System Descriptor (MSD) in TIM-B to indicate explicitly the individual frames that may be used for mesh traffic. For each Super-frame used for mesh traffic, the MSD indicates the transponder frequency offset that apply for these frames, allowing a transparent mesh overlay RCST to tune its TDMA receivers to the corresponding mesh downlink carriers. The NCC may consider that assignments in the listed frames constitute one shared physical layer for all the mesh receivers using the same super-frame, and will then indicate this.

If the MSD is present but indicates no specific superframes and frames, assignments in superframes and frames are to be considered useful for mesh uplink under dynamic connection control by the NCC, with mesh downlink implemented through regeneration into TDM.

Absence of the MSD indicates that mesh communication is not supported in the satellite network.

The Extension Protocol Descriptor (EPD) is used to indicate the connection details for the dynamic connectivity protocol. The EPD is given in Logon Response TIM-U. The descriptor is defined in clause 6.4.17.31.

9.5 Return Link Timeslot Grid Control

The timeslot grid of the superframe may be controlled by the SCT/FCT2/BCT alone, and by these in combination with the TBTP2. There are two means provided intended for allowing the timeslot grid to be dynamic. There may be generic unit timeslots defined in a frame where the TBTP2 decides the utilization of these just in time, possibly by aggregating generic unit timeslots adjacent in time to larger timeslots capable of transporting larger bursts. Also, there may be overlapping frame specifications defined for the superframe sequence where different types of timeslots are allocated by the NCC by alternating the allocation between the overlapping frames.

9.6 Timeslot Access Method Control

The specific access method to be used for burst transmission in a given timeslot is either determined by the FCT2 or it is determined by the TBTP2. Dedicated access in timeslots is determined by the TBTP2. Random access in a timeslot may be determined either by the FCT2 or by the TBTP2.

Continuous transmission in the interval of a timeslot can be determined in advance either by the TBTP2 or by the CC Control Descriptor sent in a TIM-U.

9.7 Random Access Load Control

9.7.1 Contention Control for Logon Timeslots

9.7.1.1 Stationary RA Load Control for Logon

The stationary load control scheme for logon has two components, one aimed at controlling the normal operation load level on the logon channel and one aimed at limiting the intensity of autonomous transmission to comply with regulatory requirements.

The RCST shall impose a random hold-off when repeating transmission of an RA logon request when not getting a response or being rejected. Retransmission by RA is to be done after a random interval. Parameters for the retransmission scheme are retrieved by the RCST from the Logon Contention descriptor sent in TIM-B.

The RA hold-off interval shall in the initial iteration of the logon procedure be a uniformly distributed random variable in the range from now up to a programmable maximum $[0, \text{max_time_before_retry}]$, provided by the NCC in the Logon Contention Descriptor sent in TIM-B.

If the logon procedure fails without response, further RA re-transmission of logon request shall take place in a random access logon timeslot occurring after a random interval being a uniformly distributed random variable in the interval $[0, n^2 \times \text{max_time_before_retry}]$ where n is one more than the number of consecutive iterations of the logon procedure completed with failure due to lack of response from the NCC (as shown in figure 9-3).

The counter n shall be reset to '1' when:

- The RCST receives a logon response TIM-U (as shown in figure 9-3).
- The NCC raises in TIM-B the Link Failure Recovery flag or the Logon Link Failure Recovery flag.
- The RCST is ordered to explicitly wakeup by a TIM-U.

When a local operator explicitly re-initiates logon by a manual administrative procedure this may implicitly reset n to '1'. The RCST may reset n to '1' when connecting to the forward link of another network as identified by the NIT-ONID and the RMT-INID.

Automatic return to the Off/Standby state in figure 9-3 shall alone not reset n .

9.7.1.2 Dynamic RA Load Control for Logon

The randomization interval indicated for the stationary load control as indicated by the `max_time_before_retry` in the Logon Contention descriptor may be changed runtime by the NCC.

The NCC may indicate that the RCST is expected to follow a pre-defined procedure for large outage recovery, by raising the Link Failure Recovery flag in the TIM-B. The pre-defined procedure is implementation dependent.

9.7.2 Contention Control for Control Timeslots (optional)

9.7.2.0 Introduction

An RCST may use the contention control timeslots at its own discretion, e.g. for issuing resource requests when dedicated resources for capacity request signalling are not sufficient for satisfying the service requirements or expectations. The utilization policy is considered implementation dependent.

9.7.2.1 Stationary RA Load Control for Control Signals

The NCC indicates in the Lower Layer Service Descriptor in TIM-U the default value for the minimum randomization interval for uniformly distributed random selection of a slotted aloha control timeslot among all such timeslots as provided by the SCT and FCT2 in combination with the TBTP2. The RCST shall when using slotted aloha for control signalling uniformly randomize the selection of a control timeslot from the set of such timeslots present in the SFS in the interval from the current time up to the randomization interval.

The RCST shall interpret the value 255 of the parameter `default_control_randomization_interval` in the Lower Layer Service Descriptor as not allowing the RCST to issue any RA control signals even if timeslots for RA control signalling are provided.

9.7.3 Contention Control for Traffic Timeslots

9.7.3.0 Introduction

Random Access Traffic Method descriptor indicates the load control method that is statically assigned to the RA allocation channel. `load_control_method==0` in Random Access Traffic Method descriptor indicates that no load control mechanism is to be used for the RA allocation channel. In this case, mechanisms at higher layers are assumed to exist that self-regulate the source traffic and avoid overloading the random access allocation channel.

If, for a given RA allocation channel, a nonzero value is assigned to the `load_control_method` in the Random Access Traffic Method descriptor, then the RCST shall implement in this RA allocation channel stationary load control unless dynamic load control is enabled. Clause 9.7.3.1 explains stationary load control. Clause 9.7.3.2 explains dynamic load control.

RA load control is based on the structuring of the superframe into time sections independently per RA allocation channel, called RA blocks. The structuring is specified by the Random Access Method Descriptor. If no specific RA block is specified, the structure defaults to a single RA block that equals the superframe in duration.

9.7.3.1 Stationary RA Load Control for Traffic

Stationary load control defines RCST load control behaviour when dynamic load control is not applied. In stationary load control, the RCST shall adopt the load control parameter values that are present in the Lower Layer Service descriptor.

The load control parameter values in the Lower Layer Service descriptor are also the default parameter value settings for each RCST for the given load control method.

If dynamic load control is enabled, then the load control parameter value settings in the Random Access Load Control descriptor override the load control parameter value settings in the Lower Layer Service descriptor.

A load control method may allocate one load control parameter value for use in the Random Access Load Control descriptor to indicate that the RCST shall adopt the default value for the parameter as assigned in the Lower Layer Service descriptor.

The RCST-side implementation of a specific load control method is the same in both stationary and dynamic load control. Clause 9.7.3.2 explains dynamic load control and RCST-side implementation of the load control mechanism that corresponds to `load_control_method=1` in the Random Access Traffic Method Descriptor.

9.7.3.2 Dynamic RA Load Control for Traffic

The Random Access Load Control descriptor provides the values assigned by the NCC to the load control parameters.

The RCST-side implementation of the load control mechanism may be dependent on the access mechanism; Slotted ALOHA (SA) vs CRDSA.

In both SA and CRDSA RA allocation channels, the timeslots that belong to a random access allocation channel in a superframe may belong to different RA blocks. An RA block is a component of the superframe and is defined in the Random Access Traffic Method descriptor. It is possible to define RA blocks with boundaries that coincide with the superframe boundaries.

A separate instance of the load control mechanism shall run in RCST for each RA channel. The remaining text explains the RCST normative behaviour to implement the load control method indicated by `load_control_method==1`. The variables, `back_off_time` and `back_off_probability`, are both defined in the Random Access Load Control descriptor for `load_control_method==1`.

In both SA and CRDSA, when new data is received in the transmission buffer, the RCST shall delay RA allocation channel access by `back_off_time` with probability `back_off_probability`. At the end of the `back_off_time`, the RCST shall access the RA allocation channel in each "transmission opportunity" with $(1 - \text{back_off_probability})$ or avoid using the "transmission opportunity" with `back_off_probability`, until the transmission buffer contents are fully transmitted. The definition of "transmission opportunity" is different for SA and CRDSA.

In CRDSA RA allocation channels, the "transmission opportunity" is the RA block in the superframe. The transmission is repeated a defined number of instances for each unique payload. If the load control mechanism results in the decision to access the RA allocation channel, then the RCST shall transmit in the RA block. The number of unique payloads that can be transmitted in the RA block shall be upperbounded by `max_unique_payload_per_block` value in the Lower Layer Service descriptor. When using RA allocation channels, the RCST shall not violate the loading bounds that are dictated by the `max_unique_payload`, the `max_consecutive_blocks_accessed`, and the `min_idle_blocks` parameters in the Lower Layer Service descriptor.

In SA RA allocation channels, the slotted ALOHA timeslot is the "transmission opportunity". If the load control mechanism results in the decision to access the RA allocation channel, then the RCST shall transmit one unique payload in the Slotted ALOHA timeslot. In case SA timeslots are available in more than one carrier in the superframe, then the RCST shall consider each SA timeslot for transmission opportunity in order. The order of consideration shall follow the convention; from {lowest superframe_count, lowest timeslot number in the superframe} to {highest superframe_count, highest timeslot number in the superframe} in falling precedence first according to increasing superframe_count and then according to increasing timeslot number in the superframe.

In both SA and CRDSA allocation channels, the RCST shall not violate the loading bounds that are dictated by the `max_unique_payload_per_block`, the `max_consecutive_blocks_accessed`, and the `min_idle_blocks` parameters in the Lower Layer Service descriptor.

More specifically:

- the number of unique payload transmissions in the current RA block shall not exceed the `max_unique_payload_per_block` value in the Lower Layer Service descriptor;
- the number of consecutive RA blocks that the RCST transmits in shall not exceed the `max_consecutive_blocks_accessed` value in the Lower Layer Service descriptor; and
- if the `max_consecutive_blocks_accessed` has been reached, the RCST shall not access the RA allocation channel before `min_idle_blocks` number of RA blocks have passed.

9.8 Forward Link Feeder MODCOD Control

ACM on the forward link under control of the NCC is done by the RCST by transmitting the current estimate of the forward link CNI and the MODCOD_RQ parameter that are defined in clause D.5 of ETSI EN 302 307-1 [2].

As indicated in ETSI EN 302 307-1 [2], the MODCOD_RQ parameter allows either requesting a particular transmission mode characterized by MODCOD and the presence of pilot symbols, or indicating that information is not available and no particular transmission mode is requested. The RCST shall use the MODCOD_RQ parameter to indicate the appropriate supported MODCOD according to the Transmission Mode Support Table 2 (TMST2) that at present provides the lowest useful link margin, essentially issuing a *least margin transmission mode* request as MODCOD_RQ, with reference to the use of pilot or not, as indicated supported by the TMST2. The RCST should repeat this request to ensure that the request reaches the NCC. The RCST shall transmit the current estimate of the forward link CNI together with the derived LMMR. The RCST is expected to report the CNI on a regular basis to allow the NCC to supervise the link conditions for the RCST. The NCC shall avoid issuing unicast traffic with a MODCOD with a CNI threshold higher than the transmission mode requested by the RCST considering also to the indicated use of pilots, but may choose to do this using the transmission mode with the lowest CNI threshold in use in the system and supported by the RCST.

TMST2 specifies the set of transmission modes supported by the network for forward link transmission, with their presumed CNI margins that are assumed required applied by the transmission mode control. The RCST is assumed to request the most applicable transmission mode from the TMST2 according to the estimated forward link CNI, the sensitivity threshold and the indicated margins required. Only a mode from the set offered by TMST2 may be indicated. The RCST shall respect the required margins as indicated in the TMST2 when selecting the appropriate transmission mode.

The NCC adapts the mapping of RCST specific traffic to PLFRAME according to the transmission modes that the specific RCST is able to receive. The NCC shall either map specifically to the transmission mode that the RCST has requested or any of the other transmission modes that also appear in the TMST2 and has a lower nominal CNI reception threshold.

There is a common CNI offset and CNI offset per MODCOD as part of TMST2. This shall be used by the RCST when deciding the MODCOD request.

9.9 Control of RCST Transmission Characteristics

9.9.1 EIRP Control

The RCST that supports EIRP control shall be capable of adjusting the reference EIRP in steps of nominally 0,5 dB over the operating range specified by the manufacturer, and shall do this as instructed by the NCC via the Correction Message Descriptor in TIM-U and the Correction Message Table. Over this range, the terminal output power change shall reflect a power adjust command with the accuracy specified by the manufacturer. The RCST shall generally not reduce its reference EIRP when it is instructed to increase it, and shall not increase its reference EIRP when instructed to reduce it.

The RCST shall autonomously impose the EIRP self-restrictions required to comply with the specifications in clause 7.3.8. Two power control schemes are defined for the RCST, constant EIRP and constant power spectral density, the first being mandated supported. When operating with constant EIRP, the RCST shall seek to maintain the same EIRP for all transmissions, with reference to the EIRP level it is instructed to use. When operating with constant power spectral density, the RCST shall seek to maintain the same power spectral density at all transmissions with reference to the EIRP level it is instructed to use at a given type of transmission. The RCST shall indicate to the NCC its ability to transmit with constant power spectral density as well as constant EIRP. The NCC may indicate which mode the RCST shall use, constant EIRP or constant power spectral density. If the NCC does not issue such information the RCST shall assume constant EIRP. The NCC may provide indication about if it allows an RCST only capable of constant EIRP operation or only capable of constant power spectral density operation to connect to the network.

The RCST shall indicate the maximum non-zero power headroom that applies with its current configuration as the difference between the highest EIRP and the lowest EIRP. This shall be sent in the Maximum Power Headroom field in the return link. The RCST should thereafter when logged on keep the NCC updated about the current RF power headroom for the burst carrying the report. An RCST that is capable of adjusting its power level shall report the actual value for the headroom. A valid value reported for the power headroom shall reflect the actual power headroom as follows:

$$\text{Reported headroom} = \text{Actual headroom} + \text{Error, with Error} \in \{-2 \text{ dB}, 0 \text{ dB}\}$$

The RCST shall transmit at its maximum allowed output power if instructed to increase the power by at least the reported headroom 2 dB.

An RCST capable of adjusting the output power shall indicate the maximum power headroom as the difference between the nominal maximum allowed EIRP and the nominal minimum EIRP the RCST can transmit, referring to the carrier and transmission mode transporting the report. An RCST that does not indicate the maximum power headroom may be assumed to have zero maximum power headroom.

The RCST is allowed to instantaneously increase its EIRP up to the maximum allowed power level when instructed to do so.

An RCST shall by default use E_s/N_0 reported by an NCC for informational purposes and shall not change behaviour upon receiving this information if not explicitly allowed to do so. The RCST may adapt the EIRP autonomously if explicitly allowed in the logon response TIM-U.

An RCST transmitting a continuous carrier shall, when changing from a lower order modulation to a higher order modulation, ensure that there is sufficient RF power back-off in place to avoid violation of the adjacent channel power emission mask defined for burst transmission and given in clause 7.3.8.

9.9.2 Transmission Duration Control

The duration of the burst mode transmission is either given directly from timeslot and transmission type specification in FCT2 and BCT, or the reference to BCT from FCT2 may be given indirectly via the TBTP2 by reference to a transmission type in the TBTP2.

The duration of non-persistent continuous carrier transmission is determined by the NCC. The NCC indicates the number of superframes that can pass without a refresh by the TBTP2 before the transmission shall cease autonomously. The NCC is assumed to repeat assignment in TBTP2 as required to keep the continuous transmission with cessation at the timeout. The RCST shall nominally keep on transmitting until this timeout.

The duration of persistent continuous carrier transmission as assigned by NCC via TIM-U is until a revocation signal is received from the NCC, or any of the other preconditions for transmitting are not in place as defined in clause 9.2.8. The RCST may autonomously directly take up the persistent continuous transmission at initialization unless a revocation signal has been received or preconditions are not in place.

The RCST shall terminate the continuous transmission when any of the termination conditions in clause 9.2.8 applies.

9.9.3 Symbol Rate Control

The symbol rate is determined by reference to the frame type in the FCT2 and the specification of the BTU for the frame type.

The NCC may change the symbol rate of ongoing continuous carrier transmission by referring to another frame in the superframe. If the frame_number of a continuous carrier assignment is changed in a successive continuous carrier assignment, the RCST shall behave as for the initial carrier assignment as specified in clause 9.2.8.

9.9.4 Return Link MODCOD Control

The modulation and coding of the burst mode transmission is either given directly from timeslot and transmission type specification in FCT2 and BCT, or the cross reference between FCT2 and BCT may be given by the TBTP2 by reference to a transmission type in the TBTP2.

When the access method is determined by the TBTP2, as it is for dedicated access, the FCT2 may determine a default tx_type in advance and the TBTP2 may or may not override this tx_type by another tx_type that occupies the same number of BTUs for the timeslot as the tx_type pre-determined by the default tx_type. This type of conditional predetermination of the tx_type may only be used for dedicated access, it does not apply to random access. The method cannot be used to change the content type to be transmitted as indicated by the default tx_type, it may only be used to change modulation, FEC and burst construction from that indicated by the default tx_type.

The NCC may change the MODCOD of an ongoing CC transmission by assigning a different tx_type to the RCST. If the frame_number of a continuous carrier assignment changing tx_type is the same in a successive continuous carrier assignment, the RCST need not interrupt its transmission, but shall initiate a countdown sequence indicating to the receiver in advance the first frame that will use the new tx_type. During this sequence, successive carrier frames shall each contain a Control PDU with the "Countdown to tx_type change" message in the CC Control Descriptor. The countdown values shall start at the value set by the tx_type change command or configured by the CC mode configuration command, with precedence to the first command, and shall decrement towards zero. The first carrier frame in the sequence transmitted with the new tx_type shall be the one that corresponds to a countdown value of zero. Inclusion of the countdown message with the countdown value zero is optional. If the countdown start value is set to zero, the new tx_type takes effect immediately and no countdown sequence shall be implemented.

9.9.5 Waveform Configuration Control

9.9.5.0 Introduction

The BCT indicates to the RCST the set of waveforms that are available for transmission. These waveforms may be selected from custom waveforms programmed by the NCC, reference waveforms loaded to the RCST in advance and user defined/system specific waveforms loaded to the RCST in advance. The RCST shall have available all the standardized reference waveforms that applies for its terminal type for reference in the BCT, as listed in annex A. The BCT may mix use of references to preloaded waveforms and specification of waveforms in full detail according to the syntax specified for the BCT.

The method for loading waveforms to the RCST for reference by index from the BCT is out of scope.

9.9.5.1 Configuring the Waveform for TC-LM

The RCST shall support the essential ranges for the TC-LM waveform parameters that are given in table 9-2. Support of 16QAM is optional.

Table 9-2: Essential Value Ranges for TC-LM Waveform Configuration Parameters

Parameter	Range	Unit
Payload modulation scheme	QPSK, 8PSK	
Burst payload size	1 to 1 000	bytes
P	9 to 81	
Q0	0 to 15	
Q1	0 to 15	
Q2	0 to 15	
Q3	0 to 5	
Y Puncturing period	1 to 28	bit
Y Puncturing pattern	0 - (2 ²⁸ -1)	
W Puncturing period	1	bit
W Puncturing pattern	0 to 1	
Number of pilot blocks	1 to 177	pilot blocks
Pilot block length	1	symbol
Pilot period	1 to 768	symbol
Solitary QPSK pilot symbol	(0,0)	
Solitary 8PSK pilot symbol	(0,0,0)	
Solitary 16QAM pilot symbol	(1,1,1,0)	
UW	0 - (2 ¹⁸³ -1)	
Preamble	8 to 155	symbol
Post-amble	8 to 41	symbol
Burst length	262 to 2 660	symbol
Burst start offset	0-(2 ²⁰ -1)	tick
Timeslot size	1 to 6	BTU

Table 9-3 indicates the minimum capacity the RCST shall have to support for concurrent use of multiple TC-LM waveforms.

Table 9-3: Minimum Capacity for Concurrent TC-LM Waveforms

Element	Minimum Capacity
Payload modulation schemes	2
Code rates	5
Transmission types	18
Logon content transmission types	1
Control content transmission types	1
Traffic content transmission types	16

9.9.5.2 Configuring the Waveform for CC-CPM

The RCST shall support operation with the set of waveforms specified for CC-CPM in annexes A, B and C, simply by reference to the waveform_id. The RCST may support programming of custom CC-CPM waveforms using the configuration signal specified in clause 6.4.6.2. The RCST may indicate such support by the flag custom_cccpm_waveform_support in the logon burst.

9.9.5.3 Configuring the waveform for CRDSA TC-LM (optional)

The following essential configuration shall be supported by a CRDSA implementation:

- 1) The RCST shall support use of TC_LM waveform_id=3 and TC_LM waveform_id=13 in table B-1 for CRDSA random access allocation channels.

9.9.5.4 Configuring the waveform for SS-TC-LM (optional)

The RCST shall support the essential ranges for the SS-TC-LM waveform parameters that are given in table 9-4.

Table 9-4: Essential Value Ranges for SS-TC-LM Waveform Configuration Parameters

Parameter	Range	Unit
Payload modulation scheme	$\pi/2$ -BPSK	
Burst payload size	1 to 1 000	bytes
P	9 to 81	
Q0	0 to 15	
Q1	0 to 15	
Q2	0 to 15	
Q3	0 to 5	
Y Puncturing period	1 to 28	bit
Y Puncturing pattern	0 - (2 ²⁸ -1)	
W Puncturing period	1	bit
W Puncturing pattern	0 to 1	
Spreading factor (except logon)	1 to 8	
Spreading factor (logon)	1 to 16	
Number of pilot blocks (except logon)	1 to 255	pilot blocks
Number of pilot blocks (logon)	1 to 2 047	pilot blocks
Pilot block length	1 to 32	chip
Pilot period	1 to 768	chip
Number of pilot chips (except logon)	1 to 5 000	chip
Number of pilot chips (logon)	1 to 15 000	chip
Scrambling polynomial	0x0000	
Preamble	8 to 155	chip
Post-amble	0 to 41	chip
Burst length	262 to 65 535	chip
Burst start offset	0-(2 ²⁰ -1)	tick
Timeslot size	1 to 6	BTU

Table 9-5 indicates the minimum capacity the RCST shall have to support for concurrent use of multiple SS-TC-LM waveforms.

Table 9-5: Minimum Capacity for Concurrent SS-TC-LM Waveforms

Element	Minimum Capacity
Code rates	3
Transmission types	10
Logon content transmission types	1
Control content transmission types	1
Traffic content transmission types	8

9.9.5.5 Configuring the waveform for the Continuous Carrier (optional)

An RCST that declares "Basic continuous carrier support" in the Logon PDU shall support at least the ranges of waveform parameters given in table 9-6. It shall support the corresponding reference waveforms specified in Annex A and provide the capability of supporting waveforms defined through the BCT as specified in table 9-8.

Table 9-6: Essential Value Ranges for Waveform Configuration Parameters, Basic CC support

Parameter	Range	Unit
Payload modulation scheme	$\pi/2$ -BPSK, QPSK, 8PSK	
Burst payload size	1 to 1 000	bytes
P	9 to 81	
Q0	0 to 15	
Q1	0 to 15	
Q2	0 to 15	
Q3	0 to 5	
Y Puncturing period	1 to 28	bit
Y Puncturing pattern	0 - (2 ²⁸ -1)	
W Puncturing period	1	bit
W Puncturing pattern	0 to 1	
Spreading factor	1	
FEC blocks per carrier frame	1	
Carrier Frame Scrambling	unscrambled	
Number of pilot blocks per carrier frame	1 to 177	pilot blocks
Pilot block length	1	symbol
Pilot period	1 to 1 024	symbol
Preamble for carrier frame	8 to 155	symbol

An RCST that declares "Enhanced continuous carrier support" in the Logon PDU shall support the ranges of waveform parameters given in table 9-7. It shall support the corresponding reference waveforms specified in Annex A and provide the capability of supporting waveforms defined through the BCT as specified in table 9-8.

Table 9-7: Essential Value Ranges for Waveform Configuration Parameters, Enhanced CC support

Parameter	Range	Unit
Payload modulation scheme	$\pi/2$ -BPSK, QPSK, 8PSK	
Burst payload size	1 to 1 000	bytes
P	9 to 81	
Q0	0 to 15	
Q1	0 to 15	
Q2	0 to 15	
Q3	0 to 5	
Y Puncturing period	1 to 28	bit
Y Puncturing pattern	0 - (2 ²⁸ -1)	
W Puncturing period	1	bit
W Puncturing pattern	0 to 1	
Spreading factor (BPSK only)	1 to 8	
FEC blocks/FPDUs per carrier frame	1 to 64	
Number of pilot blocks per carrier frame	1 to 1 023	pilot blocks
Pilot block length	1 to 32	chip

Parameter	Range	Unit
Pilot period	1 to 1 024	chip
Number of pilot chips per frame	1 to 8 192	chip
Scrambling polynomial, initialization	any	
Preamble for carrier frame	8 to 155	chip

Table 9-8: Minimum Capacity for Concurrent CC-LM Waveforms

Element	Minimum Capacity
Payload modulation schemes	3
Code rates	5
Burst payload sizes	5
Transmission types	8

An RCST that declares support for 16QAM modulation with continuous carriers shall support that modulation scheme in addition to the waveform parameter ranges required according to the choice of basic or enhanced support.

9.9.6 Contention Diversity Transmission Control (optional)

The following essential configuration shall be supported for a CRDSA implementation:

- 1) Support for CR-CRDSA is required. Support for VR-CRDSA is implementation dependent.
- 2) The RCST shall support single-carrier RA blocks when $\text{nofInstances} \geq 2$.
- 3) The RCST shall be able to support $\text{nofInstances} = \{1,2,3\}$.
- 4) If the configuration is $\text{nofInstances} = 1$ then only the unique payload shall be transmitted and the access method shall be SA, and operation shall be according to the scheme for SA.
- 5) If the configuration is $\text{nofInstances} \geq 2$ then the indicated number of instances shall be transmitted and the access method shall be CRDSA, and operation shall be according to the scheme for CRDSA.
- 6) The RCST shall support RA block duration less than or equal to 150 ms.
- 7) The RCST shall support RA blocks with number of slots from 64 to 128.
- 8) The RCST shall support RA blocks that are submultiples of the superframe duration.
- 9) The RCST shall support RA blocks that are entirely contained in one superframe only and that do not overlap the boundary between two superframes.
- 10) The RCST shall support operation with equal-sized RA blocks with respect to the number of timeslots.
- 11) The RCST shall be able to support transmission of a minimum of one unique payload per RA block.
- 12) The RCST shall support CRDSA random access allocation channel when using the same transmission_type for all the timeslots.
- 13) The RCST shall be able to support minimum one CRDSA random access allocation channel.
- 14) The RCST shall be able to support CRDSA allocation channels without assignment of timeslots to the channel by TBTP2 signalling.

9.10 Frame Payload Format Control

9.10.0 Introduction

Several aspects of the transmission frame payload applied by the RCST transmitter may be chosen by the NCC, given that the RCST supports the chosen format. The RCST will either have to adapt to the indicated format or refrain from transmission. The RCST shall support such control via TIM-B and the Frame Payload Format Descriptor.

9.10.1 Payload Content Type Control

The content type of the burst payload is bound to the timeslot, as given by SCT, FCT2, BCT and TBTP2.

Four types of burst payload content are currently defined:

- Logon.
- Control.
- Traffic/Control.
- Traffic.

The RCST may choose to utilize the payload of bursts for Traffic/Control for either higher layer traffic or control signalling at its own discretion. The NCC may protect traffic timeslots from transmission of control signalling by assigning the Traffic content type to the timeslot.

9.10.2 Frame Payload Format Differentiation

The frame payload format is differentiated between the transmission context types. Some transmission contexts have a non-variant format that is fully specified in the present document. Other transmission contexts use a format that is variant-controlled by the NCC.

The non-variant transmission type contexts that are implicitly recognizable for the RCST are currently:

- Transmission in a dedicated access logon timeslot.
- Transmission in a slotted aloha logon timeslot.
- Transmission in a dedicated access control timeslot.
- Transmission in a slotted aloha control timeslot.

The six variant-controlled transmission type contexts that are recognized in the present document are:

- Transparent star transmission in a dedicated access traffic timeslot.
- Transparent star transmission in a slotted aloha traffic timeslot.
- Transparent star transmission in a CRDSA variant traffic timeslot.
- Transparent mesh transmission.
- Regenerative mesh transmission.
- Transparent star continuous transmission.

Variant control of the frame payload format allows the transmission format to be optimized to the mission. A limited set of variants of the frame payload format is mandated supported by the present document.

The variant transmission context types are supported with control signalling for adaptation of the frame payload format. The NCC shall explicitly indicate to the RCST the specific variant of the frame payload format that is applicable in each of the transmission contexts that is in use in the network. The NCC shall broadcast this indication in the Frame Payload Format descriptor sent in TIM-B.

Before the Frame Payload Format descriptor is received, only the non-variant transmission types can be used by the RCST. A variant format may be used by the RCST when the Frame Payload Format descriptor has provided the configuration.

9.10.3 Frame Payload Format Control

The NCC shall indicate the following in the Frame Payload Format descriptor, for each transmission context that has configurable payload format and that is in use in the network:

- Omission or inclusion of the explicit payload map byte in the first byte of the payload.
- The specific Payload Label size used when omitting the explicit payload map.
- The specific PDU Label size to be used when omitting the explicit payload map.
- The protocol type of the transported SDU if not explicitly indicated by the chosen format.
- The ALPDU Label size associated with ALPDU Label Type '0'.
- Allowance to use the CRC32 method or the sequence number method for integrity protection when fragmenting the ALPDU, or allowance to use either method at RCST discretion.
- Allowance to suppress explicit protocol type indication in the ALPDU.
- Use of either the compressed protocol type or the standard protocol type when including explicit protocol type indication.

9.10.4 ALPDU Label Format Control

The support of an ALPDU label in excess of the ALPDU Label required for holding the SVN tag is optional as the system variants covered by the present document may operate well without more information in the ALPDU.

The SVN tag may be included in the ALPDU label.

The ALPDU Label is of a specified size and may contain an SVN tag of one byte in the MSB. Other use of the ALPDU Label is not applicable for the present specification. The RCST shall include an ALPDU Label with this tag when sending an ALPDU that does not belong to the default SVN of the transmission format. The NCC should provide an ALPDU Label Type of size 1 for this purpose when using SVN separation in the network.

The NCC indicates explicitly in the Transmission Format Descriptor if the ALPDU Label contains the SVN tag in the MSB and shall use this indication to support SVN separation in the transmission from the RCST.

9.10.5 SDU Protocol Type Field Control

There is explicit indication per ALPDU of suppression or inclusion of explicit protocol type indication. This indication is carried by the START PDU and the FULL PDU carrying the ALPDU.

The NCC indicates per variant controlled transmission context type:

- The implicit protocol type that applies when not indicating the protocol type in the ALPDU. The NCC provides this indication in the Frame payload format descriptor.
- Whether to use compressed 1 byte or full 2 byte protocol type when including explicit protocol type indication in the ALPDU. This indication is given in the Frame payload format descriptor.

9.10.6 Essential Traffic Payload Structures

9.10.6.0 Introduction

Essential traffic payload structures for different transmission scenarios are defined in this clause.

9.10.6.1 Transparent Star

For transparent star the following payload structures has to be supported as a minimum:

- ALPDU label as per clause 7.2.1.2.
- Use of compressed protocol type.
- Use of the 1 byte sequence number specified in clause 7.2.1.1.6.
- PPDU label as per clause 7.2.2.10.
- Payload label as per clause 7.2.3.3.
- Implicit payload map.

Support for other traffic payload structures is considered optional.

9.10.6.2 Transparent Mesh

For transparent mesh overlay the following payload structures has to be supported as a minimum:

- ALPDU label as per clause 7.2.1.2.
- Use of compressed protocol type.
- Use of the 1 byte sequence number specified in clause 7.2.1.1.6.
- PPDU label as per clause 7.2.2.10.
- Payload label as per clause 7.2.3.3.
- Implicit payload map.

Support for other traffic payload structures is considered optional.

9.10.6.3 Regenerative Mesh

For regenerative mesh the following payload structures has to be supported as a minimum:

- ALPDU label as per clause 7.2.1.2.
- Use of compressed protocol type.
- Use of the 1 byte sequence number specified in clause 7.2.1.1.6.
- PPDU label as per clause 7.2.2.10.
- Payload label as per clause 7.2.3.3.
- Implicit payload map.

Support for other traffic payload structures is considered optional.

9.10.6.4 Transparent Star Continuous Transmission

With respect to label content, the "Transparent star continuous transmission" context is considered a variant of "transparent star dedicated access" context and shares that context with burst mode operation. For transparent star continuous transmission the following payload structures have to be supported as a minimum:

- ALPDU label as per clause 7.2.1.2.
- Use of compressed protocol type.
- Use of the 1 byte sequence number specified in clause 7.2.1.1.6.

- PPDU label as per clause 7.2.2.10.
- Payload label as per clause 7.2.3.3.
- Implicit payload map.

Support for other traffic payload structures is considered optional.

9.11 Return Link Status Supervision

The RCST shall, while logged on, transmit in every control timeslot assigned for dedicated access by the Control Assign Descriptor in the logon response TIM-U and in the TBTP2.

The RCST shall report updated forward link CNI estimate regularly while logged on. A CNI report shall follow each forward link MODCOD request.

The RCST may be provided with return link E_s/N_0 estimates from the NCC on a regular basis.

9.12 Remote Control of the RCST

9.12.0 Introduction

The RCST remote control features described in the following subsections are available via the lower layer signalling system.

9.12.1 Log Off

The RCST shall when instructed by the NCC to log off immediately cease transmission as specified in clause 9.2.1. The NCC may trigger a re-logon by issuing a wakeup instruction to the RCST.

9.12.2 Hold Transmission

The RCST shall immediately cease transmission and suspend any further transmission when instructed to hold transmission as specified in clause 9.2.1. The RCST shall abandon the hold state as instructed by the NCC.

The hold state shall be persistent and non-volatile as long as the RCST is assigned to the administrative entity that issued the instruction, until termination of the hold state is instructed. The hold state programmed by a TIM-U may be autonomously terminated by the RCST when it is assigned to another administrative entity as identified by the combination of NIT-ONID, RMT-INID and RMT-NCCID.

9.12.3 Wakeup

An operational RCST that is monitoring the allocated forward link shall if not in the hold state when commanded to wake up in a TIM-U take up normal operation on the network by logging on via the superframe sequence assigned via RMT.

9.12.4 Remote Echo

The RCST shall without unnecessary delay respond with the appropriate echo signature to a request for echoing a specific signature issued by the NCC. This shall be issued as an M&C Message in a Control PDU. An operational RCST that is not logged on and not in the hold state shall log on to issue the echo response.

9.12.5 SNMP Set to Remote (optional)

The RCST may support SNMP SET commands conveyed by the TIM-U in the Network Layer Info Descriptor. This allows unidirectional communication with an SNMP agent in the RCST independent of the presence and condition of another intermediate protocol stack.

9.12.6 CLI Instruction to Remote (optional)

The RCST may support vendor specific CLI commands issued via the CLI Instruction Descriptor sent in TIM-B and in TIM-U. This allows unidirectional communication with a script based control console of the RCST independent of the presence and condition of another intermediate protocol stack.

9.12.7 Network Failure and Recovery

TIM-B may indicate a diversity of network conditions that shall or may affect the operation of the RCST.

Conditions related to link failures:

- `Link_failure_recovery`: The RCST may follow a pre-defined procedure for large outage recovery until a new TIM-B is received where this condition is released.

The RCST shall proceed in the Hold/Standby state and stay there if this condition is indicated:

- `Return_link_failure`.

9.12.8 Rain Fade Indications

TIM-U may carry indications of the following rain fade related conditions:

- Indication of an on-going rain fade.
- Indication of restoring of non-rain-fade operation after cessation of rain fade adaptation.

9.13 Control of the MTU

The user traffic MTU to be used for the forward link may be explicitly indicated by the RCST in the logon request. The NCC may ignore indication of an MTU that is smaller than the default MTU. The feeder shall not issue SDUs larger than this MTU unless other administrative configuration takes precedence. If the NCC is not explicitly instructed about the specific MTU to use for the feeder it shall assume the default MTU.

The MTU to be used for the user traffic SDUs in the traffic timeslots in the return link may be explicitly indicated by the NCC in the logon response per virtual interface, or for the gateway in general when sent in TIM-B. The RCST may ignore indication of an MTU that is smaller than the default. The RCST shall not issue SDUs larger than this unless other administrative configuration takes precedence. The RCST shall assume the default MTU if it does not receive explicit instruction about the MTU to use.

9.14 Pointing Alignment Support

An RCST is installed for transmission under local control, possibly supported by pointing automation. The method for locally enabling the RCST for transmission is implementation dependent. The installation procedure may require verification of RX alignment before allowing transmission.

If the NCC indicates in the Pointing Alignment Support descriptor that the network supports automated alignment, the RCST may request this and shall then indicate all supported methods, for the NCC to choose. If the NCC indicates that it requires pointing alignment before allowing the RCST into the network, the RCST has to align if it is not already indicated to be aligned in the status indicated by the NCC in the logon response. Unless the RCST is administratively forced, the RCST shall not request for pointing alignment support at logon if an NCC, in the current interactive network and over the current satellite, does confirm that the RCST is properly aligned, and the current NCC continues to indicate this status at successive logon.

The RCST may send a pointing alignment request to the NCC. The RCST capabilities for doing pointing alignment, i.e. supported methods, shall be indicated in the pointing alignment request logon burst.

The NCC may send a pointing alignment instruction to the RCST in the logon response TIM-U upon the reception of a pointing alignment request, and will give a maximum duration for completing the pointing alignment procedure. If the procedure has not been completed with success before this maximum is reached, the RCST shall unconditionally terminate the procedure with failure. The NCC may during the procedure prolong the duration of the procedure by setting the remaining duration time to a desired value. The NCC may indicate capability for automated pointing alignment to make the RCST request for alignment through broadcasting the Pointing Alignment Support descriptor in TIM-B. The NCC may indicate the nominal clear sky SNR that the installer should measure when having the receiver antenna properly aligned. This may help the installer in deciding whether the coarse pointing alignment is sufficient before proceeding with return link transmission.

The RCST may be instructed to probe for pointing alignment by use of bursts. This is done by use of dedicated access logon timeslots and logon bursts tailored for the purpose. The NCC will provide the timeslots for this by a TBTP2 dedicated to logon. For the benefit of detection and measurement, the pointing alignment probe logon burst shall be sent with a pattern as instructed by the NCC. The RCST may be instructed to probe for pointing alignment by use of a CW of limited duration. The RCST shall start and terminate the CW transmission within 10 ms relative to the allowed transmission interval, with reference to the NCR acquired from the forward link. The CW transmission shall be executed once for each instruction received. TIM-U may provide several instructions constituting an unbroken CW transmission mapped to the frequency and time domain, and the RCST shall then transmit continuously as long as instructed, but within the maximum time limit of the pointing alignment procedure. Several instructions may be given in one TIM-U and there may be instructions given in several TIM-U's.

The NCC may force the RCST to rerun the pointing alignment procedure by indicating that the specific RCST is no longer considered aligned as indicated in the "RCST_access_status" field sent in the Logon Response descriptor in TIM-U. The procedure is associated with a maximum duration and shall expire with failure if not successful before expiry. The duration may be prolonged during the procedure.

The RCST shall terminate the procedure with failure if it receives a pointing alignment instruction that does not match with the supported methods, e.g. like being a constant power device and being instructed to set the EIRP to a certain level.

The NCC may indicate an alignment POPID that is different from the administratively assigned operational POPID. The RCST shall then acquire the forward link and return link for alignment via the start-up RMT, by taking on the indicated alignment POPID. The alignment POPID does only apply during the pointing alignment procedure. The RCST shall keep the acquired transmission timing advance in this process.

The NCC may at any time during alignment confirm that the RCST is aligned by indicating alignment success via the Pointing Alignment Support descriptor in TIM-U, and the RCST shall then immediately terminate the pointing alignment procedure and proceed according to the operational procedures specified in ETSI EN 301 790 [1]. It shall then use the POPID associated with normal operation, which may need reacquisition of the forward link. The NCC may also terminate the procedure immediately by indicating failure, or prolong the procedure in excess of the current maximum duration by setting the remaining procedure duration to the preferred value.

The logon burst that is used as alignment probe shall be encoded as follows:

- It shall explicitly indicate that it is a probe type logon burst by the entry type.
- It shall set all 4 access status flags to zero.
- It shall be filled with the alignment probe payload.

The alignment probe logon burst shall not be sent by random access.

9.15 M&C of the CC operation (Option)

An RCST supporting continuous carrier operation shall accept the CC Control Descriptor transmitted in TIM-U and shall support the relevant control features specified in the present document, according to CC capabilities indicated in the logon PDU, and the CC configuration and capabilities signalled by the NCC. The CC Control Descriptor is specified in clause 6.4.17.32. An RCST that indicates CC support shall silently discard each CC Control Descriptor of an unknown type or unsupported type, and act as applicable on known descriptors that may be present in the same TIM-U.

Return link control signalling specific to the continuous-carrier operation shall be carried in the return link using the "Continuous Carrier Message" Control PDU element type as defined in clause 8.3.2. This allows transport of requests and confirmations needed for the CC operation. The RCST shall not transmit a CC Control Message before having received a CC Control Descriptor from the NCC (implicitly indicating that the CC Control Element format is well-known to this NCC).

The RCST shall respond to reception of each CC Control Descriptor by issuing a CC control message in a Control PDU as follows:

- Carrier assignment => issue a response.
- Carrier revocation => issue release acknowledgement as in-band on CC before stopping CC Tx.
- CC mode configuration => issue a response.
- Time/frequency offset report request => issue an offset report as in-band on CC.
- Tx_type change => issue at least one tx_type change indication as response to this instruction.

The NCC may by CC mode configuration sent in the CC Control Descriptor explicitly allow the RCST the support of any of the following features:

- Request for carrier by requesting for a specific carrier type and a specific tx_type, using a CC Control Message as specified in table 8-22.
- Request for BoD with capacity requests as indicated in the Lower Layer Service Descriptor specified in clause 6.4.17.17, also when transmitting a continuous carrier.
- Transmit any type of information before receiving CC acquisition confirmation from the NCC.
- Conditional return directly to "Ready for TDMA Sync" state at expiration of non-persistent CC assignment that has neither been renewed nor superseded, refer to clause 9.2.8.
- Conditional return directly to "TDMA Sync" state at expiration of non-persistent CC assignment that has neither been renewed nor superseded, refer to clause 9.2.8.
- Split SDUs between TDMA and CC in the transitions between TDMA and CC.

10 Mobile Terminal Operation (optional)

10.0 Introduction

This clause defines requirements and protocols for use by RCSTs mounted on mobile platforms.

10.1 Mobility Management

10.1.0 Introduction

Mobility management encompasses handover of RCSTs between beams, gateways and satellites. Satellite handover always entails beam and gateway handover. Gateway handover always entails beam handover, but can take place within the same satellite delivery network. In the latter case the gateway handover may be transparent to the RCST in the sense that it appears functionally identical to a beam handover.

10.1.1 Beam Handover

Beam handover as defined in the present clause is effectuated within a single network.

Beam handover management shall rely on three distinct processes: handover detection/recommendation, handover decision and handover execution. They involve a number of events/activities taking place in RCST and NCC. Beam handover management can be based on either:

- a distributed approach, with the detection/recommendation taking place in RCST and the handover decision in NCC; or
- a centralized approach, in which the detection / recommendation is also carried out in the NCC.

The choice is system-dependent, and the RCST shall support both methods. The NCC shall in any case control the handover execution process.

NOTE 1: The NCC may derive the location of the RCST at log-on time (i.e. the return link transponder/beam) from the Superframe sequence ID - Beam_ID table in its database, using as entry the Superframe sequence ID of the acquired return link.

When the distributed approach is used, handover detection and recommendation is performed in accordance with the following steps:

- The RCST shall detect the need for handover and shall signal this by means of transmitting one or more Mobility_Control_Messages, containing handover requests and prioritized recommendations for target beams.
- Each handover request can refer to the forward link, the return link or to both. In situations where handover is requested for both links but these are operated through separate beams, individual requests for forward and return link handover shall be issued.
- The RCST shall attempt to transmit the initial handover request at least 10 seconds prior to the time at which it is predicted that the link would be lost without a handover.
- The RCST may send multiple copies of the set of handover requests until their receipt by the NCC is acknowledged (by the transmission of a TIM with the handover command, see below).
- The decision algorithm in the NCC shall accept multiple such handover recommendations from an RCST and respond with a unique handover decision.

When the centralized approach is used, the handover detection and recommendation is performed at the NCC:

- The NCC shall be capable of including the relevant signalling in the DVB-RCS tables distributed in the beam in which the RCST finds itself at a given time. In particular, the NCC shall be capable of generating and transmitting a TIM in the current beam with information pertinent to the resources in the target beam.
- The handover execution shall start with the transmission of the handover command to RCST, together with all the information needed for operation in the target beam.
- The NCC shall transmit all information needed for operation in the target beam while the RCST is still operating in the current beam. This includes the distribution of the descriptions of all relevant forward and return links.
- The handover command and all the information related to the target beam shall be sent by using a unicast TIM with the following descriptors:
 - Mobility Control Descriptor, including the relevant handover command(s).
 - Satellite Forward Link Descriptor, containing the new beam ID and the physical characteristics (frequency, polarization, modulation/coding) of the new forward link.
 - Satellite Return Link Descriptor, containing the new beam ID and new Superframe sequence ID with the associated Tx Frequency Offset.
 - Control Assign descriptor, which gives the location (i.e. slot number), frame and start superframe of a new static control slot assignment (applicable to the new frame structure), together with the repeat period. This is not required if control slots are assigned through TBTP2.
 - Logon response descriptor, containing the new Group ID, Logon ID.

NOTE 2: The new Superframe sequence ID is associated with a new frame structure, defined by the composition tables corresponding to the new beam/transponder.

- Upon the reception of the handover command the RCST shall extract and store the information needed for operation in the target beam.
- The RCST shall be capable of handling multiple sets of tables, physical and logical resources (corresponding to different beams) and of switching from one set to another as triggered by pre-defined events.
- The RCST synchronization scheme shall be capable of coping with discontinuities in NCR distribution during handover.
- The RCST shall acquire burst synchronization in the target beam by using the DVB-RCS mechanisms (including the use of control bursts and CMT replies).
- After the transmission of the handover command and during the acquisition by the RCST of the forward and return synchronization in the target beam, the NCC shall stop forwarding traffic and signalling to the RCST.
- After activating the composition tables for the target beam, the RCST shall cease sending control bursts to the old beam.
- An RCST in a logged-off state may send a logon burst with the entry type code corresponding to a location update. Reception of such a burst shall not in itself cause the NCC to initiate a logon process.

10.1.2 Satellite/Gateway Handover

Handovers among gateways belonging to the same network and under control of the same NCC may be made to appear to the RCST in the same manner as beam handovers.

Handovers involving multiple NCCs are outside the scope of the present document. Handovers between satellites at different orbit locations involve many system- and technology dependent aspects.

The recommended technique for all these types of handover is to log off the source network and subsequently log on to the target network.

10.2 Interference Avoidance

10.2.0 Introduction

The mobile RCST shall comply with the requirements for the Control and Monitoring Functions (CMF) specified in the applicable regulatory documents. These depend on the frequency band, regulatory authority and the type of platform on which the RCST is mounted. In Europe and certain other places, the technical basis for the regulatory provisions are defined by ETSI. For aeronautical, maritime and land mobile stations in Ku-band, the applicable provisions are defined in ETSI EN 302 186 [i.22], ETSI EN 302 340 [i.23], ETSI EN 302 448 [i.24] and ETSI EN 302 977 [i.25], covering the essential requirements under article 3.2 of the R&TTE directive. Article 3.2 concerns the use of spectrum under the R&TTE Directive [i.19]. Also in Ku-band, specified in FCC Part 25-Satellite Communications, § 25.222 [i.26] is applicable in the United States of America and Recommendation ITU-R M.1643 [i.20] is applicable world-wide. Equivalent provisions for Ka-band in Europe and certain other places are given in ETSI EN 303 978 [i.28].

To the extent they are within the scope of the present standard, the sub-clauses below specify the minimum functionality required to meet the stated CMF requirements, to control interference and otherwise faulty operation for:

- off-axis EIRP emission density into adjacent FSS satellites;
- power flux density of received interference signal at specified terrestrial stations;
- fault conditions.

10.2.1 Off-Axis EIRP Emission Density

The NCC shall control the level of off-axis EIRP emission density to comply with the applicable regulatory requirements by adjusting the corresponding on-axis EIRP density level. In order to permit the NCC to determine permissible transmit levels, the RCST shall support the Mobility_Control_Message and the Mobility Control descriptor in the unicast TIM. When requested, the RCST shall send the Transmission Status Report form of the Mobility_Control_Message at the earliest opportunity.

10.2.2 Power Flux Density at the Surface of the Earth

The NCC shall control the mobile terminal EIRP density to ensure that the received power flux density at the earth stations of the FS, RAS, SRS and any other applicable services does not exceed the relevant limits prescribed by regulation.

The RCST shall be able to determine when such interference may occur in the near future. Upon detecting this situation, the RCST shall send the Exclusion Zone Entry form of the Mobility_Control_Message control PDU at the earliest opportunity. This message shall be sent at least twice.

The Mobility_Control_Message may contain a request for a particular type of remedial action to avoid harmful interference. The decision shall be taken and implemented by the NCC. Possible remedial actions include:

- Log off (cease transmission).
- Change frequency to a band with no or less restrictive limits.
- Change transmission parameters to comply with limits.

If the RCST is forced to log off/cease transmission in response to the transmission of the Exclusion Zone Entry form of the Mobility_Control_Message, it shall not resume transmission until it has determined that it has left the exclusion zone.

10.2.3 Fault Conditions

The NCC shall periodically monitor and detect any fault conditions that may lead to malfunction of normal operation, including faults that result in both intra-system and intersystem interference, and shall take appropriate remedial actions. The fault conditions shall include the general requirements specified in applicable regulatory documents.

11 Security

Security aspects relevant for the present document are addressed in ETSI TS 101 545-1 [i.15].

The present document supports the following elements for implementation of a security system:

- a) Protocol identifiers for support of security system protocols.
- b) Signal identifiers for support of security system signals.
- c) Optional authentication of the user when connecting an RCST to the network.

A number of security considerations apply inherently to the present document:

- a) The optional Command Line Interface (CLI) Instruction descriptor may constitute a signal that supports unauthorized manipulation of the configuration of an RCST from an entity that is able to connect via the lower layer signalling via the satellite interface.
- b) The Network Layer Information descriptor may constitute a signal that supports unauthorized manipulation of the configuration of an RCST from an entity that is able to connect via the lower layer signalling via the satellite interface.
- c) Position reports by mobile RCSTs may be sensitive.

These aspects should be considered when implementing support of these descriptors.

Annex A (normative): Reference waveforms

The index "Waveform Id" associated with the reference waveforms is used within the context of each transmission format class. It may be directly referenced by the BCT. Values in the range 0-127 are reserved for specification of reference waveforms for the standardized transmission format classes. Values in the range 128-256 are reserved for user defined waveforms that may be loaded to the RCST in advance. All values are reserved for user defined waveforms when used for a user defined transmission format class.

An RCST shall have preloaded the specification of all normative reference waveforms that apply to the supported terminal profile types loaded in advance, for reference by the waveform_id as specified in clause 6.4.6.

Table A-1 lists the reference waveforms for linear modulation format class bursts. The parameters follow the syntax specified in clause 6.4.6.1.

Table A-2 lists the reference waveforms for linear modulation spread-spectrum format class bursts. The parameters follow the syntax specified in clause 6.4.6.4.

Table A-3 lists the reference waveforms for continuous phase modulation format class bursts. The parameters follow the syntax specified in clause 6.4.6.2.

Tables A-4 and A-5 list the reference waveforms for optional continuous carrier transmission. The corresponding parameter block is specified in clause 6.4.6.3.

The units that apply for the values for the different parameters are the same as those that apply for the programming syntax for the respective parameters, with specifications to be found in the respective clauses.

Table A-1: Reference Waveforms for Linear Modulation Bursts

Waveform Id	Burst Length	Payload length (bytes; symbols)	Mapping scheme	Code Rate	Pre-amble length	Post-amble length	Pilot Period	Pilot block	Pilot sum	P	Q0	Q1	Q2	Q3	First parity bit Y puncture		Second parity bit W puncture		UW (hex)
															Period	Pattern	Period	Pattern	
1	664	38; 456	QPSK	1/3	155	27	18	1	26	17	9	5	14	1	1	1	1	1	3300FC0FF3 C33CCFFF03 00C0FCF300 CCCCCF0CF FC3C3F00CF CC0F33FF0C C0F00F030F 330CFFF00F 030F330CFF F00

Waveform Id	Burst Length	Payload length (bytes; symbols)	Mapping scheme	Code Rate	Pre-ambble length	Post-ambble length	Pilot Period	Pilot block	Pilot sum	P	Q0	Q1	Q2	Q3	First parity bit Y puncture		Second parity bit W puncture		UW (hex)
															Period	Pattern	Period	Pattern	
2	262	14; 168	QPSK	1/3	41	41	15	1	12	9	2	2	8	0	1	1	1	1	3CF0003F0F 30CCCCFCFF C03CF0003F 0F30CCCCFC FFC0
3	536	38; 456	QPSK	1/3	27	27	18	1	26	17	9	5	14	1	1	1	1	1	F030F330CF FF00F030F33 0CFFF00
4	536	59; 472	QPSK	1/2	22	22	24	1	20	23	10	2	11	1	1	1	1	0	C300FCC33F C30C03F30C FF0
5	536	85; 510	QPSK	2/3	13	13	0	1	0	23	6	13	10	0	2	10	1	0	F30303FCC0 C0F
6	536	96; 512	QPSK	3/4	12	12	0	1	0	25	1	2	0	1	6	101000	1	0	3FCC303FCC 30
7	536	108; 519	QPSK	5/6	9	8	0	1	0	29	1	4	1	1	20	100010 001000 100000 00	1	0	C033CCFC0
8	536	115; 460	8PSK	2/3	10	9	9	1	57	29	6	5	0	0	2	10	1	0	DB0C060060 00C36
9	536	130; 463	8PSK	3/4	8	8	9	1	57	31	0	1	2	0	6	101000	1	0	186D80030D B00
10	536	144; 462	8PSK	5/6	9	8	9	1	57	31	0	0	0	0	20	100010 001000 100000 00	1	0	C00186C061 B600
11	536	175; 467	16QAM	3/4	9	9	10	1	51	37	0	2	0	2	6	101000	1	0	4EEEE4E44E 4EEEE4E44
12	536	194; 466	16QAM	5/6	10	9	10	1	51	39	7	0	0	0	20	100010 001000 100000 00	1	0	444E4EE4EE E4EEEE4E44
13	1 616	123; 1 476	QPSK	1/3	32	31	20	1	77	31	0	3	1	0	1	1	1	1	3F00C30F3F 3FCCC03CC 0F03F3F0033 3C

Waveform Id	Burst Length	Payload length (bytes; symbols)	Mapping scheme	Code Rate	Pre-ambble length	Post-ambble length	Pilot Period	Pilot block	Pilot sum	P	Q0	Q1	Q2	Q3	First parity bit Y puncture		Second parity bit W puncture		UW (hex)
															Period	Pattern	Period	Pattern	
14	1 616	188; 1 504	QPSK	1/2	25	25	25	1	62	37	1	3	4	2	1	1	1	0	FC033FCC30 30CFC033FC C30303
15	1 616	264; 1 584	QPSK	2/3	16	16	0	1	0	43	0	0	6	2	2	10	1	0	CCC3F00FC CC3F00F
16	1 616	298; 1 590	QPSK	3/4	13	13	0	1	0	49	0	3	5	0	6	101000	1	0	F30303FCC0 C0F
17	1 616	333; 1 599	QPSK	5/6	9	8	0	1	0	49	0	5	0	5	20	100010 001000 100000 00	1	0	C033CCFC0
18	1 616	355; 1 420	8PSK	2/3	10	9	9	1	17 7	53	1	4	6	2	2	10	1	0	DB0C060060 00C36
19	1 616	400; 1 423	8PSK	3/4	8	8	9	1	17 7	53	1	10	7	1	6	101000	1	0	186D80030D B00
20	1 616	444; 1 422	8PSK	5/6	9	8	9	1	17 7	59	3	8	5	1	20	100010 001000 100000 00	1	0	C00186C061 B600
21	1 616	539; 1438	16QAM	3/4	10	9	10	1	15 9	65	0	3	7	0	6	101000	1	0	444E4EE4EE E4EEEE4E44
22	1 616	599; 1 438	16QAM	5/6	10	9	10	1	15 9	81	1	2	5	2	20	100010 001000 100000 00	1	0	444E4EE4EE E4EEEE4E44
32	832	100; 800	QPSK	1/2	32	0	0	0	0	23	10	8	2	1	1	1	1	0	0C330C0FF3 F3033F
33	566	100; 534	QPSK	3/4	32	0	0	0	0	23	10	8	2	1	6	101000	1	0	0C330C0FF3 F3033F
34	1 392	170; 1 360	QPSK	1/2	32	0	0	0	0	33	9	15	3	1	1	1	1	0	0C330C0FF3 F3033F
35	939	170; 907	QPSK	3/4	32	0	0	0	0	33	9	15	3	1	6	101000	1	0	0C330C0FF3 F3033F

Waveform Id	Burst Length	Payload length (bytes; symbols)	Mapping scheme	Code Rate	Pre-ambble length	Post-ambble length	Pilot Period	Pilot block	Pilot sum	P	Q0	Q1	Q2	Q3	First parity bit Y puncture		Second parity bit W puncture		UW (hex)
															Period	Pattern	Period	Pattern	
36	810	170; 778	QPSK	7/8	32	0	0	0	0	33	9	15	3	1	28	100010 000000 100000 001000 0000	1	0	0C330C0FF3 F3033F
37	2660	438; 2 628	QPSK	2/3	32	0	0	0	0	59	1	1	2	1	2	10	1	0	0C330C0FF3 F3033F
38	2222	438; 2 190	QPSK	4/5	32	0	0	0	0	59	1	1	2	1	4	1000	1	0	0C330C0FF3 F3033F
39	2076	438; 2 044	QPSK	6/7	32	0	0	0	0	59	1	1	2	1	12	100010 000000	1	0	0C330C0FF3 F3033F
40	1868	59; 1 416	BPSK	1/3	313	56	18	1	83	23	10	2	11	1	1	1	1	1	BB8874877B 4BB447778B 8848747B884 4444784774B 4B788474487 BB778448788 37108FD0959 72F1BA7E72 74340AB0
41	1612	59; 1 416	BPSK	1/3	57	56	18	1	83	23	10	2	11	1	1	1	1	1	37108FD0959 72F1BA7E72 74340AB0
42	3236	123; 2 952	BPSK	1/3	65	64	20	1	15 5	31	0	3	1	0	1	1	1	1	C7B6676A0A 09D0B7B17D 422B7B8E48 E44
43	3236	188; 3 008	BPSK	1/2	52	51	25	1	12 5	37	1	3	4	2	1	1	1	0	DFCCD0A17 58493B4728 DC5828F
44	266	51; 245	QPSK	5/6	11	10	-	-	0	23	10	5	0	0	20	100010 001000 100000 00	1	0	CFCF03F30C 0
45	266	55; 220	8-PSK	2/3	10	9	9	1	27	23	6	10	4	0	2	10	1	0	DB0C060060 00C36
46	266	62; 221	8-PSK	3/4	9	9	9	1	27	23	6	8	1	1	6	101000	1	0	C00186C300 061B0

Waveform Id	Burst Length	Payload length (bytes; symbols)	Mapping scheme	Code Rate	Pre-ambble length	Post-ambble length	Pilot Period	Pilot block	Pilot sum	P	Q0	Q1	Q2	Q3	First parity bit Y puncture		Second parity bit W puncture		UW (hex)
															Period	Pattern	Period	Pattern	
47	266	69; 222	8-PSK	5/6	9	8	9	1	27	25	1	1	2	0	20	100010 001000 100000 00	1	0	C00186C061 B600
48	266	84; 224	16-QAM	3/4	9	9	10	1	24	23	8	1	4	1	6	101000	1	0	4EEEE4E44E 4EEEE4E44
49	266	93; 224	16-QAM	5/6	9	9	10	1	24	25	1	7	2	1	20	100010 001000 100000 00	1	0	4EEEE4E44E 4EEEE4E44

Table A-2: Reference Waveforms for Spread-spectrum Linear Modulation Bursts

Waveform ID	Burst Length (symbols)	Spreading factor	Burst Length (chips)	Payload length (bytes)	Payload length (symbols)	Mapping Scheme	Pre-ambble length (chips)	Post-ambble length (chips)	Pilot Period (chips)	Pilot Block (chips)	Pilot sum (chips)	P	Q0	Q1	Q2	Q3	First parity bit Y puncture		Second parity bit W puncture		UW (hex)
																	Period	Pattern	Period	Pattern	
1	1 792	2	3 584	100	1 600	BPSK	6	0	56	6	378	23	10	8	2	1	1	1	1	0	9A6
2	1 344	2	2 688	100	1 200	BPSK	6	0	56	6	282	23	10	8	2	1	2	10	1	0	9A6
3	3 047	2	6 094	170	2 720	BPSK	6	0	56	6	648	33	9	15	3	1	1	1	1	0	9A6
4	2 198	2	4 396	170	2 040	BPSK	4	0	56	4	312	33	9	15	3	1	2	10	1	0	99
5	7 548	2	15 096	438	7 008	BPSK	4	0	56	4	1 076	59	1	1	2	1	1	1	1	0	99
6	5 662	2	11 324	438	5 256	BPSK	4	0	56	4	808	59	1	1	2	1	2	10	1	0	99
7	1 792	4	7 168	100	1 600	BPSK	12	0	112	12	756	23	10	8	2	1	1	1	1	0	9AF9AF
8	1 344	4	5 376	100	1 200	BPSK	12	0	112	12	564	23	10	8	2	1	2	10	1	0	9AF9AF
9	3 047	4	12 188	170	2 720	BPSK	12	0	112	12	1 296	33	9	15	3	1	1	1	1	0	9AF9AF
10	2 198	4	8 792	170	2 040	BPSK	8	0	112	8	624	33	9	15	3	1	2	10	1	0	9A9A
11	7 548	4	30 192	438	7 008	BPSK	8	0	112	8	2 152	59	1	1	2	1	1	1	1	0	9A9A
12	5 662	4	22 648	438	5 256	BPSK	8	0	112	8	1 616	59	1	1	2	1	2	10	1	0	9A9A

Waveform ID	Burst Length (symbols)	Spreading factor	Burst Length (chips)	Payload length (bytes)	Payload length (symbols)	Mapping Scheme	Pre-amble length (chips)	Post-amble length (chips)	Pilot Period (chips)	Pilot Block (chips)	Pilot sum (chips)	P	Q0	Q1	Q2	Q3	First parity bit Y puncture		Second parity bit W puncture		UW (hex)
																	Period	Pattern	Period	Pattern	
13	1 792	8	14 336	100	1 600	BPSK	24	0	224	24	1 512	23	10	8	2	1	1	1	1	0	9AFF499AFF49
14	1 344	8	10 752	100	1 200	BPSK	24	0	224	24	1 128	23	10	8	2	1	2	1 0	1	0	9AFF499AFF49
15	3 047	8	24 376	170	2 720	BPSK	24	0	224	24	2 592	33	9	15	3	1	1	1	1	0	9AFF499AFF49
16	2 198	8	17 584	170	2 040	BPSK	16	0	224	16	1 248	33	9	15	3	1	2	1 0	1	0	9AFF9AFF
17	7 548	8	60 384	438	7 008	BPSK	16	0	224	16	4 304	59	1	1	2	1	1	1	1	0	9AFF9AFF
18	5 662	8	45 296	438	5 256	BPSK	16	0	224	16	3 232	59	1	1	2	1	2	1 0	1	0	9AFF9AFF
19	1 419	16	22 704	38	608	BPSK	8	0	14	8	12 968	59	1	1	2	1	1	1	1	0	9A9A

Table A-3: Reference Waveforms for Continuous Phase Modulation Bursts

Waveform id	FEC input bit length	FEC output bit length	Preamble bit length	Data #1 bit length	Trellis termination bits	Midamble bit length	Data #2 bit length	Trellis termination bits	Burst symbol length	Alphabet size(M)	Modulation index(h)	Code rate	CC type	Carrier Spacing	Spectral Efficiency b/s/Hz	Memory length (L)	UW (Preamble+Midamble)	Phase Response
1	454	912	64	64	6	64	848	6	526	4	2/5	1/2	(5,7) _o	2.0	0.5	2	7CD593ADF7818AC8	AV α _{RC} =0.98
2	166	336	64	64	6	64	272	6	238	4	2/5	1/2	(5,7) _o	2.0	0,5	2	7CD593ADF7818AC8	AV α _{RC} =0,98
3	400	804	64	64	6	64	740	6	472	4	2/5	1/2	(5,7) _o	2.0	0,5	2	7CD593ADF7818AC8	AV α _{RC} =0,98
4	400	804	64	64	4	64	740	4	470	4	1/3	1/2	(5,7) _o	1,333	0,75	2	7CD593ADF7818AC8	AV α _{RC} =0,75
5	400	603	64	64	6	64	539	6	372	4	2/7	2/3	(5,7) _o	1,21	1,1	2	7CD593ADF7818AC8	AV α _{RC} =0,75
6	400	603	64	64	6	64	539	6	372	4	2/7	2/3	(5,7) _o	1,067	1,25	2	7CD593ADF7818AC8	AV α _{RC} =0,75
7	400	504	64	64	4	64	440	4	320	4	1/4	4/5	(15,17) _o	1,0667	1,5	2	7CD593ADF7818AC8	AV α _{RC} =0,75

Waveform id	FEC input bit length	FEC output bit length	Preamble bit length	Data #1 bit length	Trellis termination bits	Midamble bit length	Data #2 bit length	Trellis termination bits	Burst symbol length	Alphabet size(M)	Modulation index(h)	Code rate	CC type	Carrier Spacing	Spectral Efficiency b/s/Hz	Memory length (L)	UW (Preamble+Midamble)	Phase Response
8	400	471	64	64	6	64	407	6	306	4	1/5	6/7	(15,17) _o	0,974	1,8	2	7CD593ADF7818AC8	AV $\alpha_{RC}=0,625$
9	1 024	2 052	64	64	6	64	1 988	6	1 096	4	2/5	1/2	(5,7) _o	2,0	0,5	2	7CD593ADF7818AC8	AV $\alpha_{RC}=0,98$
10	1 024	2 052	64	64	4	64	1 988	4	1 094	4	1/3	1/2	(5,7) _o	1,333	0,75	2	7CD593ADF7818AC8	AV $\alpha_{RC}=0,75$
11	1 024	1 539	64	64	6	64	1 475	6	840	4	2/7	2/3	(5,7) _o	1,21	1,1	2	7CD593ADF7818AC8	AV $\alpha_{RC}=0,75$
12	1 024	1 539	64	64	6	64	1 475	6	840	4	2/7	2/3	(5,7) _o	1,067	1,25	2	7CD593ADF7818AC8	AV $\alpha_{RC}=0,75$
13	1 024	1 284	64	64	4	64	1 220	4	710	4	1/4	4/5	(15,17) _o	1,0667	1,5	2	7CD593ADF7818AC8	AV $\alpha_{RC}=0,75$
14	1 025	1 200	64	64	6	64	1 136	6	670	4	1/5	6/7	(15,17) _o	0,974	1,8	2	7CD593ADF7818AC8	AV $\alpha_{RC}=0,625$
15	1 504	3 012	64	64	6	64	2 948	6	1 576	4	2/5	1/2	(5,7) _o	2,0	0,5	2	7CD593ADF7818AC8	AV $\alpha_{RC}=0,98$
16	1 504	3 012	64	64	4	64	2 948	4	1 574	4	1/3	1/2	(5,7) _o	1,333	0,75	2	7CD593ADF7818AC8	AV $\alpha_{RC}=0,75$
17	1 504	2 259	64	64	6	64	2 195	6	1 200	4	2/7	2/3	(5,7) _o	1,21	1,1	2	7CD593ADF7818AC8	AV $\alpha_{RC}=0,75$
18	1 504	2 259	64	64	6	64	2 195	6	1 200	4	2/7	2/3	(5,7) _o	1,067	1,25	2	7CD593ADF7818AC8	AV $\alpha_{RC}=0,75$
19	1 504	1 884	64	64	4	64	1 820	4	1 010	4	1/4	4/5	(15,17) _o	1,0667	1,5	2	7CD593ADF7818AC8	AV $\alpha_{RC}=0,75$
20	1 504	1 759	64	64	6	64	1 695	6	950	4	1/5	6/7	(15,17) _o	0,974	1,8	2	7CD593ADF7818AC8	AV $\alpha_{RC}=0,625$

Table A-4: Reference Waveforms for Continuous Carrier Transmission, for the enhanced option (including 16QAM)

Waveform ID	Spreading factor	Frame Length (chips)	Payload length (bytes)	Blocks/frame	Mapping Scheme	Pre-amble length (chips)	Post-amble length (chips)	Pilot Period (chips)	Pilot Block (chips)	Padding chips	Pilot sum (chips)	Scramble polynomial (hex)	Scramble initialize (hex)	P	Q0	Q1	Q2	Q3	First parity bit Y puncture		Second parity bit W puncture		UW (hex)		
																			Period	Pattern	Period	Pattern			
1	8	30800	128	1	BPSK	128	0	240	48	0	6096	4001	FFFF	31	1	1	2	1	1	1	1	1	1D8A5F42DE72B306D7464 4049A7B87FFFFFFFFFFFFFFF		
2	8	30800	192	1	BPSK	128	0	240	48	0	6096	4001	FFFF	37	6	1	15	0	1	1	1	0	1D8A5F42DE72B306D7464 4049A7B87FFFFFFFFFFFFFFF		
3	4	30800	128	2	BPSK	128	0	240	48	0	6096	4001	FFFF	31	1	1	2	1	1	1	1	1	1D8A5F42DE72B306D7464 4049A7B87FFFFFFFFFFFFFFF		
4	4	30800	192	2	BPSK	128	0	240	48	0	6096	4001	FFFF	37	6	1	15	0	1	1	1	0	1D8A5F42DE72B306D7464 4049A7B87FFFFFFFFFFFFFFF		
5	2	30800	128	4	BPSK	128	0	240	48	0	6096	4001	FFFF	31	1	1	2	1	1	1	1	1	1D8A5F42DE72B306D7464 4049A7B87FFFFFFFFFFFFFFF		
6	2	30800	192	4	BPSK	128	0	240	48	0	6096	4001	FFFF	37	6	1	15	0	1	1	1	0	1D8A5F42DE72B306D7464 4049A7B87FFFFFFFFFFFFFFF		
7	1	30800	128	8	BPSK	128	0	240	48	0	6096	4001	FFFF	31	1	1	2	1	1	1	1	1	1D8A5F42DE72B306D7464 4049A7B87FFFFFFFFFFFFFFF		
8	1	30800	192	8	BPSK	128	0	240	48	0	6096	4001	FFFF	37	6	1	15	0	1	1	1	0	1D8A5F42DE72B306D7464 4049A7B87FFFFFFFFFFFFFFF		
9	1	30800	256	8	BPSK	128	0	240	48	0	6096	4001	FFFF	45	1	1	4	0	2	1	0	1	0	1D8A5F42DE72B306D7464 4049A7B87FFFFFFFFFFFFFFF	
10	2	6932	128	1	BPSK	32	0	108	12	0	756	4001	FFFF	31	1	1	2	1	1	1	1	1	1	3CFA84E4FFF	
11	2	6932	192	1	BPSK	32	0	108	12	0	756	4001	FFFF	37	6	1	15	0	1	1	1	0	3CFA84E4FFF		
12	1	6932	128	2	BPSK	32	0	108	12	0	756	4001	FFFF	31	1	1	2	1	1	1	1	1	1	3CFA84E4FFF	
13	1	6932	192	2	BPSK	32	0	108	12	0	756	4001	FFFF	37	6	1	15	0	1	1	1	1	0	3CFA84E4FFF	
14	1	6932	128	4	QPSK	32	0	108	12	0	756	4001	FFFF	31	1	1	2	1	1	1	1	1	1	3CFA84E4FFF	
15	1	6932	192	4	QPSK	32	0	108	12	0	756	4001	FFFF	37	6	1	15	0	1	1	1	1	0	3CFA84E4FFF	
16	1	6932	256	4	QPSK	32	0	108	12	0	756	4001	FFFF	45	1	1	4	0	2	1	0	1	0	3CFA84E4FFF	
17	1	6932	307	4	QPSK	32	0	108	12	4	756	4001	FFFF	49	0	6	0	1	4	1	0	0	1	0	3CFA84E4FFF
18	1	6932	256	6	8PSK	32	0	108	12	0	756	4001	FFFF	45	1	1	4	0	2	1	0	1	0	3CFA84E4FFF	
19	1	6932	307	6	8PSK	32	0	108	12	0	756	4001	FFFF	49	0	6	0	1	4	1	0	0	1	0	3CFA84E4FFF
20	1	6932	307	8	16QAM	32	0	108	12	0	756	4001	FFFF	49	0	6	0	1	4	1	0	0	1	0	3CFA84E4FFF

Table A-5: Reference Waveforms for Continuous Carrier Transmission, for the basic option, including waveforms for 16QAM

Waveform Id	Frame Length (symbols)	Payload length (bytes; symbols)	Mapping scheme	Code Rate	Pre-amble length	Pilot Period	Pilot block	Pilot sum	P	Q0	Q1	Q2	Q3	First parity bit Y puncture		Second parity bit W puncture		UW (hex)
														Period	Pattern	Period	Pattern	
21	3 172	123; 2 952	BPSK	1/3	65	20	1	155	31	0	3	1	0	1	1	1	1	C7B6676A0A09D0B7B17D4 22B7B8E48E44
22	3 185	188; 3 008	BPSK	1/2	52	25	1	125	37	1	3	4	2	1	1	1	0	DFCCD0A1758493B4728D C5828F
23	1 585	123; 1 476	QPSK	1/3	32	20	1	77	31	0	3	1	0	1	1	1	1	3F00C30F3F3FCCC03CC0 F03F3F00333C
24	1 591	188; 1 504	QPSK	1/2	25	25	1	62	37	1	3	4	2	1	1	1	0	FC033FCC3030CFC033FC C30303
25	1 600	264; 1 584	QPSK	2/3	16	0	1	0	43	0	0	6	2	2	10	1	0	CCC3F00FCCC3F00F
26	1 603	298; 1 590	QPSK	3/4	13	0	1	0	49	0	3	5	0	6	101000	1	0	F30303FCC0C0F
27	1 608	333; 1 599	QPSK	5/6	9	0	1	0	49	0	5	0	5	20	1000100010 0010000000	1	0	C033CCFC0
28	1 607	355; 1 420	8PSK	2/3	10	9	1	177	53	1	4	6	2	2	10	1	0	DB0C06006000C36
29	1 608	400; 1 423	8PSK	3/4	8	9	1	177	53	1	10	7	1	6	101000	1	0	186D80030DB00
30	1 608	444; 1 422	8PSK	5/6	9	9	1	177	59	3	8	5	1	20	1000100010 0010000000	1	0	C00186C061B600
31	1 607	539; 1 438	16QAM	3/4	10	10	1	159	65	0	3	7	0	6	101000	1	0	444E4EE4EEE4EEEE4E44
32	1 607	599; 1 438	16QAM	5/6	10	10	1	159	81	1	2	5	2	20	1000100010 0010000000	1	0	444E4EE4EEE4EEEE4E44

Annex B (normative): Interleaver Permutations for CC-CPM

The interleaver permutations are here listed for different blocklengths (N). For example, when $N = 504$ $\pi(0) = 293, \dots, \pi(6) = 19, \dots, \pi(N-1) = 89$ referring to clause 7.3.6.2.3.

Table B-1: N = 336

156	145	332	198	11	239	22	249	279	290	170	48	264	186	37	305	319	77	130	21	51	62	280	223	238	25	212	78	227	119
104	129	159	172	50	331	144	133	253	185	335	293	10	237	267	278	160	36	118	174	92	294	307	65	320	9	39	52	268	
211	24	13	200	66	215	107	226	117	147	158	38	252	132	54	241	173	187	281	334	225	255	266	148	91	80	282	229		
199	323	106	40	27	95	308	333	254	121	53	1	240	161	12	146	135	203	214	105	28	296	162	42	79	269	322	256	243	
175	188	213	136	68	270	217	120	311	228	26	15	83	94	321	242	109	41	258	295	149	0	134	123	55	202	93	16	284	150
30	67	191	310	244	231	163	176	201	122	325	257	205	108	299	216	14	3	71	82	309	230	4	283	56	111	97	190	137	
29	246	81	43	124	110	324	164	219	272	298	179	138	85	189	287	232	220	96	70	327	313	204	17	245	126	297	259		
2	326	271	44	99	152	178	59	18	234	69	31	112	98	312	286	207	193	84	167	125	73	177	275	218	208	151	260	315	301
58	5	233	114	285	247	328	314	192	32	87	140	166	47	6	289	57	155	100	274	72	127	206	88	330	221	165	181	195	
113	300	248	46	235	316	194	102	263	273	20	303	222	139	154	288	143	86	302	277	35	45	61	75	329	180	128	262		
115	196	76	318	209	153	169	183	101	19	236	34	23	304	182	157	251	261	8	291	210	60	142	276	131	74	292	265		
89	33	49	63	317	168	116	250	103	184	64	306	197	141	224	171	90	7												

Table B-2: N = 471

NOTE: The interleaver permutations for $N = 471$ are obtained by first computing the interleaver permutations for $N = 468$ and then inserting $\pi(21) = 470, \pi(121) = 469, \pi(221) = 468. \pi(21) = 470, \pi(121) = 469, \pi(221) = 468.$

374	169	5	160	344	25	70	259	419	393	120	185	206	1	46	460	176	325	370	91	251	470	235	420	17	38	301	346	292
8	157	202	391	83	67	252	317	338	133	178	124	308	457	34	223	383	367	84	149	170	433	269	384	140	339	364		
294	225	189	155	210	2	315	101	216	440	171	196	126	57	21	455	42	302	147	401	48	272	3	28	426	357	321	287	
342	134	447	233	348	104	303	328	258	179	153	119	174	434	229	274	220	404	85	130	319	11	453	180	245	266			
61	106	52	236	385	430	151	311	295	12	77	469	98	361	406	352	68	217	262	451	143	127	312	377	398	193	238	184	
368	49	94	283	443	427	144	438	329	444	75	270	399	230	249	285	200	424	354	215	161	276	375	102	231	62	81		
117	32	256	186	47	461	108	207	402	63	362	381	417	332	88	18	347	293	448	39	234	363	194	213	239	164	388	318	
408	334	280	289	305	145	26	55	71	464	190	379	240	166	112	121	137	445	326	355	371	296	22	211	72	466	412		
421	468	437	277	158	187	203	128	322	43	372	298	244	253	30	109	458	19	45	428	154	343	204	389	36	135	330		
459	290	309	345	260	16	414	275	336	435	107	92	246	141	122	177	291	316	221	162	168	267	407	392	78	441			
422	9	123	148	53	462	0	65	418	299	353	254	423	40	99	378	224	273	300	365	250	131	394	86	205	340	349	439	
56	115	132	197	82	431	226	386	37	172	181	271	356	415	432	29	382	263	58	218	337	4	13	103	188	247	35	90	214
105	358	50	219	264	313	403	20	79	335	390	76	405	449	350	51	96	195	6	320	369	167	222	376	237	281	182	351	

396 27 306 152 201 467 54 208 69 113 14 183 228 327 138 452 33 60 125 10 359 413 314 15 100 159 199 284 333
 360 425 310 191 454 146 265 400 409 31 116 175 142 446 416 7 192 241 97 331 286 23 232 257 442 278 248
 307 24 73 397 163 118 323 64 89 304 110 80 139 95 373 279 463 209 165 324 150 136 410 380 429 395 255 111
 66 41 465 156 450 436 242 212 261 227 87 411 366 341 297 456 282 268 74 44 93 59 387 243 198 173 129 288
 114

Table B-3: N = 504

293 325 372 104 171 438 19 467 350 154 208 237 70 121 482 366 357 215 319 244 336 454 99 185 389 421
 278 200 267 30 115 59 446 212 304 333 166 217 264 462 453 311 415 359 432 46 195 281 485 13 374 296 363
 107 211 136 38 308 400 429 262 313 360 54 159 426 7 455 24 142 291 377 77 109 470 354 345 203 307 232
 134 404 496 21 358 409 456 188 255 18 103 47 120 238 387 321 173 205 62 450 441 299 403 328 230 500 183
 269 473 1 48 284 351 114 199 143 26 334 388 417 250 301 158 42 33 395 499 424 12 92 279 365 65 97 144 380
 447 210 295 239 122 392 484 9 254 138 397 461 491 346 226 108 129 91 16 375 50 476 193 105 306 161 488
 218 39 391 316 76 36 234 493 53 102 442 322 204 225 187 131 471 146 68 289 201 383 257 80 314 135 487 412
 172 132 330 85 149 198 34 418 300 435 283 227 63 242 126 385 449 479 353 176 410 117 79 4 268 228 464
 181 93 294 130 10 396 27 379 323 64 338 222 481 41 71 430 272 2 213 175 100 459 324 56 277 189 390 245 106
 302 123 475 419 160 318 73 51 309 196 368 22 288 167 271 434 137 152 373 256 219 11 164 341 398 486 67
 420 285 147 233 367 384 216 118 263 414 169 292 405 502 352 381 163 494 326 437 78 248 469 88 315 260
 243 329 463 480 312 214 378 6 265 407 501 94 448 477 259 86 422 29 155 344 61 184 297 356 339 425 55 72
 408 310 474 140 361 503 207 190 40 221 355 182 14 125 251 402 157 280 393 452 340 369 151 168 0 406
 66 236 457 95 303 286 231 317 451 468 110 202 347 498 253 376 489 44 436 465 247 74 96 17 162 332 49 191
 399 382 327 413 43 60 206 298 443 90 349 472 81 178 343 113 495 440 28 145 258 287 192 170 428 57 139 394
 177 274 423 445 35 83 492 156 186 5 439 209 87 32 124 241 335 364 98 266 20 153 235 490 273 370 15 37 150
 179 84 252 282 101 31 305 69 128 220 337 431 460 194 362 116 249 331 82 483 466 111 133 246 275 180 348
 416 45 127 401 165 224 411 433 23 52 290 458 174 497 427 197 75 58 112 229 342 371 276 444 8 141 223 478
 261 320 3 25 119 148 386 240 270 89

Table B-4: N = 603

NOTE: The interleaver permutations for N = 603 are obtained by first computing the interleaver permutations for N = 600 and then inserting $\pi(21) = 602, \pi(121) = 601, \pi(221) = 600. \pi(21) = 602, \pi(121) = 601, \pi(221) = 600$.

127 490 316 213 386 406 14 306 63 445 137 203 499 152 88 585 540 178 4 78 435 602 271 509 575 599 524
 460 357 312 440 158 450 207 589 281 347 43 296 232 129 84 322 530 277 579 361 162 119 415 68 113 501
 456 94 302 594 351 133 425 0 187 550 376 273 228 466 74 366 123 505 197 263 559 212 148 45 218 238 446
 138 495 331 569 35 59 584 520 417 372 10 436 510 267 49 341 407 103 356 292 189 144 272 590 282 39 421
 222 179 475 128 64 561 516 154 362 109 411 193 485 60 601 247 500 545 333 288 526 134 426 183 565 257
 323 19 382 208 105 278 298 506 198 555 337 29 95 391 44 580 477 432 70 496 570 327 163 401 467 491 416
 352 249 204 332 50 342 99 481 173 239 124 21 188 11 214 535 253 471 576 422 169 54 5 393 560 492 586 307

25	243	348	194	486	317	268	165	442	155	358	79	397	15	120	566	258	89	40	537	104	527	130	451	223	387	110	
338	30	461	412	309	476	600	299	502	551	541	159	264	328	402	233	184	81	248	71	164	595	313	531	36	482	174	
114	556	453	20	552	46	367	85	303	408	254	1	377	437	225	392	215	418	139	457	75	180	26	318	149	100	597	274
587	190	511	229	447	170	398	90	521	472	369	536	359	562	283	55	219	324	388	462	293	244	141	308	131	224		
383	373	591	96	542	234	65	16	513	80	503	106	427	145	363	468	314	61	546	452	209	86	135	378	517	240	497	285
478	384	199	334	581	458	507	150	289	12	160	57	250	47	571	596	353	230	279	522	115	2	532	429	22	419	343	
368	125	220	51	294	433	156	304	201	394	191	443	140	6	374	423	66	205	528	76	573	56	563	487	512	269	146	
195	493	577	300	448	345	538	444	259	284	41	518	567	210	349	72	329	117	310	216	31	166	413	290	339	582		
121	62	592	489	82	479	403	428	185	280	111	354	547	434	364	261	454	251	175	200	557	52	483	126	265	588		
136	33	116	23	275	572	438	206	255	553	37	360	508	405	488	395	319	344	101	578	27	325	409	132	389	177	370	
276	91	350	181	539	463	226	549	504	142	42	399	161	473	122	7	311	235	598	321	494	514	414	171	424	245		
112	335	48	379	17	260	286	186	196	543	93	83	266	107	420	97	498	32	548	558	568	315	465	455	38	151	192	469
270	404	430	385	340	87	237	227	410	523	564	241	533	176	202	102	221	459	9	108	182	295	336	13	305	58	574	
474	484	231	381	371	554	67	326	439	77	320	346	246	256	3	153	143	544	167	480	157	449	92	118	18	28	375	525
515	98	211	252	529	330	464	380	390	400	147	297	287	470	583	24	301	593	236	262	217	172	519	69	168	242		
355	396	73	365	8	34	534	53	291	441	431																	

Table B-5: N = 804

168	361	473	794	38	53	487	346	764	87	135	102	635	265	57	216	424	520	391	491	666	153	442	6	780	169	281	
602	328	665	295	395	572	699	747	716	443	73	669	24	554	569	199	58	476	765	250	618	588	781	89	410	136	232	
103	203	378	507	154	524	251	685	477	314	362	377	7	670	284	573	459	426	396	589	381	540	748	40	715	11		
186	315	766	332	300	493	605	122	170	185	619	719	92	219	267	234	767	397	189	348	556	652	523	382	800			
285	574	138	108	301	413	734	460	797	427	527	702	27	478	44	575	205	801	638	686	701	331	190	608	93	783		
750	720	109	705	60	268	364	235	335	510	639	286	656	624	13	125	446	494	509	139	239	416	543	591	558	287		
721	513	672	76	172	43	706	320	609	94	462	432	625	737	254	784	317	751	47	222	351	802	368	95	529	321	158	
206	221	655	514	128	417	303	270	240	433	225	384	592	688	559	659	30	159	610	176	144	337	449	770	14	29		
463	563	740	63	111	78	611	241	33	192	400	496	367	226	644	129	418	786	756	145	257	578	304	641	271	371		
546	675	322	692	645	482	49	594	545	419	741	452	530	175	34	627	549	708	757	500	208	564	483	354	112	79		
179	130	773	290	661	402	353	468	387	260	338	787	83	435	357	516	565	306	16	131	453	164	724	691	550	742		
581	98	469	212	161	276	195	66	628	595	695	646	165	2	373	114	65	743	261	776	50	499	358	147	69	228	277	20
532	84	3	678	436	403	503	454	293	614	181	726	677	792	711	584	662	307	407	759	681	36	85	630	340	455	777	
488	244	211	70	262	101	422	793	536	485	600	519	390	148	115	215	166	489	326	697	438	389	263	585	296			
374	19	682	471	393	552	601	344	52	408	327	198	760	727	23	778	617	134	505	246	197	312	231	104	182	631		
731	279	201	360	409	150	664	779	297	8	568	535	394	586	425	746	313	56	5	120	39	714	472	439	539	490	9	
650	217	762	713	587	105	620	698	343	202	795	717	72	121	668	376	732	651	522	280	247	347	298	137	458			
25	570	521	636	555	428	506	151	10	603	733	106	55	330	155	621	88	525	684	184	474	299	637	411	763	236	59	
363	796	749	266	329	380	444	718	282	667	140	333	107	233	492	541	526	218	429	622	188	571	42	237	252			
700	74	445	671	604	171	123	90	475	752	461	156	41	782	349	334	26	75	430	798	379	654	45	623	508	204	253	479
412	141	735	704	283	560	269	768	653	590	157	383	316	687	238	606	187	464	657	431	557	12	61	46	542	753		
142	512	91	366	561	576	220	398	769	191	124	495	447	414	799	272	785	480	365	302	673	658	350	399	754			

318	703	174	369	143	28	528	577	803	736	465	255	224	607	80	593	288	173	110	481	707	640	207	562	126	511		
788	177	755	77	336	385	370	62	273	466	32	415	690	81	96	544	722	289	515	448	15	771	738	319	596	305	0	689
626	193	178	674	723	274	642	223	498	693	467	352	48	97	323	256	789	127	612	160	531	579	1	497	227	113		
404	434	548	31	275	386	597	82	709	401	694	501	308	660	450	739	420	772	339	790	613	64	35	405	210	242	356	
643	324	194	243	291	517	209	502	629	116	146	258	547	791	580	309	598	421	676	647	213	18	372	162	451			
132	484	51	99	325	17	551	437	728	758	68	355	599	710	117	406	229	725	214	21	632	180	774	259	744	292	663	
310	133	388	359	729	534	566	680	163	648	518	567	615	37	533	22	149	440	470	582	67	311	100	633	118	745		
196	167	537	342	696	486	775	456	4	375	423	649	341	71	761	248	278	392	679	119	230	441	730	553	245	538		
345	152	504	294	583	264	616	183	634	457	712	683	249	54	86	200												

Table B-6: N = 912

576	882	475	762	257	905	705	400	128	86	651	685	252	558	151	438	845	581	381	76	550	592	327	361	94	234	
739	114	521	671	57	664	226	268	3	37	682	822	415	702	197	347	645	422	814	856	591	625	358	498	464	751	
785	23	321	98	490	532	267	840	34	215	140	427	709	611	909	686	166	208	855	516	622	803	728	103	385	287	
585	362	8	878	531	192	132	479	404	691	61	461	261	38	596	554	207	780	720	155	80	367	649	137	849	544	272
230	795	456	396	743	295	43	325	725	525	220	860	818	471	505	72	378	883	258	1	401	201	808	536	494	147	
181	660	54	559	846	341	77	789	484	46	88	735	769	502	642	235	522	17	665	465	160	634	676	411	445	178	318
823	198	605	755	141	748	310	352	87	121	766	906	499	786	281	431	729	506	898	28	675	336	442	582	548	835	
869	107	405	182	574	616	351	12	118	299	224	511	793	695	81	770	250	292	27	600	706	887	812	187	469	371	
669	446	92	50	615	276	216	563	488	775	145	545	345	122	680	638	291	864	804	239	164	451	733	221	21	628	
356	314	879	540	379	127	827	589	809	480	902	32	409	609	304	555	55	342	462	265	485	156	578	620	85	285	
892	231	643	18	138	853	161	744	172	130	425	873	568	819	319	606	726	529	749	586	760	718	101	549	244		
495	907	282	402	205	839	262	436	394	689	225	832	171	583	870	78	420	515	850	112	70	365	813	590	759	632	
7	666	96	191	526	700	658	41	489	266	435	308	595	383	684	779	202	376	334	877	165	854	111	896	271	59	360
455	790	134	176	553	753	530	699	572	859	647	36	629	300	722	764	229	429	206	375	248	535	323	624	305		
888	398	440	817	105	712	51	463	211	911	673	893	564	74	116	493	693	388	639	139	426	546	349	569	240	662	
704	169	369	64	315	727	102	222	25	245	828	256	214	509	45	652	903	403	690	810	613	833	670	844	802	185	
633	328	579	79	366	486	289	11	346	520	478	773	309	4	255	667	42	162	504	599	22	196	154	449	897	674	843
716	91	750	180	275	610	784	742	125	573	350	519	679	467	195	49	26	460	286	418	863	249	392	768	783	444	
837	260	68	874	539	355	143	614	637	218	459	120	513	848	656	384	713	31	731	290	313	806	135	708	189	524	
332	60	389	619	407	796	901	482	723	757	777	200	547	648	65	834	83	472	577	158	399	433	453	788	223	324	
653	510	630	148	5	746	75	109	129	298	811	0	329	186	306	736	593	340	663	697	717	886	487	754	419	774	
894	412	269	16	339	373	393	562	163	430	95	450	570	170	857	604	15	588	69	238	212	106	683	126	246	758	533
280	603	264	657	826	800	694	359	175	875	434	209	868	279	852	333	668	476	370	35	763	551	110	133	626		
867	528	9	344	152	792	623	439	227	698	721	302	543	204	597	20	740	468	797	115	815	374	397	890	219	253	
273	608	416	144	473	703	491	880	73	566	807	841	861	284	631	732	149	6	167	556	661	242	483	517	537	872	
307	408	737	594	714	232	89	830	159	193	213	382	895	84	413	270	390	820	677	424	747	781	801	58	571	838	
503	858	66	496	353	100	423	457	477	646	247	514	179	534	654	254	29	688	153	190	617	364	99	330	767	842	
296	322	210	672	741	778	293	40	687	47	443	518	884	910	259	348	417	454	217	710	363	635	119	194	560	752	
847	24	93	876	805	386	39	311	707	782	236	428	523	612	681	552	481	62	627	899	881	458	824	104	199	288	357

228 157 650 303 575 557 52 500 692 787 337 33 816 745 326 891 251 233 640 715 368 90 13 621 492 173 2
567 798 821 316 391 44 678 601 297 168 761 508 243 474 497 904 67 466 354 277 885 10 437 184 831 150
587 580 655 142 30 865 561 598 113 772 507 738 263 338 331 730 618 541 237 274 701 448 183 414 851
14 380 406 294 756 825 862 377 124 771 131 527 602 56 82 343 432 501 538 301 794 447 719 203 278 644
836 19 108 177 48 889 470 123 395 791 866 320 512 607 696 765 636 565 146 711 71 53 542 908 188 283 372
441 312 241 734 387 659 641 136 584 776 871 421 117 900 829 410 63 335 317 724 799 452 174 97

Table B-7: N = 1200

199 1000 670 477 613 236 684 372 809 98 951 179 547 148 1018 825 961 584 1194 720 1157 446 229 527 895
496 1139 1173 109 932 342 1068 305 794 447 875 43 844 514 321 327 80 690 216 653 1142 795 23 1137 1192 862
669 805 428 1038 564 1001 290 1143 371 739 340 10 1017 1153 776 186 328 149 638 291 719 1087 688 131 1138
301 1124 534 60 497 986 639 1067 235 1036 706 513 649 272 882 408 391 134 987 215 583 184 1054 861 997
620 30 756 1193 482 135 563 931 532 202 9 145 968 378 520 341 830 483 846 79 880 550 357 493 116 726
252 689 1178 831 59 427 28 898 705 841 464 912 600 1037 326 1179 407 775 376 46 1053 1189 812 222 948 185
674 457 755 1123 724 394 201 337 1160 570 96 533 1022 675 1103 271 845 742 549 555 308 918 444 881 170
1023 251 165 220 1090 897 1033 656 1104 792 29 518 171 599 967 568 238 45 181 1004 414 1140 377 866 519 947
115 916 359 166 529 152 762 288 725 14 867 95 463 64 934 741 747 500 1110 636 619 362 15 443 811 412 82
1089 25 848 258 984 221 710 363 791 1159 760 430 237 373 1196 606 748 569 1058 711 1074 307 1108 778 358
721 344 954 480 917 206 1059 287 655 256 1126 933 1069 692 102 828 65 554 207 635 1003 604 274 81 217
1040 450 1176 413 902 685 983 151 952 622 429 565 188 798 324 761 50 903 66 499 1073 970 777 913 536
1146 672 1109 398 51 479 393 448 118 1125 61 884 132 1020 257 746 399 827 1195 796 466 273 409 32 642 168
605 1094 877 1175 343 1144 587 621 757 380 990 516 953 242 1095 323 691 292 1162 969 975 728 138 864 847
590 243 671 310 117 640 1019 1076 585 938 449 253 486 12 591 658 465 988 167 224 187 86 797 601 834 976
939 1006 586 136 515 572 535 434 1145 949 1182 708 87 154 1161 484 863 920 883 782 1039 97 330 1056 435 502
309 832 11 68 31 1130 641 445 678 204 783 850 657 1180 294 416 379 278 989 793 1026 552 1131 1198 1005 101
707 764 727 626 137 1141 174 900 279 346 153 676 1055 1112 1075 974 485 289 360 48 627 694 501 1024 203
260 223 122 833 637 870 396 1105 815 849 172 551 608 571 470 1181 985 18 744 123 190 1197 293 899 956
919 818 329 3 366 1092 471 538 345 868 47 104 813 1166 677 481 714 240 819 886 693 16 395 452 415 314
1025 829 1062 4 1167 1007 814 364 743 800 763 662 173 1177 210 936 315 382 189 712 1091 1148 1111 1010 67 325
558 84 663 730 537 1060 239 296 259 158 869 673 906 432 1011 1078 885 208 522 644 607 506 17 1021 54 196
159 226 33 556 935 992 955 854 365 169 402 1128 507 574 381 904 83 140 103 2 713 517 588 276 855 922
729 52 431 488 451 350 1061 865 1098 624 133 70 1077 400 779 836 799 698 209 13 246 972 351 418 225 521
1127 1184 1147 1046 557 231 594 120 699 766 573 1096 275 332 1041 194 905 709 780 468 1047 1114 921 244 623
680 643 542 53 1057 90 816 195 35 1042 592 971 1028 991 890 401 205 438 1164 543 610 417 940 119 176 139
38 295 423 786 312 891 958 765 88 467 524 487 386 1097 901 1134 660 39 106 1113 436 750 872 835 734 245
49 282 424 387 784 735 630 593 156 1082 397 454 34 20 1163 1183 1132 1083 978 941 504 230 745 802 609 368
311 331 280 361 126 89 852 578 1093 1150 957 716 659 679 628 579 474 437 0 926 241 298 105 1064 942
1027 749 927 822 785 348 74 589 646 453 212 155 175 124 75 1008 1133 696 422 937 994 801 560 503 69 472
553 318 281 1044 770 85 142 1149 908 851 871 820 771 666 629 192 1118 433 263 297 56 1199 19 1168 1119 1014
523 540 266 651 838 645 404 347 367 316 267 162 125 888 614 1129 1186 993 752 695 261 664 615 510 473

652 962 277 334 141 1100 1043 1063 1012 963 858 821 384 110 625 682 262 248 191 211 160 111 6 715 732
458 973 1030 837 596 539 559 508 459 354 317 1080 806 121 178 1185 944 887 907 856 807 702 665 228
1154 469 526 333 92 1170 55 977 1155 1050 1013 576 302 817 874 681 440 383 403 352 303 36 161 924 650 1165
22 1029 788 731 751 700 781 546 509 72 998 313 370 177 1136 1079 1099 1048 999 894 857 420 146 661 718 525
284 227 247 1169 147 42 5 768 494 879 1066 873 632 575 595 544 495 390 353 1116 842 157 214 21 980 923
489 892 843 738 701 264 1190 505 562 369 128 71 91 40 1191 1086 1049 612 338 853 683 490 476 419 439 388
339 234 943 960 686 1 58 1065 824 767 787 736 687 582 545 108 1034 349 406 213 1172 1115 1135 1084 1035 930
893 1072 182 697 754 561 320 198 283 232 183 78 41 804 530 1045 1102 909 668 611 631 580 531 426 389
1152 878 193 250 57 1016 959 979 928 1009 774 737 300 26 541 598 405 164 107 127 76 27 1122 1085 648 374 889
946 753 512 455 475 197 375 270 233 996 722 37 94 1101 860 803 823 772 723 456 581 144 1070 385 442 249
8 1151 717 966 319 733 218 1071 1120 356 492 790 929 597 299 114 667 1081 566 219 268 704 840 911 77 945
647 462 1015 99 914 567 616 1052 1188 286 1171 93 995 810 163 577 62 915 964 200 336 634 773 441 143 1158
511 925 410 63 112 548 100 982 1121 789 491 306 859 73 758 411 460 896 1032 130 269 910 839 654 7 421
1106 759 808 44 180 478 617 285 1187 1002 355 769 254 1107 1156 392 528 826 965 633 335 150 703 1117 602
255 304 740 876 1174 113 981 618 498 1051 265 950 603 425 1088 24 322 461 129 1031

Table B-8: N = 1284

242 317 1155 16 684 823 879 960 163 261 659 854 229 53 669 534 420 810 644 696 1183 1281 395 88 998 1073
627 772 214 546 351 490 668 457 131 326 985 809 363 508 1176 31 116 168 655 753 1151 844 721 545 1161
1026 912 18 1136 1188 391 489 887 580 206 281 1119 1264 706 1038 843 982 1160 949 623 818 193 17 855 1000 384
523 608 660 1147 1245 359 52 1213 1037 369 234 178 510 344 454 883 981 95 1072 698 773 327 472 1198 246 51
190 368 157 1115 26 685 509 63 208 876 1015 1100 1152 355 453 851 544 421 245 861 726 670 1002 836 946
1124 189 587 782 1190 1265 819 964 406 487 543 682 860 649 323 518 1177 1001 555 700 84 223 308 360 847
945 59 1036 913 737 69 1218 1162 210 44 154 332 681 1079 1274 398 473 27 172 840 979 1035 1174 68 1141 815 1010
385 209 825 1192 576 715 800 852 55 153 551 244 121 1229 561 426 370 702 536 646 824 1173 287 482 890
965 519 664 48 187 243 382 811 349 23 218 877 701 33 1182 1068 174 8 60 547 645 1043 736 613 437 1053 918
862 1194 1028 1138 32 381 779 974 98 173 1011 1156 540 679 735 874 19 841 515 710 85 1193 525 390 276 666 500
552 1039 1137 251 1228 1105 929 483 126 70 402 207 346 524 313 1271 182 590 665 219 364 1032 1171 1227 82 511
49 1007 1202 577 401 1017 882 768 1158 992 1044 247 345 743 436 62 137 975 1120 562 894 699 838 1016 805 479
674 1082 1157 711 856 240 379 435 516 1003 541 215 410 1069 893 225 90 1260 366 200 252 739 837 1235 928
554 629 183 328 1054 102 1191 46 224 13 971 1166 290 365 1203 64 732 871 956 1008 211 309 707 400 717 582
101 136 858 277 45 1231 468 692 744 443 675 820 1121 374 594 1046 505 716 262 399 538 179 411 556 857
892 79 1033 801 703 1224 164 216 1199 1209 1074 593 628 66 769 537 439 1018 1184 10 935 1167 28 329 866 1086 254
997 1208 754 891 1030 671 903 1048 65 100 571 241 9 1195 432 656 708 407 417 282 1085 338 558 1261 1029 680
226 392 502 143 375 520 821 74 43 746 205 416 1246 99 238 1163 111 256 557 592 1063 733 501 403 924 1148
1200 899 909 774 293 830 1050 469 237 1172 718 884 994 635 867 1012 29 566 535 1238 697 908 396 591 730
371 603 748 1049 1084 271 1225 993 895 132 356 408 107 117 1266 785 38 258 961 729 380 1210 92 202 1127 75
220 521 1058 1027 446 1189 367 888 1083 1222 863 873 738 257 292 1014 433 201 103 624 848 900 599 609 474
1277 530 750 169 1221 872 418 584 694 335 567 712 1013 266 235 938 397 859 96 291 430 71 81 1230 749 784
222 925 693 595 1116 56 108 1091 1101 966 485 1022 1242 661 1153 80 910 1047 1186 827 1059 1204 221 758 727 146

889	67	588	783	922	563	573	438	1241	1276	714	133	1185	1087	324	548	600	299	531	676	977	230	450	902	361		
572	118	255	394	35	267	412	713	1250	1219	638	97	559	1080	1275	130	1055	1065	930	449	484	1206	625	393	295	816	
1040	1092	791	1023	1168	185	722	942	110	853	1064	610	747	886	527	759	904	1205	1240	427	1130	1149	1051	288	512		
564	263	273	138	941	976	414	1117	885	787	24	248	300	1283	231	376	677	1214	150	602	61	272	1102	1239	94	1019	
413	755	1004	259	1056	357	780	1251	112	919	448	589	149	491	740	1279	792	93	574	765	630	906	184	325	1169		
227	447	764	586	553	310	723	868	642	422	1094	905	1247	212	751	264	849	1272	459	604	127	940	1081	983			
1178	1232	236	1257	817	114	1122	641	58	1066	585	719	914	939	1256	1215	302	1134	76	377	1078	802	1045	455	148	704	
1243	951	289	619	1096	113	756	480	57	191	386	440	728	465	25	606	330	1133	550	274	1077	1211	122	147	464	423	
794	91	568	869	286	1236	253	947	640	1196	451	159	781	1111	304	605	1248	972	549	683	878	932	1220	957	517		
1098	822	341	1042	766	285	419	614	639	1207	915	2	583	1060	77	778	444	745	155	1132	404	943	429	1273	319	294	
1097	456	180	1041	1175	86	140	428	165	1009	306	30	833	250	1258	777	911	1106	1131	415	123	494	1075	268	569		
1270	936	1237	647	340	896	151	921	481	1062	786	305	948	672	249	383	578	632	920	657	217	798	522	41	742		
466	709	119	314	339	907	615	986	283	760	1061	478	144	445	1139	832	104	643	129	973	270	1278	797	156			
1164	741	875	1070	1095	128	87	458	6	232	533	1234	958	1201	611	806	831	115	1107	194	775	1252	269	970	636	937	
347	40	596	1135	621	181	762	486	5	648	372	1233	83	278	303	620	579	950	498	724	1025	442	166	409	1103	796	
39	607	315	686	1267	460	761	120	1128	705	839	532	1088	343	1113	673	1254	978	497	1140	864	441	575	770	795		
1112	1071	158	990	1216	233	934	658	901	560	145	336	1197	311	1253	475	612	807	1099	952	4	296	1165	72	933	47	
989	462	348	321	835	186	1024	3	650	1150	109	1067	725	198	142	279	320	424	1262	1052	637	828	405	803	461		
967	1104	15	307	160	496	788	373	622	141	539	197	954	898	813	1076	678	734	495	1142	358	601	275	1217	690		
634	771	812	916	470	260	1129	36	897	11	953	175	312	507	799	652	988	1280	865	1114	633	1031	689	162	106	21	
284	1170	1226	987	350	850	1093	767	425	931	1126	1263	20	124	962	752	337	528	105	503	161	667	804	999	7		
1144	196	488	73	322	1125	239	1181	654	598	513	776	378	434	195	842	0	301	1259	917	139	334	471	763	616	170	
1244	829	1020	597	995	653	1159	12	1269	499	352	688	980	565	814	333	731	389	1146	1090	1005	1268	870	926	687		
50	492	793	467	125	631	826	963	1255	1108	662	452	37	228	1089	203	1145	618	504	477	991	342	1180	188	1057	22	
265	1223	881	354	298	213	476	78	134	1179	542	984	1	959	617	1123	34	171	463	316	1154	944	529	720	297	695	
353	1110	996	969	199	834	388	651	14	514	757	431	89	846	790	927	968	570	626	387	1034	192	493	167	1109	331	
526	663	955	808	362	152	1021	1212	789	1187	845	318	204	177	691	42	880	1143	506	1006	1249	923	581	54	1282	135	
176	280	1118																								

Table B-9: N = 1539

NOTE: The interleaver permutations for N = 1539 are obtained by first computing the interleaver permutations for N = 1536 and then inserting $\pi(21) = 1538, \pi(121) = 1537, \pi(221) = 1536. \pi(21) = 1538, \pi(121) = 1537, \pi(221) = 1536.$

1014	1137	191	1246	656	905	960	1423	817	723	1532	300	162	178	195	394	1340	53	108	571	1501	1538	1300	894	518	
1060	862	879	1078	488	95	792	1255	649	448	42	1202	208	10	27	226	1065	779	1010	403	1333	1132	726	350	892	801
1391	1445	213	1463	158	1087	481	387	1196	1500	1362	1485	539	593	897	1253	842	235	1165	1071	344	648	510	633		
1223	1277	152	401	456	919	313	219	1028	1332	1194	1210	1227	1426	836	1085	1140	67	997	796	390	14	556	358	375	574
1520	1127	288	751	145	1480	1074	698	1240	1042	1059	1258	561	275	506	1435	829	628	222	1382	1537	388	297	207	941	
1245	959	1190	583	1513	1419	692	996	858	981	35	89	393	749	338	1267	661	567	1376	144	6	129	719	773	1184	1433
1488	415	1345	1251	524	828	690	706	1403	922	332	581	636	1099	493	292	1208	1046	52	1390	1407	70	1016	623	1320	247

1177 976 570 194 736 538 555 754 57 1307 2 931 325 124 1254 878 1420 1329 1239 437 741 455 686 79 1009 915
 402 492 354 477 1067 1121 1425 245 1370 763 157 63 872 1176 1038 1161 215 1536 269 680 929 984 1447 841 747
 20 324 186 202 899 418 1364 77 132 595 1525 1324 704 542 1084 886 903 1102 512 761 816 1279 673 472 66 1226
 232 34 51 250 1089 803 1034 427 1357 1156 750 374 916 825 735 1469 237 1487 182 1111 505 411 1434 1524 1386
 1509 563 617 921 635 866 259 1189 1095 368 672 534 657 1247 1301 176 425 480 943 337 243 1052 1356 1218
 1234 395 1450 860 1109 1164 91 1021 820 200 38 580 382 399 598 8 257 312 775 169 1504 1098 722 1264 1066 1083
 1282 585 299 530 1459 853 652 246 1406 412 321 231 965 1269 983 1214 607 1 1443 930 1020 882 1005 59 113 417
 131 362 1291 685 591 1400 168 30 153 743 797 1101 1457 1512 439 1369 1275 548 852 714 730 1427 946 356 605
 660 1123 517 316 1232 1070 76 1414 1431 94 1040 1289 1344 271 1201 1000 594 218 760 562 579 778 188 1331 26 955
 349 148 1278 902 1263 461 1353 516 479 1444 939 1033 765 710 103 426 1091 1145 501 1200 1163 378 87 181 1449
 1394 787 896 239 293 1185 348 953 1062 771 865 597 1008 1471 44 923 442 333 566 101 210 1348 13 1388 156 619
 728 927 1126 910 1250 785 1108 496 697 536 840 1303 90 75 274 58 398 827 256 1180 1381 1220 1058 451 774 759
 1493 742 1082 1511 940 435 529 261 206 1135 1458 587 641 1533 696 659 1410 1119 1213 945 890 283 392 1271
 1325 681 1380 449 558 267 361 93 504 967 1076 419 1474 1365 528 1133 1242 844 1045 884 1188 115 224 423 622
 406 746 281 604 1528 193 32 336 799 1122 1107 1306 1090 1430 323 1288 676 877 716 554 1483 270 255 989 238
 578 1007 436 1467 25 1293 1238 631 954 83 137 1029 192 155 906 615 709 441 386 1315 1424 767 821 177 876
 1481 54 1299 1393 1125 0 463 572 1451 970 861 24 629 738 340 541 380 684 1147 1256 1455 118 1438 242 1313 1422
 1024 1225 1064 1368 295 618 603 802 586 926 1355 784 172 373 212 50 979 1302 1287 485 1270 74 503 1468 963
 1057 789 734 127 450 1115 1169 525 1224 1187 616 111 205 1473 1418 811 920 263 317 1209 372 977 1086 795 889
 621 1032 1495 68 947 466 357 1056 125 234 1372 37 1412 180 643 752 951 1150 934 1274 809 918 520 721 560 864
 1327 114 99 298 82 422 851 280 1204 1405 1244 12 475 798 783 1517 766 1106 1535 964 459 553 285 230 1159 1482
 611 665 21 720 683 112 1143 1237 969 914 307 416 1295 1349 705 1404 473 582 291 385 117 62 991 1100 443
 1498 1389 552 1157 1266 975 1069 908 1212 139 248 447 646 430 770 305 414 16 217 56 360 823 1146 1131 1330
 1114 1454 347 1312 700 901 740 1044 1507 294 1013 262 978 1317 655 1384 460 49 1031 1262 279 602 161 1053 1448
 465 1339 639 1144 733 179 410 107 216 596 900 1094 1417 791 78 1505 845 201 487 1149 1323 1280 48 708 565
 1475 762 653 1529 885 1171 404 471 642 266 1392 1249 1479 1446 1337 142 1462 319 1088 1048 1326 950 540 397 627
 808 1379 826 610 1003 236 196 474 98 758 1081 1311 1492 527 1510 1294 151 813 880 944 1248 1442 229 1139 640
 1211 1193 549 835 1497 135 92 396 590 913 287 1110 1001 341 1233 1519 645 819 776 1080 204 61 971 258 149
 1025 381 667 1436 1503 138 1298 888 745 119 942 833 1174 958 1351 584 544 822 446 36 1429 123 304 875 322
 106 499 1268 1228 1506 1130 254 577 807 988 23 1006 790 1183 309 376 654 744 938 1261 1491 136 707 689 45 331
 993 1167 1124 1428 86 409 1319 606 497 1373 729 1015 141 315 272 576 1236 1093 467 1290 1181 521 1413 163 932
 999 956 794 384 241 1151 438 329 670 454 847 80 40 318 1478 1068 925 1155 1336 371 1354 1138 1531 764 724
 1002 626 1286 73 303 484 1055 502 286 679 1341 1408 150 240 434 757 987 1168 203 185 1077 1363 489 663 620
 924 1118 1441 815 102 887 869 225 511 1173 1347 1304 72 732 589 1499 786 677 17 909 1195 428 495 452 290
 1416 1273 647 1470 1361 166 1486 343 1112 1072 1350 974 564 421 651 832 509 850 634 1027 260 220 498 122 782
 1105 1335 1516 551 1534 1318 175 837 904 1182 1272 1466 253 483 664 1235 1217 573 859 1521 159 116 420 614 937
 311 1134 383 365 1257 7 669 843 800 1104 228 85 995 282 173 1049 405 691 1460 1527 1484 1322 912 769 143 966
 857 1198 982 1375 608 568 846 470 60 1453 147 328 5 346 130 523 1292 1252 1530 1154 278 601 831 1012 47 1030
 814 1207 440 400 678 768 962 1285 1515 160 731 713 69 355 1017 1191 1148 1452 110 433 1343 630 1415 1397 753
 1039 165 339 296 600 1260 1117 491 1314 1205 545 1437 187 849 1023 408 462 104 64 980 478 353 871 1175 265
 694 818 1092 1360 788 748 342 1162 1037 19 1179 949 1378 1502 1310 508 1472 1432 1026 310 1079 703 327 97 526 650
 458 1192 513 687 174 994 227 1387 1011 781 209 264 1142 126 1197 1371 644 249 911 535 839 1465 893 948 756
 810 345 519 1328 933 701 1219 1523 613 41 96 1440 1494 1136 1096 476 81 1385 367 671 1297 190 780 588 856 284

244	1374	658	533	1051	675	445	874	998	806	4	968	928	522	1342	575	199	1359	1129	22	146	1490	688	9	183	1206
490	1259	883	507	277	1241	830	638	1158	693	867	140	1281	407	31	335	961	389	444	252	306	1377	15	824	429	197
715	1019	109	1073	1128	936	990	632	592	1508	1113	881	1399	167	793	1222	276	84	352	1316	1276	870	154	29	547	171
1477	370	494	302	1036	464	424	18	838	71	1231	855	625	1054	1178	986	184	1041	1215	702	1522	755	379	3	1309	737
326	134	868	189	363	1172	777	1439	1063	1367	457	1421	1476	1284	1338	873	1047	320	1461	1229	211	515	1141	569	624	
432	486	128	88	1004	609	377	895	1199	289	718	1308	1116	1170	812	772	366	1186	1061	43	1203	973	1402	1526	1334	532
1496	1456	1050	334	1103	727	351	121	550	674	482	1216	537	711	198	1018	251	1411	1035	805	233	1358	1166	364		
1221	1395	668	273	935	559	863	1489	917	972	314	834	369	543	1352	957	725	1243	11	637	65	120	1464	1518	1160	
1120	500	105	1409	391	695	1321	214	804	612	666	308	268	1398	682	557	1075	699	469	898	1022	1296	28	992	952	
546	1366	599	223	1383	1153	46	170	1514	712	33	100	1230	514	1283	907	531	301	1265	854	662	1396	717	891	164	
1305	431	55	359	985	413	468	1346	330	1401	39	848	453	221	739	1043	133	1097	1152							

Table B-10: N = 1759

NOTE: The interleaver permutations for N = 1759 are obtained by first computing the interleaver permutations for N = 1752 and then inserting $\pi(21) = 1758, \pi(121) = 1752, \pi(221) = 1756, \pi(321) = 1755, \pi(421) = 1754, \pi(521) = 1753, \pi(621) = 1757$

$$\pi(21) = 1758, \pi(121) = 1752, \pi(221) = 1756, \pi(321) = 1755, \pi(421) = 1754, \pi(521) = 1753, \pi(621) = 1757.$$

196	1350	469	101	1395	519	1017	947	1580	1738	624	1032	496	1650	769	401	1695	859	1317	1247	128	1758	286	924	446	
796	198	1069	701	243	1159	1617	1547	428	586	1224	746	1096	498	1369	1001	543	1459	165	95	728	886	1524	1046	1396	
798	1669	1301	843	7	465	395	1028	1186	72	1346	1696	1098	217	1601	1143	307	765	695	1328	1486	372	1646	244	1398	517
149	1443	607	1065	995	1628	34	672	194	544	1698	817	449	1743	907	932	1295	176	334	106	494	844	246	1117	749	
291	1207	1665	1595	476	634	1272	794	1144	546	1417	1049	591	1507	213	143	776	934	1572	1094	1752	1444	846	1717		
1349	891	55	513	443	1076	1234	120	1394	1744	1146	265	1649	1191	355	813	743	1376	1534	420	1694	292	1446	565	197	
1491	655	1113	1043	1676	82	720	242	592	1746	865	497	39	955	1413	1343	224	382	1020	542	66	294	1165	797	339	1255
1713	1643	524	682	1320	842	1192	594	619	1097	639	1555	261	191	824	982	1620	1142	1492	894	13	1397	939	103	561	
491	1124	1282	168	1442	40	1194	313	1697	1239	403	861	791	1424	1582	468	1742	340	1494	613	1756	245	1539	703	1161	
1091	1724	130	768	290	640	42	913	545	87	1003	1461	1391	272	430	1068	590	940	342	1213	845	387	1303	9	1691	572
730	1368	890	1240	642	1513	1145	687	1603	309	239	872	1030	1668	1190	1540	942	61	1445	987	151	609	539	1172	1330	
216	1490	88	1242	361	1745	1287	451	909	839	1472	1630	516	38	388	1542	661	293	1587	751	1209	1139	20	178	816	338
688	90	961	593	135	1051	1509	1439	320	478	1116	638	988	390	1261	893	435	1351	1755	57	1739	620	778	1416	938	
1288	690	1561	1193	735	1651	357	287	920	1078	1716	1238	1588	990	109	1493	1035	199	657	587	1220	1378	264	1538	136	
1290	409	41	1335	459	957	887	1520	1678	564	972	436	1590	709	341	1635	799	1257	1187	68	226	864	386	736	138	
1009	641	183	1099	1557	1487	368	526	1164	686	1036	438	1309	941	483	1399	105	35	668	826	1464	986	1336	738	1609	
1241	783	1699	405	335	968	1126	12	1286	1636	1038	157	1541	1083	247	705	635	1268	1754	1426	312	1586	184	1338	457	
89	1383	547	1005	935	1568	1726	612	134	484	1638	757	389	1683	847	1305	1235	116	274	46	434	784	1012	1057	689	231
1147	1605	1535	416	574	1212	734	1084	486	1357	989	531	1447	153	83	716	874	1512	1034	1384	786	1657	1289	831	1747	
453	383	1016	1174	60	1334	1684	1086	205	1589	1131	295	753	683	1316	1474	360	1634	232	1386	505	137	1431	595	1053	
983	1616	22	660	182	532	1686	805	437	1731	895	1353	1283	164	322	960	482	1753	832	234	1105	737	279	1195	1653	
1583	464	622	1260	782	1132	534	559	1037	146	1495	201	131	764	922	1560	1082	1432	834	1705	1337	879	43	501	431	

1064 1222 108 1382 1732 1134 253 1637 1179 343 801 731 1364 1522 408 1682 280 1434 553 185 1479 643 1101 1031
 1664 70 708 230 580 1734 853 485 27 943 1401 1331 212 370 1008 530 880 282 1153 785 327 1243 1701 1631 512 670
 1308 830 1180 582 1453 1085 627 1543 249 179 812 970 1608 1130 1480 882 1 1757 1385 927 91 549 479 1112 1270 156
 1430 28 1182 301 1685 1227 391 849 779 1412 1570 456 1730 328 1482 601 233 1527 691 1149 1079 1712 118 756 278
 628 30 901 533 75 991 1449 1379 260 418 1056 578 928 330 1201 833 375 1291 1749 1679 560 718 1356 878 1228 630
 1501 1133 675 1591 297 227 860 1018 1656 1178 1528 930 49 1433 975 139 597 527 1160 1318 204 1478 76 1230 349
 1733 1275 439 897 827 1460 1618 504 912 376 1530 649 281 1575 739 1197 1127 8 1485 804 326 676 78 949 581 123
 1039 1497 1427 308 466 1104 626 976 378 1249 881 423 1339 45 1727 608 766 1404 926 1276 678 1549 1181 723 1639
 345 275 908 1066 1704 1226 1576 978 97 1481 1023 187 645 575 1208 1366 252 1526 124 1278 397 29 1323 487 945 875
 1508 1666 552 74 424 1578 697 329 1623 787 1245 1175 56 214 852 374 724 952 997 629 171 1087 1545 1475 356 514
 1152 674 1024 426 1297 929 471 1387 93 23 656 814 1452 974 1324 726 1597 1229 771 1687 393 323 956 1114 0 1274
 1624 1026 145 1529 1071 235 693 623 1256 1414 300 1574 172 1326 445 77 1371 535 993 923 1556 1714 600 122 472
 1626 745 377 1671 835 1293 1223 104 262 900 422 772 174 1045 677 219 1135 1593 1523 404 562 1200 722 1072 474
 499 977 86 1435 141 71 704 862 1500 1022 1372 774 1645 1277 819 1735 441 371 1004 1162 48 1322 1672 1074 193 1577
 1119 283 741 671 1304 1462 348 1622 220 1374 493 125 1419 583 1041 971 1604 10 648 170 520 1674 793 425 1719
 883 1341 1271 152 310 948 470 820 222 1093 725 267 1183 1641 1571 452 610 1248 770 1120 522 1393 1025 567
 1483 189 119 752 910 1548 1070 1420 822 1693 1325 867 31 489 419 1465 1210 96 1370 1720 1122 241 1625 1167 331 789
 719 1352 1510 396 1670 268 1422 541 173 1467 631 1089 1019 1652 58 696 218 568 1722 841 473 15 931 1389 1319 200
 358 996 518 868 270 1141 773 315 1231 1689 1619 500 658 1296 818 1168 570 1441 1073 615 1531 237 167 800 958
 1596 1118 1468 870 1741 1373 915 79 537 467 1100 1258 144 1418 16 1170 289 1673 1215 379 837 767 1400 1558 444
 1718 316 1470 589 221 1515 679 1137 1067 1700 1425 744 266 616 18 889 521 63 979 1437 1367 248 406 1044 566 916
 318 1189 821 363 1279 1737 1667 548 706 1344 866 1216 618 1489 1121 663 1579 285 215 848 1006 1644 1166 1516 918
 37 1421 963 127 585 515 1148 1306 192 1466 64 1218 337 1721 1263 427 885 815 1448 1606 492 14 364 1518 637 269
 1563 727 1185 1115 1748 154 792 314 664 892 937 569 111 1027 1052 1415 296 454 1092 614 964 366 1237 869 411
 1327 33 1715 596 754 1392 914 1264 666 1537 1169 711 1627 333 263 896 1054 1692 1214 1564 966 85 1469 1011 175 633
 563 1196 1354 240 1514 112 1266 385 17 1311 475 933 863 1496 1654 540 62 685 317 1566 362 775 412 202 44 1611
 1233 1163 840 985 617 114 662 1075 712 502 344 159 1533 1463 1140 1285 917 414 962 1375 186 802 644 26 81 11
 1440 1585 1217 714 1262 1675 1312 1102 944 759 381 311 1740 133 1517 1014 1562 223 1612 1402 1244 1059 681 611 288
 433 65 1314 110 523 160 1702 1544 1359 981 911 588 733 365 1614 410 823 460 250 92 1659 1281 1211 888 1033 665
 162 710 1123 760 550 392 207 1581 1511 1188 1333 965 462 1010 1423 1060 850 692 507 129 59 1488 1633 1265 762
 1310 1723 1360 1150 1405 807 429 359 36 181 1565 1062 1610 271 1660 1450 1292 1107 729 659 336 481 113 1362 158
 571 208 1750 1592 1407 1029 959 636 781 413 1662 458 871 508 298 140 1707 1329 1259 936 1081 713 210 758
 1171 808 598 440 255 1629 1559 1236 1381 1013 510 1058 1471 1108 898 740 555 177 107 1536 1681 1313 810 1358 19
 1408 1198 1040 855 477 407 84 229 1613 1110 1658 319 1708 1498 1340 1155 777 707 384 529 161 1410 206 579 256
 1365 1640 1455 1077 1007 684 829 461 1710 506 919 556 346 188 3 1377 1307 984 1129 761 258 806 1219 856 646
 488 303 1677 1607 1284 558 1584 225 788 155 946 603 1429 1061 1519 1106 1156 858 132 525 1088 455 1246 903
 1729 1361 67 1406 1456 1158 432 825 1388 755 1546 1203 277 1661 367 1706 4 1458 732 1125 1688 1055 94 1503 577 209
 667 254 304 6 166 992 236 1355 394 51 877 509 967 554 604 306 1332 1725 536 1655 694 351 1177 809 1267 854
 904 606 1632 273 836 203 994 651 1477 1109 1567 1154 1204 906 180 573 1136 503 1294 951 25 1409 115 1454 1504
 1206 480 873 1436 803 1594 1251 325 1709 415 2 52 1506 780 1173 1736 1103 142 1551 625 257 715 302 352 54 1080
 1473 284 1403 442 99 925 557 1015 602 652 354 1380 21 584 1703 742 399 1225 857 1315 902 126 654 1680 321 884
 251 1042 699 1525 1157 1615 1202 1252 954 228 621 1184 551 1342 999 73 1457 163 1502 1552 1254 528 921 1484 851
 1642 1299 373 5 463 50 100 1554 828 1221 32 1151 190 1599 673 305 763 350 400 1521 490 650 700 102 605 147

1063 1451 332 973 1128 69 790 950 1000 402 905 447 1363 1751 632 1273 1428 369 1090 1250 1300 702 1205 747 1663
 299 1345 1573 1728 669 1390 1550 1600 1002 1505 1047 211 599 1232 121 276 969 1690 98 148 1302 53 1347 511 899
 1532 421 576 1269 238 398 448 1602 353 1647 811 1199 80 721 876 1569 538 698 748 150 653 195 1111 1499 380
 1021 1176 117 1048 495 838 1476 450 1411 47 1321 680 953 998 417 1348 795 1138 24 750 1711 347 1621 980 1253
 1298 717 1648 1095 1438 324 1050 259 647 169 1280 1553 1598

Table B-11: N = 1884

961 1193 1659 1588 1404 378 656 1702 487 633 683 170 1046 1325 1791 1720 1536 510 788 1834 572 765 815 208
 1178 1457 1641 1758 1198 595 1155 552 704 1273 947 340 1357 1589 1773 100 1800 774 1052 684 883 1405 1079 566
 1489 1721 303 232 48 906 1184 346 1015 1161 1211 698 1574 1853 153 270 1594 991 1551 948 1100 1293 1343 736 1753
 101 285 402 1726 1123 1683 1080 1279 1801 1475 962 1 233 699 628 444 1302 1580 742 1411 1557 1607 1094 86 365 831
 666 106 1434 63 874 1496 1689 1739 1132 218 497 681 798 238 1519 195 1476 1628 313 1871 1264 397 629 1095 1024
 840 1698 92 1138 1807 69 119 1490 482 761 1227 1156 972 1830 224 1270 8 201 251 1622 614 893 1077 1194 634 31 591
 1872 140 709 383 1660 793 1025 1209 1420 1236 210 488 120 319 841 515 2 925 1157 1623 1552 1368 342 620 1666
 451 597 647 134 1010 1289 1473 1590 1030 427 987 384 536 729 779 172 1189 1421 1605 1722 1162 559 1119 516 715
 1237 911 398 1321 1553 135 64 1764 738 1016 178 847 993 1043 530 1406 1685 267 102 1426 870 1383 310 932 1125
 1175 568 1538 1817 117 234 1558 955 1515 912 1064 1633 1307 700 1717 65 531 460 276 1134 1412 574 1243 1765 1439
 926 1802 197 663 592 408 1266 1544 706 1328 1521 1571 1058 50 329 513 630 70 1351 27 1308 1460 145 1703 1096 229
 461 645 856 672 1483 1808 1440 1639 277 1835 1322 361 593 1059 988 804 1662 56 1102 1771 33 83 1454 446 725 909
 1026 466 1747 423 1704 1856 165 215 1492 625 857 1041 1158 598 1879 555 1836 151 673 347 1624 757 989 1455
 1384 1200 174 452 1498 283 429 479 1850 842 1121 1587 1422 862 306 819 1630 368 561 611 4 974 1253 1437 1554
 994 391 951 348 500 1069 743 136 1153 1385 1851 1780 1596 570 848 10 679 1201 875 362 1238 1517 99 28 1728 702
 980 142 764 957 1007 494 1370 1649 1833 66 1390 787 1347 744 896 1465 1139 532 1549 1781 81 292 108 919 1244 876
 1075 1597 1271 758 1681 29 495 424 240 1098 1376 538 1207 1353 1403 890 1766 161 345 462 1786 1183 1743 1140 1292
 1485 1535 928 61 293 477 594 34 1315 1875 1272 1471 109 1667 1060 193 425 891 820 636 1494 1772 934 1603 1749
 1799 1286 278 557 1023 858 298 1626 255 1066 1688 1881 47 1324 410 689 873 990 430 1711 387 1668 1820 505 179
 1456 589 821 1287 1216 1032 6 284 1330 115 637 311 1682 674 953 1419 1348 1164 138 416 1462 200 393 443 1814
 1269 1386 1085 1852 223 806 901 332 826 783 180 575 1401 1612 1217 194 355 985 1033 511 1428 680 312 707
 1815 1744 1349 326 534 1117 789 643 1560 812 1858 839 1665 1782 1481 364 619 1202 921 728 1222 1179 576 971
 1797 30 1613 496 751 1381 1429 907 1354 1311 708 1103 327 256 1745 722 930 1513 1185 1039 72 1208 370 1235 459 294
 1877 760 1062 1598 1317 1124 1618 1340 502 1367 309 426 125 892 1147 1730 1825 1256 1750 1707 1104 1499 723 652 257
 1118 1326 25 73 1435 468 1604 766 1631 855 784 389 1250 1458 110 1713 1520 600 1736 898 1763 705 822 521 1288
 1543 242 337 1652 262 219 1500 11 837 1048 653 1514 1675 421 469 1831 864 116 1632 143 1251 1180 785 1646 1854
 553 225 79 996 248 1294 275 1101 1218 917 1684 55 638 357 164 658 615 12 407 1233 1350 1049 1816 187 817 865
 343 790 747 144 539 1647 1576 1181 158 366 949 621 475 1392 644 1690 671 1779 1614 1313 196 498 1034 753 560
 1054 776 1822 803 1629 1746 1445 328 583 1166 1261 692 1186 1143 540 935 159 88 1577 554 762 1345 1393 871 1788
 1040 202 1067 291 220 1709 686 894 1430 1149 956 36 1172 334 1199 141 258 1841 724 979 1562 1657 1088 1582 1539
 936 1331 273 484 89 950 1111 1741 1789 1267 300 1671 1068 1463 687 616 221 1082 1290 1873 1545 1399 432 1568 730
 1595 537 654 353 1120 1375 74 1677 1484 94 51 1332 1727 669 786 485 1252 1507 253 301 1663 226 183 1464 1859 1083
 1012 617 1478 1686 385 57 1795 828 80 1126 107 1215 1050 749 1516 1818 470 189 1880 490 212 1258 239 1065 1182 881

1648 19 602 697 128 622 579 1860 371 1479 1408 1013 1874 198 781 829 307 1224 476 1522 503 1611 1540 1145 122
 330 866 585 392 1356 608 1654 635 1461 1578 1277 160 415 998 1093 524 1018 975 372 767 1593 1804 1409 386 547
 1177 1225 703 1620 1107 504 899 123 52 1541 518 726 1309 981 835 1752 1004 166 1031 1857 90 1673 556 811 1394
 1113 920 1414 1371 768 1163 105 222 1805 688 943 1573 1621 1099 1546 1503 900 1295 519 448 53 914 1122 1705 1377
 1231 264 1400 562 1427 651 486 185 952 1254 1790 1509 1316 1810 1532 694 1559 501 618 317 1084 1339 38 133 1448
 58 15 1296 1691 844 449 1823 660 958 265 217 1627 1518 1796 915 1310 976 581 71 792 1090 21 302 1712 1650 44 1047
 1442 203 1480 411 1844 897 434 1735 1014 713 1692 454 529 335 1706 543 139 1029 613 1867 1240 845 1824 1056 661
 467 1838 440 271 1443 745 162 1372 977 1486 1188 417 599 1876 807 356 1575 830 247 1410 1109 204 850 549 731
 124 939 535 1425 1009 379 1542 1241 336 982 1057 863 350 836 667 1839 1141 558 1768 1373 1882 1584 813 995 388
 968 752 87 1226 690 1806 1505 130 1716 945 1127 520 1335 884 1821 1358 775 54 1637 732 1378 1453 1259 746 1232
 1063 351 1537 954 280 1769 394 96 1585 1391 878 1364 1148 483 1669 1086 412 17 526 228 1341 1523 916 1731 1280 333
 1754 1171 450 149 1128 1774 1849 1655 1142 1863 1459 465 49 1303 676 281 1260 492 97 1787 1274 1760 1591 879 181
 1482 808 413 922 624 1737 35 1312 243 1676 1011 266 1567 846 545 1524 286 1869 167 1444 375 1855 861 445 1699
 978 677 1656 418 493 299 1670 272 103 1275 577 1878 1204 809 1318 1020 249 431 1708 404 188 1407 662 126
 1242 941 1450 1152 381 563 1840 771 320 1257 794 211 1374 1073 168 814 889 695 182 668 499 1389 973 390
 1600 1205 1714 1416 1021 827 314 800 584 1803 1105 522 1732 1337 1846 1548 777 959 352 1167 716 1653 1190 607
 1770 1469 564 1210 1285 1091 578 1299 895 1785 1369 739 112 1601 696 1342 1417 1223 710 1196 1027 315 1501 918 244
 1733 358 60 1173 1355 748 1563 1112 447 1586 1003 282 1865 960 1606 1305 1487 880 1695 1291 297 1718 1135 414 113
 1092 1738 1813 1619 1106 1592 1423 711 13 1314 640 245 754 456 1569 1751 1144 1724 1508 843 98 1446 678 377 886 588
 1701 1883 1276 207 1640 693 230 1531 810 509 1488 250 325 131 1502 104 1819 825 409 1710 1036 641 1150 852 457
 263 1634 236 20 1239 541 1842 1168 773 1282 984 213 395 1672 603 152 1089 626 43 1206 905 0 646 721 527 14 735
 331 1221 805 175 1432 1037 132 778 853 659 146 632 463 1635 937 354 1564 1169 1678 1380 609 791 184 999 548
 1767 1022 439 1602 1301 396 1042 741 923 316 1131 727 1617 1154 571 1734 1433 528 1174 1249 1055 542 1028 859 147
 1333 750 76 1565 190 1776 1005 1187 580 1160 944 279 1418 882 114 1697 322 24 1137 1319 712 1527 1076 129 1550 967
 246 1829 924 1570 1645 1451 938 1424 1255 261 1729 1146 472 77 586 288 1777 1556 1861 420 1533 1583 209 1278 718
 675 1387 604 1070 39 62 82 157 1715 341 1363 1320 525 1472 642 1108 171 241 214 289 1847 473 1495 1452 657 1651
 868 1334 68 373 816 45 95 605 1674 1114 1071 1783 1000 1466 435 458 478 177 227 737 1759 1246 1203 1868 1038 1504
 567 590 610 685 359 869 7 1848 1053 163 1170 1636 464 769 1212 441 491 1001 186 1510 1467 295 1396 1862 596
 854 1344 573 623 1133 318 1642 1599 380 1528 16 963 986 1006 1081 755 1265 403 360 1449 512 1566 148 860 1165
 1608 1213 887 1397 582 22 1581 691 1792 374 992 1297 1740 969 1019 1529 714 154 111 823 40 506 1359 1382 1402
 1477 1151 1661 799 756 1845 908 78 544 1491 1561 1534 1609 1283 1793 931 888 93 1087 304 770 1388 1693 252 1365
 1415 41 1110 550 507 1219 436 902 1755 1778 1798 1497 1547 173 1195 682 639 1304 474 940 3 26 46 121 1679 305
 1327 1284 489 1436 606 1072 1784 205 648 1761 1811 437 1506 946 903 1615 832 1298 32 290 780 9 59 569 1638 1078
 1035 1700 964 1336 399 422 442 517 191 701 1723 1680 885 1832 1002 1468 296 601 1044 649 323 833 18 1812 1017
 127 1228 1694 428 733 1176 405 455 965 150 1474 1431 259 1360 1826 795 818 838 913 587 1097 235 192 1281 344
 1398 1864 927 997 970 1045 719 1229 367 324 1413 523 1530 206 824 1129 1572 801 851 1361 546 1870 1827 655
 1756 338 1191 1214 1234 933 983 1493 631 118 75 740 1794 376 1323 1346 1366 1441 1115 1625 763 720 1809 872 42 508
 1220 1525 84 1197 1247 1757 942 382 339 1051 268 734 1352 1610 216 1329 1379 5 1074 514 471 1136 400 772 1719
 1742 1762 1837 1511 137 1159 1116 321 1268 438 904 1616 37 480 85 1643 269 1338 1248 453 1447 664 1130 1748 169 612
 1725 1775 401 1470 910 867 1579 796 1262 231 254 274 349 23 533 1555 1512 717 1664 834 1300 363 433 406 481
 155 665 1687 1644 849 1843 966 1526 260 565 1008 237 287 797 1866 1306 1263 91 1192 1658 627 650 670 369 419
 929 67 1438 1395 176 1230 1696 759 782 802 877 551 1061 199 156 1245 308 1362 1828

Table B-12: N = 2052

1948	410	1319	1341	115	83	658	1560	771	486	1673	1582	1240	1754	611	633	1459	943	2002	852	63	1196	965	874	532	112	
1955	1977	751	235	1928	144	1407	488	257	1901	1876	1456	930	1269	1945	1579	1220	1488	699	414	1284	1193	50	1682	222		
561	1237	871	512	313	2043	1758	576	485	1394	974	1883	1905	529	647	1856	1657	1335	1050	1920	94	686	266	1175	1197		
1873	1991	514	949	627	342	1529	1438	1096	1610	467	489	1315	1283	1858	708	1971	1052	821	730	388	2020	1811	1833	607		
91	1150	0	1263	344	113	22	1732	1312	786	1125	1951	1435	1076	1344	555	1688	1457	1049	1024	604	78	417	1093	727	368	636
1899	1614	432	341	1250	830	1422	1761	385	19	1712	1513	1191	906	1776	1685	542	122	1031	1053	1729	1847	1004	805	483		
198	1068	1294	1886	1466	323	345	1021	1139	1714	564	1827	1542	677	586	244	758	1667	1689	463	1999	1006	1908	1119	200		
2021	1930	1588	1168	959	981	1807	1291	932	1200	411	1544	1313	1222	880	460	1986	273	1099	583	224	492	1755	836	605		
197	172	1804	1278	1617	241	1927	1568	1369	1047	762	1632	1541	398	2030	570	909	1585	1703	860	661	339	54	924	833		
1742	1322	179	201	877	995	1570	2005	1683	1398	216	442	1034	614	1523	1545	169	287	862	1764	975	690	1877	1786			
1444	1958	815	837	1663	1147	154	1056	267	1400	1169	1078	736	316	107	129	955	439	80	348	1611	692	461	370	28		
1660	1134	1473	97	1783	1424	1692	903	2036	1805	1397	1372	952	426	765	1441	1075	716	517	195	1962	780	689	1598	1178		
1770	57	733	851	8	1861	1539	1254	72	298	890	470	1379	1401	25	143	718	1153	831	546	1416	1642	182	1814	671	693	
1519	1487	10	912	123	1890	1025	934	592	1106	2015	2037	811	295	1354	204	1467	548	317	226	1936	1516	1307	1329	103		
1639	1280	1548	759	1892	1661	1253	1228	808	282	621	1297	931	572	840	51	1184	953	545	520	100	1626	1965	589	223		
1916	1717	1395	1110	1980	1889	746	326	918	1257	1933	2051	1208	1009	687	402	1272	1498	38	1670	527	549	1225	1343	1918		
301	2031	1746	881	790	448	962	1871	1893	667	635	1210	60	1323	1038	173	82	1792	254	1163	1185	2011	1495	502	1404	615	
1748	1517	1426	1084	664	455	477	1303	787	428	696	1959	1040	809	401	376	2008	1482	1821	445	79	1772	2040	1251	332		
1836	1745	602	1300	774	1113	1789	1423	1064	865	543	258	1128	1037	1946	1526	66	405	1081	1199	356	157	1887	1602	420		
646	1238	818	1727	1749	373	491	1066	1501	1179	894	29	1990	1648	110	1019	1041	1867	1835	358	1260	471	186	1373	1282		
940	1454	311	333	1159	643	1702	552	1815	896	665	574	232	1864	1655	1677	451	1987	1628	1896	1107	188	2009	1601			
1576	1156	630	969	1645	1279	920	1188	399	114	984	893	1802	1382	1974	261	937	571	212	13	1743	1458	276	185	1266		
1605	674	1846	347	1094	750	1035	229	1556	1357	1620	875	897	2018	1138	1691	386	42	327	1573	214	649	1229	167	189		
1310	430	983	796	752	1671	1015	1558	408	521	1511	1533	1720	1774	1843	88	44	963	307	850	1752	1865	803	825	1012	749	
1135	1432	1388	255	1651	776	1044	1157	1830	117	304	41	427	724	1314	1599	793	68	336	132	1122	1461	530	1385	1771	950	
606	891	85	1412	1213	1476	731	753	1874	994	1547	242	1950	183	1429	704	505	768	23	45	1166	286	839	1586	1242	1527	
721	1414	264	377	1367	1389	458	1630	1699	1996	1952	819	163	706	1608	1721	659	681	868	922	991	1288	1244	111			
1507	2050	900	1013	1686	2025	160	1949	283	580	536	1455	799	1976	192	305	978	1317	1504	1241	1627	1924	462	747			
1993	1268	1069	1332	270	609	1730	533	1403	98	1806	39	1285	560	361	624	1931	1953	1022	142	695	1442	1098	1383	577		
1904	1705	1968	1223	1245	314	1486	2039	734	390	675	1921	562	1464	1577	515	537	1658	778	847	1144	1100	2019	1363			
1906	756	869	1859	1881	16	70	139	436	392	1311	655	1832	48	161	834	1173	1360	1097	1483	1780	1736	603	1849	1124	1392	
1505	126	465	652	389	775	1072	1662	1947	1141	416	217	480	1470	1809	878	1733	551	1298	954	1239	433	1760	1561			
1824	1079	1101	170	1342	1895	590	246	531	1777	418	853	1116	371	393	1514	634	1187	1934	1590	1875	1219	1762	612	725		
1715	1737	806	1978	2047	292	248	1167	511	1054	1956	17	1007	1029	1216	1270	1339	1636	1592	459	1855	980	1248	1361	2034		
321	508	245	631	928	884	1803	997	272	540	653	1326	1665	1852	1589	1975	220	810	1095	289	1616	1417	1680	618	957		
26	1198	1751	446	102	387	1633	908	709	972	227	249	1370	490	1043	1790	1446	1731	925	1618	1	581	1571	1593	662		
1834	335	148	738	1023	367	910	1812	1925	863	885	2006	1126	1195	1492	1448	315	1711	202	1104	1217	155	177	364	101		
487	784	740	1659	1003	128	396	509	1182	1521	1708	1445	1831	76	32	951	145	1472	1740	1536	474	813	1000	737	1123	302	
2010	243	1489	764	565	828	1818	105	1226	346	899	1646	1302	1587	781	56	1909	120	1427	1449	518	1690	191	938	594		
879	73	766	1201	1781	719	741	1862	982	1535	1348	1938	171	1567	58	960	1073	11	33	1154	274	343	640	596	1515	859	
1402	252	365	1355	1377	1564	1301	1687	1984	1940	807	151	1328	1596	1709	330	669	856	593	979	1276	1866	99	1345	620		

888 684 1674 2013 1082 1937 271 1502 1158 1443 637 1964 1765 2028 966 1305 374 1546 47 794 450 735 1981 1256 1057
 1320 575 597 1718 838 1391 86 1794 27 1273 1966 349 929 1919 1941 1010 130 683 496 452 1371 715 1258 108 221
 1420 1565 550 663 1452 1796 7 1211 1233 1543 1474 1840 712 857 476 2007 744 1088 1351 503 525 835 449 1132 4
 1884 1820 1299 36 1014 493 1530 1869 127 1793 424 230 1176 1112 591 913 306 1837 822 1161 1471 1085 650 1574 468
 404 1935 205 1650 1129 431 453 1247 694 1994 866 77 1114 1227 2016 942 421 1775 1797 539 2038 1286 158 1421 406
 519 1308 1652 1915 1067 1089 1399 1330 1696 568 713 1750 1863 600 944 1207 359 381 691 622 988 1912 5 1676 1155
 1944 236 499 1386 1725 2035 1649 280 1204 1032 968 447 769 162 1693 678 1017 1327 941 1624 324 233 260 1791
 2022 1850 1103 309 1430 61 985 1506 1668 1894 1604 1083 1631 1142 395 1653 722 1405 277 798 1277 1186 262 375 923
 434 1739 945 14 1164 1621 90 569 478 1606 1719 215 844 547 237 1358 456 1063 800 1913 1822 1532 1011 1559 136
 1891 1581 1768 1800 355 92 1205 797 824 303 534 1480 1183 873 1060 1092 1549 1436 180 89 116 1647 1878 772 475 165
 352 1969 841 1362 1524 1433 1460 939 1170 998 251 1509 578 1261 133 654 816 1042 118 231 779 290 1595 801
 1922 553 1477 1998 425 334 1462 1575 71 1634 887 93 1214 312 919 1290 1769 1678 754 867 1415 2044 1747 1437 506
 1656 211 2000 1061 970 680 159 707 1336 1039 729 916 948 1555 1292 353 1997 2024 1503 1734 628 331 21 208 240
 697 584 1380 1289 1316 795 1026 1972 1675 1365 1552 1117 2041 510 672 898 608 87 318 146 1451 657 1778 409 1333
 1854 281 190 1318 1431 1979 1490 743 2001 1070 1753 625 1146 1625 1534 610 723 1271 782 35 1293 362 1512 67 438 917
 826 1954 15 563 1192 895 585 1706 804 1411 1148 209 1853 1880 1359 1907 484 187 1929 64 96 703 440 1236 1145 1172
 651 882 1828 1531 1221 1408 1440 1897 1784 528 437 464 1995 174 1120 823 513 700 265 1189 1710 1872 46 1808 1287
 1518 1346 599 1857 926 1609 481 1002 1481 1390 466 579 1127 638 1943 1149 218 901 1825 294 773 682 1810 1923 419
 1048 1235 441 1562 660 1267 1638 65 2026 1102 1215 1763 340 43 1785 854 2004 559 296 1409 1001 1028 507 1055 1684
 1387 1077 1264 1296 1903 1640 384 293 320 1851 30 976 679 369 556 588 1045 1566 1728 1637 1664 1143 1374 1202 2023
 1713 1900 1465 337 858 1020 1246 956 435 666 494 1799 1005 74 757 1681 150 629 538 1666 1779 275 1838 1091 297
 1418 49 973 1494 1973 1882 958 1071 1619 196 383 1641 710 1860 415 152 1265 1174 250 363 911 1540 1243 933 2
 1152 1759 1496 176 832 1051 788 557 412 535 444 203 1707 225 149 1520 124 193 714 1584 1756 1879 1788 1230 999
 1569 1493 812 350 1537 6 876 1982 1171 613 522 291 861 785 104 1694 829 1350 168 1274 947 1957 131 1635 153
 394 814 986 121 642 1829 566 239 1716 1475 927 1497 1738 106 1396 1615 1352 1121 1910 1583 1008 767 219 789
 1030 1450 688 907 644 413 268 391 300 59 1563 81 322 1376 2032 199 1988 1757 1612 1735 1644 1086 855 1425 1349 668
 1324 1393 1914 732 904 1027 469 378 147 717 641 2012 1550 685 1206 24 1130 319 1813 1722 1491 9 1985 1304 842
 2029 498 1368 422 95 1105 1331 783 1353 1594 2014 134 1321 1842 977 1766 1439 864 623 75 645 886 1306 544 763 500
 269 1058 247 156 1967 1419 1989 178 1232 1888 55 1844 1613 1468 1591 1500 1259 711 1281 1522 524 1180 1249 1136 905
 760 883 792 234 3 573 497 1868 472 541 1062 1932 52 175 1669 1578 1347 1917 1841 1160 698 1885 354 1224 278
 2003 961 870 639 1209 1133 1870 2042 1177 1698 516 1622 1295 253 479 1983 501 742 1162 1334 619 990 125 914 587
 12 1823 1275 1845 34 454 1744 1963 1700 1469 206 1447 1356 1115 567 1137 1378 380 1036 1255 992 761 616 739 648 407
 1911 429 670 1724 328 397 284 53 1960 31 1992 1434 1203 1773 1697 1016 1672 1741 210 1080 1252 1375 817 726 495
 1065 989 308 1898 1033 1554 372 1478 1151 109 18 1839 357 598 1018 1190 325 846 2033 770 443 1453 1679 1131 1701
 1942 310 482 1819 138 1325 62 1787 1212 971 423 993 1234 1654 892 1111 848 617 1406 595 504 263 1767 285 526
 1580 184 403 140 1961 1816 1939 1848 1607 1059 1629 1553 872 1528 1597 1484 936 1108 1231 1140 582 351 921 845 164
 820 889 1410 228 400 523 2017 1926 1695 213 137 1508 1046 181 702 1572 626 299 1309 1218 987 1557 1798 166 338
 1525 2046 1181 1970 1643 601 827 279 849 1090 1510 748 967 1338 473 1262 935 360 119 1623 141 382 802 40 259
 2048 1817 554 1795 1704 1463 915 1485 1726 728 1384 1603 1340 1109 964 1087 996 755 207 777 701 20 676 745 632
 84 256 379 288 1782 1551 69 2045 1364 902 37 558 1428 1600 1723 1165 1074 843 1413 1337 656 194 1381 1902 720 1826
 1499 457 366 135 705 946 1366 1538 673 1194 329 1118 791 1801 2027 1479 2049 238

Table B-13: N = 2259

NOTE: The interleaver permutations for N = 2259 are obtained by first computing the interleaver permutations for N = 2256 and then inserting $\pi(21) = 2258, \pi(121) = 2257, \pi(221) = 2256. \pi(21) = 2258, \pi(121) = 2257, \pi(221) = 2256.$

317	507	1067	836	1226	226	489	1686	698	67	2251	29	2161	807	2020	1136	576	764	789	383	1948	2258	367	1542	1932	917
1107	64	1198	1826	826	1089	30	1298	1261	595	629	505	1407	364	1736	1176	1364	1389	983	292	967	2142	276	1517	1707	664
1798	170	1426	1689	630	1898	1861	186	1229	1105	2007	311	80	1776	1726	1989	1583	892	1567	1495	876	2117	51	1264	142	770
2026	33	1230	242	205	786	1829	1705	351	911	680	120	70	333	2183	542	2167	2095	1476	461	651	1864	742	420	608	633
1830	1792	805	1386	173	49	951	1511	1280	720	670	933	527	1142	511	439	2076	2257	1061	1251	208	1342	1020	1208	1233	
174	136	1405	1986	773	649	1551	2111	1880	14	1270	1533	1127	1742	1111	1039	1073	1661	1851	808	1942	1620	1808	1833	774	
736	2005	330	1373	1249	2151	455	224	614	1870	2133	1727	86	1711	1639	1673	1549	195	1408	286	2220	152	177	2027	1336	
349	930	1320	305	495	1055	824	1214	214	477	1674	686	55	2239	17	2149	795	2008	886	564	752	777	371	1936	949	
1530	1920	905	1095	1655	1424	1814	814	1077	18	1286	655	583	617	493	1395	352	2256	1486	1164	1352	1377	971	280	955	
2130	264	1505	1695	2255	2024	158	1414	1677	618	1886	1849	1183	1217	1093	1995	952	68	1764	1952	1977	1571	880	1555	474	
864	2105	39	1252	130	758	2014	21	1218	230	193	1783	1817	1693	339	899	668	108	296	321	2171	1480	2155	1074	1464	449
639	1852	730	1358	358	621	1818	830	793	1374	161	37	939	1499	1268	708	658	921	515	2080	499	427	2064	1049	1239	
196	1330	1958	1196	1221	162	1430	1393	1974	761	637	1539	2099	1868	1308	1258	1521	1115	1730	1099	1027	408	1649	1839	796	
1930	1608	1796	1821	762	724	1993	318	1361	1237	2139	443	212	602	1858	2121	1715	74	1699	1627	1008	2249	183	1396	274	
2208	140	165	1362	1324	337	918	1961	1837	483	1043	812	1202	202	465	59	674	43	2227	5	593	783	1996	874	552	740
765	1962	1924	937	1518	1908	181	1083	1643	1412	1802	802	1065	659	1274	643	571	605	481	1383	340	1474	1152	1340		
1365	959	268	1537	2118	252	1493	1683	2243	2012	146	1402	1665	606	1874	1243	1171	1205	1081	1983	940	2074	1752	1940		
1965	1559	868	2137	462	852	2093	27	587	356	746	2002	9	1206	218	1843	1771	1805	1681	327	1540	418	96	284	309	2159
1468	2143	1062	1452	437	627	1187	956	1346	346	609	1806	818	781	115	149	25	927	2140	1256	696	884	909	503	2068	
487	1662	2052	1037	1227	184	1318	1946	946	1209	150	1418	1381	715	749	625	1527	2087	1856	1296	1484	1509	1103	412		
1087	6	396	1637	1827	784	1918	290	1546	1809	750	2018	1981	306	1349	1225	2127	431	200	1896	1846	2109	1703	1012	1687	
1615	996	2237	171	1384	262	890	128	153	1350	362	325	906	1949	1825	471	1031	800	240	190	453	47	662	31	2215	
1596	581	771	1984	862	540	728	753	1950	1912	925	1506	293	169	1071	1631	1400	1790	790	1053	647	1262	631	559		
2196	328	1462	1371	893	1328	1181	1525	256	1140	1353	294	2106	2231	2000	1671	1193	1390	769	1231	1862	134	1653	1247		
1159	928	2062	1971	840	1928	1781	2125	856	1740	1953	894	450	575	344	15	1793	1990	1369	1831	206	734	2253	1847	1759	
1528	406	315	1440	272	1669	469	1456	84	297	2147	1050	1175	944	615	137	334	425	175	806	1334	597	1794	103	2128	
1006	915	2040	872	13	1069	2056	684	897	491	1650	1775	1544	1215	737	934	1025	775	1406	1934	1197	138	703	472	1606	
1515	384	1472	613	1075	400	1284	1497	1091	2250	119	2144	1815	1337	1534	1625	1969	2006	278	1797	738	1303	1072	188		
2115	984	2072	1213	1675	1000	1884	2097	1691	594	1372	250	159	1937	2134	2225	313	350	878	141	1338	1903	1019	788	459	
1584	416	1813	19	1600	228	441	35	1194	1972	850	759	281	478	569	913	950	1478	741	1938	1494	1619	1388	1059	2184	778
157	619	2200	828	1041	635	547	316	1450	1359	881	1316	1169	1513	1550	2078	1341	282	2094	2219	1988	1659	528	1378	757	
1219	1850	1428	1641	1235	1147	916	2050	1959	1481	1916	1769	2113	844	1728	1941	882	438	563	332	3	1128	1978	1357	1819	
194	722	2241	1835	1747	1516	394	303	2081	260	113	457	1444	72	285	1482	1038	1163	932	603	125	322	1957	163	794	
1322	585	179	91	2116	994	903	2028	860	713	1057	2044	672	885	2082	1638	1763	1532	1203	725	922	301	763	1394	1922	
1185	779	691	460	1594	1503	372	1460	601	1657	388	1272	1485	1079	2238	107	2132	1803	1325	1522	1613	1363	1994	266		
1785	726	1291	1060	2194	2103	972	2060	1201	1	988	1872	2085	1679	582	707	476	147	1925	2122	2213	1963	338	866	129	
1326	1891	1660	538	447	1572	404	1801	7	1588	216	429	23	1182	1307	1076	747	269	466	557	901	938	1466	729	1926	235
4	1376	1047	2172	1004	145	607	2188	816	1029	623	1782	304	1438	1347	869	1066	1157	1501	1538	2066	1329	270	835	2207	

1976 1647 516 1604 745 1207 532 1416 1629 1223 126 904 2038 1947 1469 1666 1757 2101 2138 410 1929 870 426 551 320
 2247 1116 1966 1345 1807 1132 2016 2229 1823 1735 1504 382 291 2069 248 101 445 482 1010 273 1470 1026 1151 920 591
 1716 310 1945 151 782 360 573 167 79 2104 982 891 413 848 701 1045 2032 660 873 2070 1626 1751 1520 1191 60 910
 289 751 1382 1910 1173 767 679 448 1582 1491 1013 1448 1301 1645 376 1260 1473 414 2226 95 2120 1791 1313 1510 889
 1351 1982 254 1773 1367 1279 1048 2182 2091 960 2048 1901 2245 976 1860 2073 1667 570 695 464 135 1913 2110 1489
 1951 326 854 117 1967 1879 1648 526 435 1560 392 1789 589 1576 204 417 11 1170 1295 1064 735 257 454 545 295
 926 1454 717 1914 223 2248 1126 1035 2160 992 133 1189 2176 804 1017 611 1770 1895 1664 1335 857 1054 1145 895
 1526 2054 1317 258 823 592 1964 1635 504 1592 733 1195 520 1404 1617 1211 114 239 8 1935 1457 1654 1745 2089 2126
 398 1917 858 1423 2235 714 2217 1120 1811 1795 2004 1192 308 2192 1104 1333 279 1014 261 470 1458 433 998 1492 370
 2254 2057 89 579 1314 561 1720 155 139 348 1139 908 536 1704 1933 879 1614 861 1070 2058 1033 1598 2092 970 598
 401 689 667 48 1161 1370 1739 277 898 1508 1179 755 948 739 2214 1001 1461 1670 436 1289 1436 1570 1479 402 2198
 1633 1267 648 1761 1970 83 877 1498 2108 1779 1355 1548 1339 558 1601 2061 964 1036 1889 2036 2170 2079 1002 1848 2233
 1867 1248 105 314 683 1477 2098 452 123 1955 842 1939 1158 2201 405 1564 1636 233 380 514 423 1602 192 577 211
 245 705 914 1283 2077 442 1052 723 299 1442 283 1758 2148 1005 2164 2236 833 980 1114 1023 599 792 1177 811 845
 1305 1514 1883 421 1042 1652 1323 246 2042 883 102 492 1605 508 580 721 1580 1714 1623 1199 1392 1777 1411 1445
 1905 2114 227 1733 1642 2252 1923 846 386 1483 702 1092 2205 1108 1180 1321 2180 58 2223 1799 1992 121 2011 2045 249
 458 827 77 2242 596 267 1446 986 2083 1302 1692 549 1708 1780 1921 524 896 567 143 336 127 355 389 849 1058
 1427 677 586 958 867 2046 1586 1021 1902 36 1149 52 124 265 1124 1496 1167 743 936 727 2202 989 1449 1658 424
 1277 1186 1558 1467 390 2186 1621 1255 636 1749 652 71 865 1724 2096 1767 1343 1536 1327 546 1589 2049 2 1024 1877
 1786 2158 2067 990 530 2221 1855 1236 93 302 671 1465 2086 440 111 1943 2136 1927 1146 2189 393 1552 1624 221 368
 502 411 1590 1130 565 199 1836 693 902 1271 2065 430 1040 711 287 480 271 1746 533 993 2152 2224 821 968
 1102 1011 2190 780 1165 799 180 1293 1502 1871 409 1030 1640 1311 887 2030 871 90 1133 1593 496 568 1421 1568 1702
 1611 534 1380 1765 1399 1433 1893 2102 215 1009 1630 2240 1911 1487 374 1471 690 1080 2193 1096 1168 2021 2168 46 2211
 1787 1980 109 1999 2033 237 446 815 1609 2230 584 255 1434 974 2071 1290 1680 537 1696 1768 1909 512 646 555 131
 324 709 343 377 837 1046 1415 665 574 1184 855 2034 1574 415 1890 24 1137 40 112 253 1112 1246 1155 731 924
 1309 943 977 1437 1646 2015 1265 1174 1784 1455 378 2174 1015 234 624 1737 640 712 853 1712 2084 1755 1331 1524
 1315 1543 1577 2037 2246 359 1865 1774 2146 2055 978 518 2209 834 1224 81 1240 1312 1453 56 428 99 1931 2124 1915 1134
 2177 381 590 1612 209 118 490 399 1578 1118 553 187 1824 681 1840 1259 2053 656 1028 699 275 468 259 1734 521
 981 1190 2212 809 718 1090 999 2178 1718 1153 787 168 1281 1490 1859 397 1018 1628 1299 875 1068 859 78 1121 1581
 484 556 1409 1556 1690 1599 522 62 1753 1387 768 1881 2090 203 997 1618 2228 1899 1475 1668 1459 678 1721 2181 1084
 1156 2009 2156 34 2199 1122 1968 97 1987 1368 225 434 803 1597 2218 572 243 2075 962 2059 1278 65 525 1684 1756 353
 500 634 543 1722 312 697 825 2197 1562 403 331 843 562 419 1403 1034 1172 365 1125 953 912 1297 1878 1143
 1100 719 100 28 1234 12 1425 541 2162 1003 931 1443 1162 366 2003 1634 1772 965 1725 841 1512 1897 222 1743 1700
 1319 700 628 1834 612 2025 1853 506 1603 1531 2043 1762 966 347 2234 116 1565 69 1441 2112 241 822 87 44 1919 1300
 1228 178 1212 369 197 1106 2203 2131 387 106 1566 947 578 716 2165 669 2041 456 247 1422 687 644 263 1900
 1828 1016 1812 969 797 1706 1141 475 987 706 2166 1547 1178 1078 509 1269 385 1056 847 2022 1287 1244 863 244 172
 1616 156 1569 1397 50 1741 66 1587 1306 510 544 1778 1678 1109 1869 985 1656 1447 1375 1887 1844 1463 191 772 2216 756
 2169 1997 650 85 666 2187 1906 1110 1144 122 22 1709 213 1585 0 2047 1975 231 2206 2063 791 422 560 1356 513 341
 1250 685 1266 531 488 1710 1744 1672 622 53 813 2185 600 391 319 831 550 407 1391 1022 1160 1956 1113 941 900
 1285 1866 1131 1088 54 88 16 1222 653 1413 529 2150 991 919 1431 1150 1007 1991 1622 1760 300 1713 1541 1500 1885 210
 1731 1688 654 688 616 1822 1253 2013 1129 494 1591 1519 2031 1750 1607 335 2222 104 1553 57 2141 2100 229 810 75 32
 1907 1288 1216 166 1200 357 1729 1094 2191 2119 375 94 1554 935 566 704 2153 657 2029 444 829 1410 675 632 251
 1888 1816 766 1800 957 785 1694 535 463 975 694 2154 1535 1166 1304 497 1257 373 1044 1429 2010 1275 1232 851 232

160 1366 144 1557 1385 38 1135 1063 1575 1294 498 2135 1766 1904 1097 1857 973 1644 1435 354 1875 1832 1451 832 760
 2204 744 2157 1985 638 73 1663 2175 1894 1098 479 110 10 1697 201 1573 2244 2035 954 219 176 2051 1432 1360 548
 1344 501 329 1238 673 1254 519 238 1698 1732 710 610 41 801 2173 588 379 307 819 776 395 1379 1960 1148 1944
 1101 929 1838 1273 1854 1119 838 42 76 1310 1210 641 1401 517 1188 979 907 1419 1138 995 1979 1610 1748 288 1701
 1529 182 1873 198 1719 1676 642 676 604 1810 1241 2001 1117 1788 1579 1507 2019 1738 1595 323 2210 92 888 45 2129
 2088 217 798 63 20 1242 1276 1204 154 1841 345 1717 1082 2179 2107 363 82 2195 923 554 692 1488 645 473 432 817
 1398 663 620 1842 1876 1804 754 185 945 61 1682 523 451 963 682 539 1523 1154 1292 485 1245 361 1032 1417 1998
 1263 1220 839 220 148 1354 132 1545 661 26 1123 1051 1563 1282 486 2123 1754 1892 1085 1845 961 1632 2017 342 1863
 1820 1439 820 748 1954 732 2145 1973 626 1723 1651 2163 1882 1086 467 98 236 1685 189 1561 2232 2023 942 207 164
 2039 1420 1348 298 1332

Table B-14: N = 3012

945 1581 1229 73 1147 646 294 516 593 487 815 1408 2145 2781 2429 1273 2588 1846 1494 1716 1793 2892 2015 2608 333
 969 617 2473 776 34 2694 2916 2993 1080 203 796 1533 1928 1817 902 1976 1234 882 1104 1181 2280 1403 1996 2733 116
 5 2102 164 2434 2082 2304 2381 468 2603 184 921 1316 603 290 1364 622 270 492 569 1668 791 1384 2121 2516 1803
 1490 2564 1822 1470 1692 1769 2868 1991 2584 309 704 3003 2690 752 10 2670 1446 2969 1056 661 772 1509 1904 1191 878
 1952 1210 858 2646 1157 2256 1861 1972 179 92 2391 2078 140 2410 2058 834 2357 444 49 160 1379 1292 579 266 1340 598
 246 2034 545 1644 1249 1360 2579 2492 1779 1466 2540 1798 362 222 1143 2844 2449 2560 767 680 2979 2666 728 2998
 1562 1422 2343 1032 637 748 1967 1880 1167 854 1687 1186 2762 2622 531 2232 1837 1948 155 68 2367 2054 2887 2386 950
 810 1731 2227 25 136 1355 1268 555 1 1075 574 2150 2010 2931 415 1225 1336 2555 2709 1755 1201 2275 1774 338 198
 1119 1615 2425 2536 743 897 2955 2401 463 2974 1538 1398 2319 2815 613 724 1943 2097 1745 589 1663 1162 2738 2598 507
 1003 1813 1924 131 285 2945 1789 2863 2362 926 786 1707 2203 2531 112 1331 1485 1133 2989 1051 550 2126 420 2907 391
 719 1312 2049 2685 2333 1177 2251 1750 314 1620 1095 1591 1919 2512 237 873 521 2377 439 2950 1514 2820 2295 2791 107
 700 1437 2073 1721 565 1639 1138 2714 1008 1085 979 1307 1900 2637 261 2921 1765 2839 2338 1986 2208 2285 2179 2507 88
 825 1461 1109 2965 1027 526 174 396 473 367 695 1288 2025 2661 2309 1153 2468 1726 1374 1596 1673 2772 1895 2488 213
 849 497 2353 656 2926 2574 2796 2873 960 83 676 1413 1808 1697 782 1856 1114 762 984 1061 2160 1283 1876 2613 3008
 2897 1982 44 2314 1962 2184 2261 348 2483 64 801 1196 483 170 1244 502 150 372 449 1548 671 1264 2001 2396 1683
 1370 2444 1702 1350 1572 1649 2748 1871 2464 189 584 2883 2570 632 2902 2550 1326 2849 936 541 652 1389 1784 1071 758
 1832 1090 738 2526 1037 2136 1741 1852 59 2984 2271 1958 20 2290 1938 714 2237 324 2941 40 1259 1172 459 146 1220 478
 126 1914 425 1524 1129 1240 2459 2372 1659 1346 2420 1678 242 102 1023 2724 2329 2440 647 560 2859 2546 608 2878
 1442 1302 2223 912 517 628 1847 1760 1047 734 1567 1066 2642 2502 411 2112 1717 1828 35 2960 2247 1934 2767 2266 830
 690 1611 2107 2917 16 1235 1148 435 2893 955 454 2030 1890 2811 295 1105 1216 2435 2589 1635 1081 2155 1654 218 78 999
 1495 2305 2416 623 777 2835 2281 343 2854 1418 1278 2199 2695 493 604 1823 1977 1625 469 1543 1042 2618 2478 387 883
 1693 1804 11 165 2825 1669 2743 2242 806 666 1587 2083 2411 3004 1211 1365 1013 2869 931 430 2006 300 2787 271 599
 1192 1929 2565 2213 1057 2131 1630 194 1500 975 1471 1799 2392 117 753 401 2257 319 2830 1394 2700 2175 2671 2999 580
 1317 1953 1601 445 1519 1018 2594 888 965 859 1187 1780 2517 141 2801 1645 2719 2218 1866 2088 2165 2059 2387 2980 705
 1341 989 2845 907 406 54 276 353 247 575 1168 1905 2541 2189 1033 2348 1606 1254 1476 1553 2652 1775 2368 93 729 377
 2233 536 2806 2454 2676 2753 840 2975 556 1293 1688 1577 662 1736 994 642 864 941 2040 1163 1756 2493 2888 2777
 1862 2936 2194 1842 2064 2141 228 2363 2956 681 1076 363 50 1124 382 30 252 329 1428 551 1144 1881 2276 1563 1250
 2324 1582 1230 1452 1529 2628 1751 2344 69 464 2763 2450 512 2782 2430 1206 2729 816 421 532 1269 1664 951 638 1712

970 618 2406 917 2016 1621 1732 2951 2864 2151 1838 2912 2170 1818 594 2117 204 2821 2932 1139 1052 339 26 1100 358
 6 1794 305 1404 1009 1120 2339 2252 1539 1226 2300 1558 122 2994 903 2604 2209 2320 527 440 2739 2426 488 2758 1322
 1182 2103 792 397 508 1727 1640 927 614 1447 946 2522 2382 291 1992 1597 1708 2927 2840 2127 1814 2647 2146 710 570
 1491 1987 2797 2908 1115 1028 315 2773 835 334 1910 1770 2691 175 985 1096 2315 2469 1515 961 2035 1534 98 2970 879
 1375 2185 2296 503 657 2715 2161 223 2734 1298 1158 2079 2575 373 484 1703 1857 1505 349 1423 922 2498 2358 267 763
 1573 1684 2903 45 2705 1549 2623 2122 686 546 1467 1963 2291 2884 1091 1245 893 2749 811 310 1886 180 2667 151 479
 1072 1809 2445 2093 937 2011 1510 74 1380 855 1351 1679 2272 3009 633 281 2137 199 2710 1274 2580 2055 2551 2879 460
 1197 1833 1481 325 1399 898 2474 768 845 739 1067 1660 2397 21 2681 1525 2599 2098 1746 1968 2045 1939 2267 2860 585
 1221 869 2725 787 286 2946 156 233 127 455 1048 1785 2421 2069 913 2228 1486 1134 1356 1433 2532 1655 2248 2985 609
 257 2113 416 2686 2334 2556 2633 720 2855 436 1173 1568 1457 542 1616 874 522 744 821 1920 1043 1636 2373 2768
 2657 1742 2816 2074 1722 1944 2021 108 2243 2836 561 956 243 2942 1004 262 2922 132 209 1308 431 1024 1761 2156
 1443 1130 2204 1462 1110 1332 1409 2508 1631 2224 2961 344 2643 2330 392 2662 2310 1086 2609 696 301 412 1149 1544 831
 518 1592 850 498 2286 797 1896 1501 1612 2831 2744 2031 1718 2792 2050 1698 474 1997 84 2701 2812 1019 932 219 2918
 980 238 2898 1674 185 1284 889 1000 2219 2132 1419 1106 2180 1438 2 2874 783 2484 2089 2200 407 320 2619 2306 368
 2638 1202 1062 1983 672 277 388 1607 1520 807 494 1327 826 2402 2262 171 1872 1477 1588 2807 2720 2007 1694 2527
 2026 590 450 1371 1867 2677 2788 995 908 195 2653 715 214 1790 1650 2571 55 865 976 2195 2349 1395 841 1915 1414
 2990 2850 759 1255 2065 2176 383 537 2595 2041 103 2614 1178 1038 1959 2455 253 364 1583 1737 1385 229 1303 802
 2378 2238 147 643 1453 1564 2783 2937 2585 1429 2503 2002 566 426 1347 1843 2171 2764 971 1125 773 2629 691 190
 1766 60 2547 31 359 952 1973 817 2325 2152 1390 1689 1231 735 1891 2966 1260 1559 161 2017 513 340 2590 2889 2431
 1935 79 1154 2460 2759 1361 205 1713 1540 778 1077 619 725 1279 2354 648 947 2561 1405 2913 2740 1978 2277 1819 1925
 2479 1626 1848 2147 749 2605 1101 928 166 465 7 113 667 2826 36 335 1949 793 2301 2128 1366 1665 2412 1313 2108
 1014 1236 1535 137 1993 489 316 2566 2865 600 2513 296 2214 2436 2735 1337 422 1448 1516 754 1053 1800 701 1496 402
 624 923 2537 1622 2648 2716 1954 2253 3000 1901 2696 1602 1824 2123 123 2822 836 904 142 441 1188 89 884 2802 12 311
 1323 1010 2036 2104 1342 1641 2388 1289 2084 990 1212 1511 2523 2210 224 292 2542 2841 576 2489 272 2190 966 181 711
 398 1424 1492 730 1029 1776 677 1472 378 2166 1381 1911 1598 2624 2692 1930 2711 2976 1877 2672 1578 354 2581 99 2798
 812 880 118 899 1164 65 860 2778 1554 769 1299 986 2012 2080 1318 2099 2364 663 2060 2894 2754 1969 2499 2186 200
 268 2518 287 552 1863 248 1082 942 157 687 374 1400 1468 706 1487 1752 51 1207 2282 2142 1357 1887 1574 2600 2668
 1906 2687 1747 1251 2407 470 330 2557 75 2533 788 856 94 875 2947 2451 595 1670 1530 745 1275 721 2229 2056 1294
 2075 1135 639 1795 2870 2730 1945 2475 1921 417 244 2494 263 2335 1839 2995 1058 918 133 1265 109 1617 1444 682
 1463 523 27 1183 2258 2118 1333 2465 1309 2817 2644 1882 2663 1723 1227 2383 446 306 2051 2509 1005 239 571 2952 2923
 851 2427 70 1646 653 832 697 2205 1439 1771 1140 1111 1569 615 1270 2846 1853 2032 1897 393 2639 2971 2340 2311 2769
 1815 2470 1034 41 220 85 1593 827 1159 528 499 957 605 658 2234 1241 1420 1285 2793 2027 2359 1728 1699 2157 1805
 1858 1506 2441 2620 2485 981 215 547 2928 2899 345 3005 46 2706 629 808 673 2181 1415 1988 1116 2292 1545 1193 1246
 894 1829 2008 1873 369 2615 176 2316 480 2745 2393 2446 2094 17 196 302 1328 803 1376 504 1680 933 581 634 282
 1217 1396 1502 2528 2003 2576 1704 2880 2133 1781 1834 1482 2417 2596 2702 716 191 764 2904 1068 321 2981 22 2682 3 784
 890 1916 1391 1964 1092 2268 1521 1169 1222 870 1203 1984 2090 104 61 152 846 456 2721 2369 2422 2070 2403 172 278
 1304 1261 1352 2046 1656 909 557 610 258 591 1372 1478 2504 2461 2552 234 2856 2591 1757 1810 1458 1791 2572 2678 692
 649 740 1434 1044 779 2957 3010 2658 2991 760 866 1892 1849 1940 2634 2244 1979 543 1198 2774 1179 1960 2066 80 37 128
 822 432 167 1743 2398 962 2379 148 254 1280 1237 1087 2022 1632 1367 2943 586 2162 567 1348 1454 2480 2437 2287 210
 1627 2567 1131 1786 350 1767 2548 2413 668 625 475 1410 2827 755 2331 2986 1550 2967 736 601 2109 1825 1675 2610
 1015 1955 519 1174 2750 1155 1936 1801 297 13 2875 798 2215 143 1719 2374 938 2355 124 3001 1497 1213 1063 1998 403
 1343 2919 562 2138 1145 1324 1931 2524 326 1107 2345 2543 1762 1189 2697 186 2263 1603 119 712 1526 2307 533 731
 2962 2389 885 2832 451 2803 1319 1912 2726 495 1733 1449 1150 577 2085 1020 1651 991 2519 100 914 1695 2933 2649

2350 1777 273 2220 2851 2191 707 1300 2114 485 1121 837 538 2977 1473 408 1039 379 1907 2500 1386 1685 2321 2037
 1738 1165 2673 1608 2239 1579 95 688 2586 2885 509 225 2938 2365 861 2808 427 2779 1295 1888 774 1073 1709 1425 1126
 553 2061 996 1868 2172 2495 76 1974 2273 2909 2625 2326 1753 249 2196 56 360 683 1276 162 461 1097 813 514 182
 1208 384 1256 1560 1883 2476 1362 1661 2297 2013 1714 1382 2408 1584 2456 2760 71 664 2562 2861 2895 201 2914 2582 596
 2784 644 948 1271 1864 750 1049 1083 1401 1102 770 1796 972 1844 2148 2953 52 1950 2249 2283 2601 2302 1970 2996 726
 32 336 1141 1252 138 437 471 789 490 158 1184 1926 1232 1536 2341 2452 1338 1637 1671 2471 1690 1358 2384 114 2432
 2736 529 640 2538 2837 2871 659 2890 2558 572 1314 620 924 1729 1840 2654 423 1059 1859 1078 746 1772 2514 1820
 2124 2929 28 842 1623 2259 47 2278 1946 2972 702 8 312 1117 1228 2042 2823 447 1247 466 134 1160 1902 967 1512 2317
 2428 230 1011 1647 2447 1666 1334 2360 90 2167 1507 505 616 1430 2211 2847 635 2866 2293 548 1290 355 2707 1705 1816
 2630 399 1035 1835 1054 481 1989 2490 1555 895 2905 4 818 1599 2235 23 2254 1681 177 678 2755 2095 1093 1204 2018
 2799 1025 1223 442 2881 1377 1878 943 283 1811 2404 206 987 2225 2423 1642 1069 2577 66 2143 1483 3011 592 1406 2187
 413 611 2842 2269 765 2712 331 2683 1199 1792 2606 375 1613 1329 1030 457 1965 900 1531 871 2399 2992 794 1575
 2813 2529 2230 1657 153 2100 2731 2071 587 1180 1994 365 1001 717 418 2857 1353 288 919 259 1787 2380 1266 1565
 2201 1917 1618 1045 2553 1488 2119 1459 2987 568 2466 2765 389 105 2818 2245 741 2688 307 2659 1175 1768 654 953
 1589 1305 1006 433 1941 876 1748 2052 2375 2968 1854 2153 2789 2505 2206 1633 129 2076 2948 240 563 1156 42 341 977
 693 394 62 1088 264 1136 1440 1763 2356 1242 1541 2177 1893 1594 1262 2288 1464 2336 2640 2963 544 2442 2741 2775 81
 2794 2462 476 2664 524 828 1151 1744 630 929 963 1281 982 650 1676 852 1724 2028 2833 2944 1830 2129 2163 2481
 2182 1850 2876 606 2924 216 1021 1132 18 317 351 669 370 38 1064 1806 1112 1416 2221 2332 1218 1517 1551 2351 1570
 1238 2264 3006 2312 2616 409 520 2418 2717 2751 539 2770 2438 452 1194 500 804 1609 1720 2534 303 939 1739 958 626
 1652 2394 1700 2004 2809 2920 722 1503 2139 2939 2158 1826 2852 582 2900 192 997 1108 1922 2703 327 1127 346 14 1040
 1782 847 1392 2197 2308 110 891 1527 2327 1546 1214 2240 2982 2047 1387 385 496 1310 2091 2727 515 2746 2173 428
 1170 235 2587 1585 1696 2510 279 915 1715 934 361 1869 2370 1435 775 698 2915 2635 1975 2785 57 2134 558 2115 1479
 1561 2896 1898 1103 823 163 973 1257 322 1758 905 2679 2761 1084 86 2303 2023 1363 1691 2457 1522 2958 2105 867 949
 2284 1286 491 211 2563 2891 645 2722 2592 293 2067 2149 472 2486 1209 1411 751 1079 1845 910 780 1493 255 337
 1672 674 2409 2611 1951 2279 33 2110 1980 2693 1455 1537 2872 1874 597 799 139 467 1233 298 168 881 245 2737 1060
 1146 1797 1999 1339 1667 2433 1498 1368 2081 1445 925 2260 2346 2997 187 2539 2867 621 2698 2568 269 2645 2125 448 534
 1185 1628 1932 1055 1821 886 756 1469 833 313 1648 1734 2385 2828 120 2255 9 2086 1956 2669 2033 1513 2848 2934 573
 1016 1320 443 968 274 144 857 221 2954 1036 1122 1773 2216 2520 1643 2168 1474 1344 2057 1421 1142 2236 2322 2973 404
 708 2843 356 2674 2544 2655 2621 2342 424 510 1161 1604 1908 1031 1556 862 732 843 809 530 1624 1710 2361 2804 96
 2713 2756 2062 486 2043 2009 1730 2824 2910 549 992 1296 901 944 250 1686 231 197 2930 1012 1098 2231 2192 2496
 2101 2144 1450 2886 1431 1397 1118 2212 2298 419 380 684 289 332 2650 1074 2631 2597 2318 400 2414 1619 1580 1884
 1489 1532 838 2274 819 183 506 1600 602 2819 2780 72 2689 2732 2038 462 2019 1383 1706 2800 1802 1007 727 1272 877
 920 226 1662 207 2583 2906 988 3002 2207 1927 1267 2077 2120 1426 2862 1407 771 1094 2188 1190 395 115 2467 265 308
 2626 1050 2607 1971 2053 376 2390 1595 1315 655 1465 1749 814 2250 795 159 241 1576 578 2795 2515 1855 2665 2949
 2014 438 1995 1359 1441 2776 1778 983 703 43 853 1137 202 1638 785 2559 2641 964 2978 2183 1903 1243 1571 2337 1402
 2838 1985 747 829 2164 1166 371 91 2443 2771 525 2602 2472 173 1947 2029 352 2366 1089 1291 631 959 1725 790 660
 1373 135 217 1552 554 2289 2491 1831 2159 2925 1990 1860 2573 1335 1417 2752 1754 477 679 19 347 1113 178 48 761 125
 2617 940 1026 1677 1879 1219 1547 2313 1378 1248 1961 1325 805 2140 2226 2877 67 2419 2747 501 2578 2448 149 2525 2005
 328 414 1065 1508 1812 935 1701 766 636 1349 713 193 1528 1614 2265 2708 0 2135 2901 1966 1836 2549 1913 1393 2728
 2814 453 896 1200 323 848 154 24 737 101 2593 916 1002 1653 2096 2400 1523 2048 1354 1224 1937 1301 1022 2116 2202
 2853 284 588 2723 236 2554 2424 2535 2501 2222 304 390 1041 1484 1788 911 1436 742 612 723 689 410 1504 1590
 2241 2684 2988 2111 2636 1942 366 1923 1889 1610 2704 2790 429 872 1176 781 824 130 1566 111 77 2810 892 978 1629
 2072 2376 1981 2024 1330 2766 1311 1277 998 2092 2178 299 260 564 169 212 2530 954 2511 2477 2198 280 2294 1499

1460 1764 1369 1412 718 2154 699 665 386 1480 482 2699 2660 2964 2569 2612 1918 342 1899 1263 1586 2680 1682 887 607
1152 757 800 106 1542 87 2463 2786 868 2882 2087 1807 2352 1957 2000 1306 2742 1287 651 974 2068 1070 275 3007 2347
145 188 2506 930 2487 1851 2174 256 2270 1475 1195 535 1345 1388 694 2130 675 39 121 1456 458 2675 2395 1735 2545
2829 1894 318 1875 1239 1321 2656 1658 863 583 2935 733 1017 82 1518 63 2439 2521 844 2858 2063 1783 1123 1933 2217
1282 2718 1865 627 709 2044 1046 251 2983 2323 2651 405 2482 906 53 1827 1909 232 2246 1451 1171 511 839 1605 670
540 1253 15 97 1432 434 2169 2371 1711 2039 2805 1870 1740 2453 1215 1297 2632 1634 357 559 2911 227 993 58 2940 641
2415 2497 820 2834 1557 1759 1099 1427 2193 1258 1128 1841 1205 685 2020 2106 2757 2959 2299 2627 381 2458 2328 29 2405
1885 208

Annex C (normative): CPM Phase response samples

In reference to clause 7.3.7.2.1, the samples of the phase response function $q_{AV}(t)$ are tabulated for $\alpha_{RC} = 0,98, 0,75$ and $0,625$.

Table C-1: CPM Phase response function

t/T_s	$q_{AV}(t) : \alpha_{RC} = 0,98$	$q_{AV}(t) \alpha_{RC} = 0,75$	$q_{AV}(t) \alpha_{RC} = 0,625$
0	0	0	0
0,0312	0,0002	0,002	0,0029
0,0625	0,0004	0,004	0,0059
0,0938	0,0008	0,0061	0,009
0,125	0,0014	0,0084	0,0122
0,1562	0,0023	0,0109	0,0156
0,1875	0,0036	0,0137	0,0192
0,2188	0,0052	0,0168	0,0231
0,25	0,0074	0,0203	0,0273
0,2812	0,0101	0,0242	0,0319
0,3125	0,0133	0,0285	0,0368
0,3438	0,0172	0,0333	0,0421
0,375	0,0217	0,0386	0,0478
0,4062	0,027	0,0445	0,054
0,4375	0,0329	0,0509	0,0606
0,4688	0,0396	0,0578	0,0677
0,5	0,0471	0,0654	0,0753
0,5312	0,0553	0,0735	0,0834
0,5625	0,0642	0,0821	0,0919
0,5938	0,0739	0,0914	0,1009
0,625	0,0843	0,1012	0,1104
0,6562	0,0954	0,1115	0,1203
0,6875	0,1071	0,1223	0,1306
0,7188	0,1195	0,1336	0,1413
0,75	0,1325	0,1454	0,1524
0,7812	0,1459	0,1575	0,1638
0,8125	0,1599	0,1701	0,1756
0,8438	0,1743	0,1829	0,1876
0,875	0,189	0,196	0,1998
0,9062	0,204	0,2093	0,2122
0,9375	0,2193	0,2228	0,2247
0,9688	0,2347	0,2364	0,2374
1	0,2501	0,2501	0,2501
1,0312	0,2656	0,2638	0,2628
1,0625	0,281	0,2774	0,2754
1,0938	0,2962	0,2909	0,2879
1,125	0,3112	0,3042	0,3004
1,1562	0,3259	0,3173	0,3126
1,1875	0,3403	0,3301	0,3246
1,2188	0,3543	0,3426	0,3363
1,25	0,3677	0,3548	0,3477
1,2812	0,3807	0,3665	0,3588
1,3125	0,3931	0,3778	0,3695
1,3438	0,4048	0,3886	0,3799
1,375	0,4159	0,399	0,3898
1,4062	0,4263	0,4087	0,3992
1,4375	0,4359	0,418	0,4082
1,4688	0,4449	0,4266	0,4167
1,5	0,453	0,4347	0,4248
1,5312	0,4605	0,4422	0,4323
1,5625	0,4672	0,4492	0,4394

t/T_s	$q_{AV}(t) : \alpha_{RC} =$ 0,98 $q_{AV}(t)\alpha_{RC} = 0,98$	$q_{AV}(t) \alpha_{RC} = 0,75$	$q_{AV}(t) \alpha_{RC} = 0,625$
1,5938	0,4731	0,4556	0,4461
1,625	0,4783	0,4614	0,4522
1,6562	0,4829	0,4667	0,4579
1,6875	0,4867	0,4715	0,4632
1,7188	0,49	0,4758	0,4681
1,75	0,4927	0,4797	0,4727
1,7812	0,4948	0,4832	0,4769
1,8125	0,4965	0,4863	0,4808
1,8438	0,4977	0,4891	0,4844
1,875	0,4986	0,4916	0,4878
1,9062	0,4992	0,4939	0,491
1,9375	0,4996	0,496	0,4941
1,9688	0,4998	0,498	0,4971

Annex D (informative): Bibliography

- Recommendation ITU-T Q.2931 (1995): "Digital Subscriber Signalling System No. 2 User-Network Interface (UNI) layer 3 specification for basic call/connection control".
- Recommendation ITU-T I.432 (all parts): "B-ISDN user-network interface - Physical layer specification".
- ETSI ES 200 800: "Digital Video Broadcasting (DVB); DVB interaction channel for Cable TV distribution systems (CATV)".
- IETF RFC 2104 (1997): "HMAC: Keyed-Hashing for Message Authentication".
- ISO/IEC 13818-6 (1998): "Information technology - Generic coding of moving pictures and associated audio information - Part 6: Extensions for DSM-CC".
- ETSI EN 301 427: "Satellite Earth Stations and Systems (SES); Harmonized EN for Low data rate Mobile satellite Earth Stations (MESs) except aeronautical mobile satellite earth stations, operating in the 11/12/14 GHz frequency bands covering essential requirements under article 3.2 of the R&TTE Directive".
- ETSI EN 301 358: "Satellite Earth Stations and Systems (SES); Satellite User Terminals (SUT) using satellites in geostationary orbit operating in the 19,7 GHz to 20,2 GHz (space-to-earth) and 29,5 GHz to 30 GHz (earth-to-space) frequency bands".
- Recommendation ITU-T I.363-5 (1996): "B-ISDN ATM Adaptation Layer specification: Type 5 AAL".
- IETF RFC 4326: "Unidirectional Lightweight Encapsulation (ULE) for Transmission of IP Datagrams over an MPEG-2 Transport Stream (TS)".
- IETF RFC 2684 (1999): "Multiprotocol Encapsulation over ATM Adaptation Layer 5".
- ETSI TR 100 815: "Digital Video Broadcasting (DVB); Guidelines for the handling of Asynchronous Transfer Mode (ATM) signals in DVB systems".
- Recommendation ITU-T X.509 (2008): "Information Technology - Open Systems Interconnection - The Directory: Public-key and attribute certificate frameworks".
- J. G. Proakis, 4th ed. McGraw-Hill, New York, USA, 2001: "Digital Communications".
- D. Divsalar and F. Pollara, in. Proc. ICC, Seattle, Washington, pp. 54-59, June 18-22, 1995: "Turbo codes for PCS applications".
- P. Moqvist and T. Aulin, IEEE Trans. Commun., vol. 49, no. 11, pp. 1901-1915, August 2002: "Serially concatenated continuous phase modulation with iterative decoding".
- B. E. Rimoldi, IEEE Trans. Inform. Theory, vol. 34, no. 2, pp. 260-270, March 1988: "A decomposition approach to CPM".
- A. Barbieri and G. Colavolpe, IEEE Trans. Wireless Commun., vol. 6, no. 7, pp. 2486-2496, July 2007: "Simplified soft-output detection of CPM signals over coherent and phase noise channels".
- L. R. Bahl, J. Cocke, F. Jelinek, and J. Raviv, IEEE Trans. Info. Theory, vol. IT-20, no. 2, pp. 284-287, March 1974: "Optimal decoding of linear codes for minimizing symbol error rate".
- P. Moqvist, and T. Aulin, IEEE Electronics Letters, vol. 36, no. 23, pp. 1940-1941, November 2000: "Trellis termination in CPM".

History

Document history		
V1.1.1	January 2012	Publication
V1.2.1	April 2014	Publication
V1.3.0	April 2020	EN Approval Procedure AP 20200723: 2020-04-24 to 2020-07-23
V1.3.1	July 2020	Publication
Draft V1.4.1	July 2023	BlueBook A155-2r3 publication. Added: <ul style="list-style-type: none"> - Signalling for non-geosynchronous satellites (non-GSO) and for forward links using Annex E (superframes) of DVB-S2X used by multibeam satellites, for interference suppression, pre-coding and beam-hopping - Additional signalling relevant for beam-hopping systems